



Catalogue

# Foodservice



English 2024

# Index

<b>FagorKonnect.....</b>	<b>07</b>	<b>Distribution.....</b>	<b>377</b>
<b>Cooking.....</b>	<b>13</b>	— Drop-in.....	379
— Symphony.....	11	— Self-service.....	397
— Kore Monoblock.....	21	— Trolleys for distribution.....	413
— Kore 900.....	29	<b>Static preparation.....</b>	<b>425</b>
— Kore 700.....	61	— Sinks, hand basins, professional	
— Independent cooking.....	93	faucets and.....	427
— Large capacity cooking equipment.....	101	— Work tables and cabinets.....	447
<b>Ovens.....</b>	<b>121</b>	— Neutral-hot element composition.....	469
— Compact ovens-iKORE Kompact.....	129	— Bar elements.....	491
— Industrial combi ovens - iKORE.....	133	— Shelving.....	497
— Vacuum packers.....	161	<b>Extraction.....</b>	<b>515</b>
— Set-ups.....	163	— Extraction hoods.....	518
— Other accessories.....	167	<b>Annexes.....</b>	<b>531</b>
<b>Dishwashing.....</b>	<b>171</b>		
— Glasswasher.....	175		
— Front loading dishwashers.....	183		
— Hood-type dishwashers.....	193		
— Utensilwashers.....	205		
— Rack conveyor.....	209		
— Flight type dishwashers.....	227		
— Dishwasher accessories.....	239		
<b>Commercial refrigeration.....</b>	<b>243</b>		
— Refrigerated cabinets.....	250		
— Refrigerated Counters.....	281		
— Preparation counters.....	311		
— Blast chillers.....	327		
— Bar line.....	339		
— Wine cellars & meat dry agers.....	355		
— Ice makers.....	365		



**Foodservice**



COOKING



OVENS



DISHWASHING



COMMERCIAL  
REFRIGERATION



DISTRIBUTION



STATIC  
PREPARATION



**Laundry**



PROFESSIONAL  
LAUNDRY



WASHING



DRYING



IRONING  
AND FOLDING



FINISHING



SOLUTIONS

**What do we offer you?**

A range of products  
under the same brand.  
A universe of services  
professionals.



Cooking



Ovens

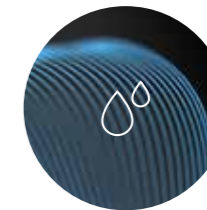

Dishwashing



Commercial  
refrigeration

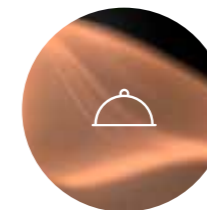

Distribution



Static preparation

A global brand, close to you,  
wherever you are.

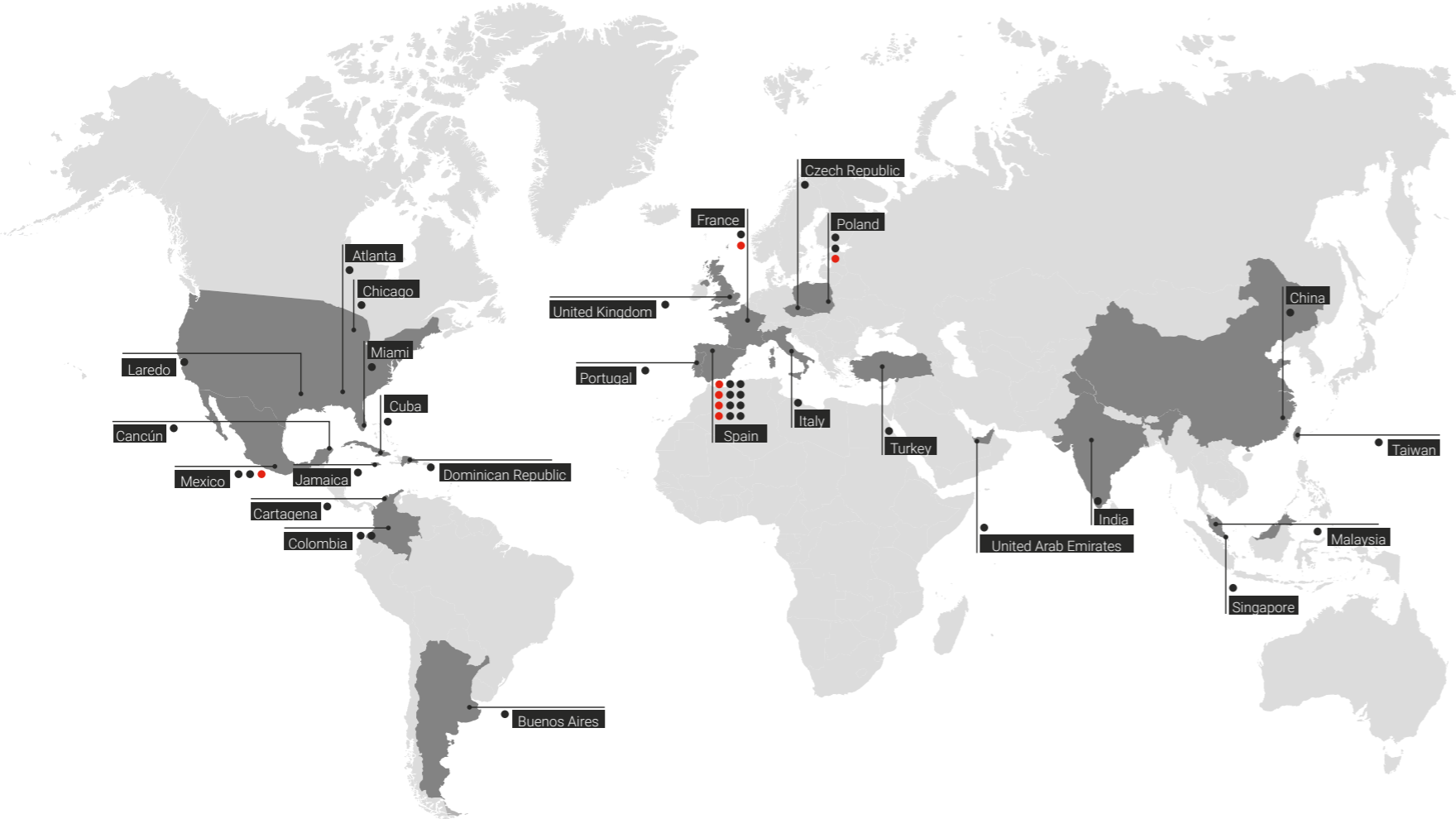

● Sales delegations  
● Own-manufacture plants

Our 35 offices distributed around the world, the professionalism of our 2,200 workers and our international experience help us to always remain close to you, to your needs, to your projects.

But, above all, our implication, our commitment to service and our way of directly interacting with those around us, from professional to professional, means that we use the same language when responding to your challenges with the proximity of a major brand.

**Wherever you are.**





 **FagorKonnnect**

Imagine having  
everything konnected...

# Getting the most out of your kitchen from wherever and whenever you want. Now it is possible.

- Digitalize your Kitchen
- Send and receive information
- From a single application



We believe in a more sustainable world

FagorKonnnect helps you to have very useful information to improve efficiency and also reduces travel, generating less pollution and lower consumption.

01

## Absolute control

Manage and monitor your business at a glance, customizing the dashboard with total freedom. Remotely monitor and gain absolute control of your business at your fingertips.



02

## Efficient business

Analyze the operation of all your equipment to optimize its use and make your processes more efficient. Save on costs and increase your income thanks to a in real time vision and over time monitoring.

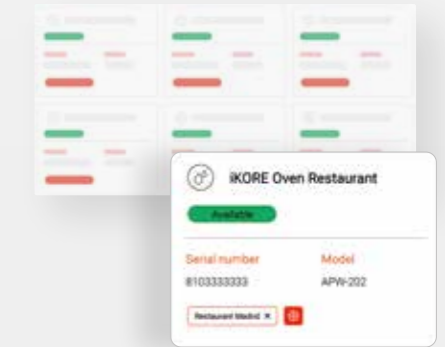

03

## Ensure processes

Have the peace of mind of ensuring all hygiene and food safety requirements having easily recorded in digital format all the data you need.

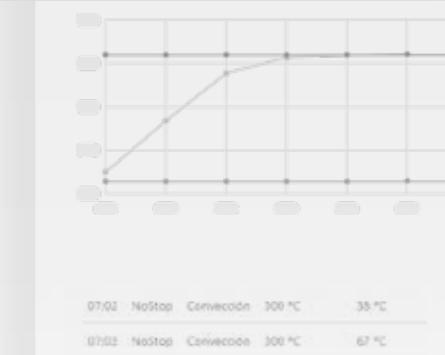

04

## Improve your service

You will see the incidents, receive warnings and get all the necessary information to be able to anticipate. That way, you make sure your equipment is out of service for as little time as possible and avoid confusing communications with the technical service.

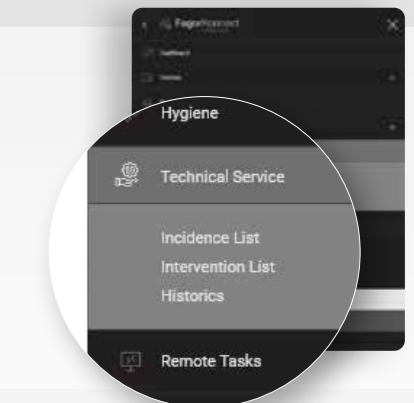

05

## Gain comfort

Save time thanks to remote functions and recipes management as well as gaining in security thanks to the warning messages. Conveniently manage all your devices anytime, anywhere, on any device.



Watch the video







Cooking





# Cooking

Symphony .....	016
KORE Monoblock.....	022
KORE Modular	
— 900 Series.....	029
— 700 Series.....	061
Independent cooking.....	094
Large capacity cooking equipment .....	114



# Symphony

Symphony offers you the possibility to design and personalise your kitchen with complete freedom, based on your operating needs, combining the different elements, devices and accessories available, symphony will solve and optimise any space.



A free expression kitchen,  
tailored to your needs



Access the website

# Symphony

## The composition of a perfect symphony

The Symphony range of kitchens enables the kitchen professional to design a tailor-made commercial kitchen with complete freedom, arranging and adapting its various components to suit their style of working.

A wide range of excellent design, high-quality components, shapes, sizes, complements and finishes, which let's you customise is the ideal solution to enjoy cooking and delight the most demanding of palates.

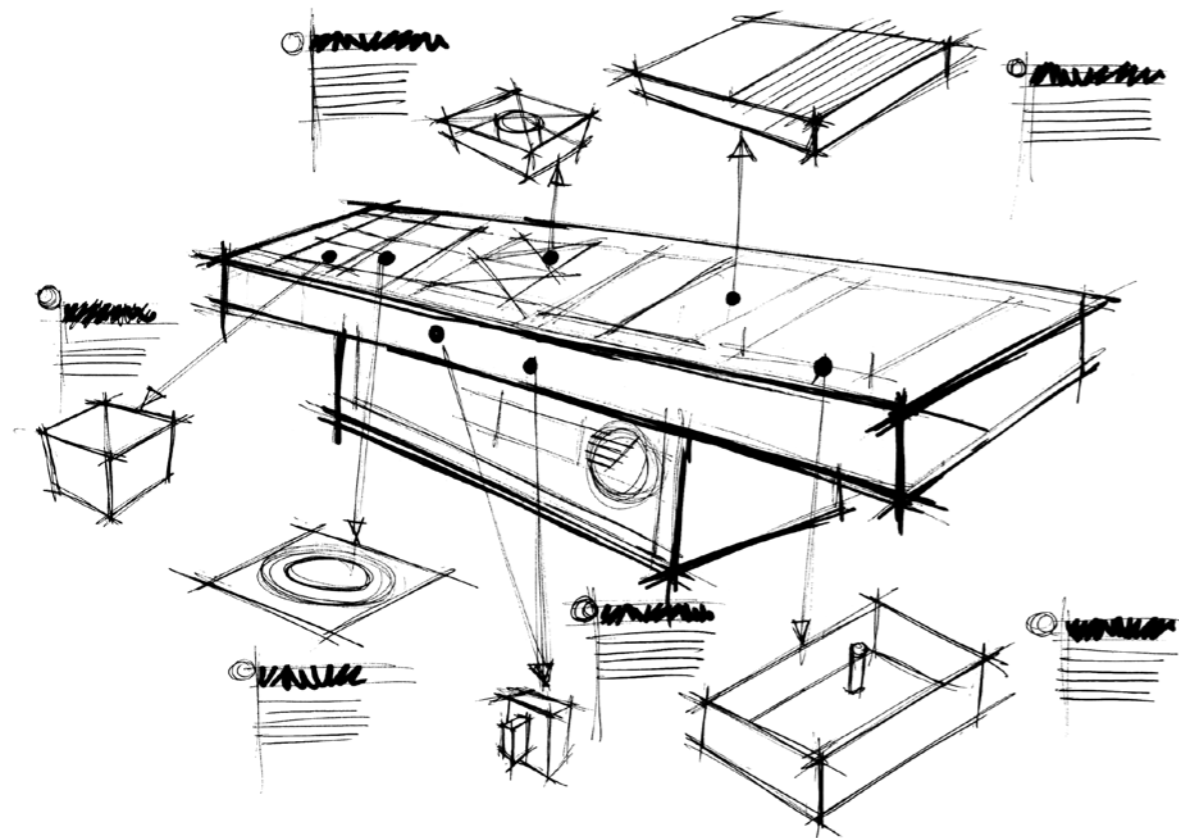

## Every chef's dream.

The Symphony range has been created to offer design and functional solutions to meet the requirements of kitchen professionals. Elegant, versatile, high powered and high-quality, it is designed by and for the most demanding professionals.

In addition to this, a multitude of advantages that enable optimisation of the available space and management of the work in the kitchen in an effective way according to the chef's tastes and style of working.

Space optimisation

Absolute comfort

Robust and available in a variety of finishing materials

Maximum safety

Optimised performance

Easy to clean





# Main differences between Symphony and KORE Monoblock

	SYMPHONY	KORE Monoblock
<b>Connections</b>	Centralized connections	Individual connection. Optional a module in which to centralize all the connections.
<b>Thickness</b>	3 mm (+ 3 mm reinforcement)	KORE 900: 2mm KORE 700: 1,5mm
<b>Customization</b>	Endless options	Unique aesthetic front panel, side finishes and coloured controls available.
<b>Configuration (functionalities)</b>	Made to measure design process.	Exceptions: - Worktop height = 900mm - Not possible to integrate boiling and bratt pans. - Maximum length = 5 modules. - Special brass open burners - Special fry-tops with water channel and drain system integrated in countertop.
<b>Design and quoting process</b>	Made to measure design process.	Easily achievable design.
<b>Transport</b>	It can be shipped the way you need it. The "tailor-made" applies to shipping as well.	Standard packaging. No welding or no on-site welding or polishing in situ.  Each wall block is a package (the central blocks are divided into two packages). Verticality is shipped separately.
<b>Availability</b>	On request. Custom manufacturing book and build.	Fast availability, on request. Manufacturing based on modular equipment which speeds up manufacturing.

## Tailor-made kitchen: Symphony

The composition of a perfect Symphony



## One piece worktop kitchen: KORE Monoblock

A unique solution for your kitchen





# KORE Monoblock

KORE Monoblock is a unique worktop designed to offer all the benefits of our modular equipment and highlight its capabilities.

Main features .....	<b>023</b>
How to build your block.....	<b>025</b>
Example .....	<b>025</b>
Differences .....	<b>027</b>



A unique solution  
for your kitchen



Access the website



Folleto comercial

## A unique solution for your kitchen

The KORE Monoblock range has been designed to offer all the benefits of our modular units; combined in a single worktop that also brings great advantages.

Configuring the ideal block is easier than ever, thanks to the possibility of combining the modular units of the **KORE 900 and KORE 700 range** as you wish.

The worktop is designed as one single piece, without joints or gaps, so you can ensure an impeccable level of cleaning. All of this is in addition to an elegant aesthetic that is intricately designed to draw everyone's attention. A solution that guarantees optimum hygiene and durability for your equipment, thanks to its robust design created to withstand intensive work levels and offer maximum performance.

## The perfect worktop for your kitchen

KORE Monoblock offers integration and functionality and is the ideal finish for your workspace. The perfect worktop to bring your kitchen together in the same style, making it look more impressive.



Wide range of products

---

Availability

---

Cost

---

Product certifications

---

Hygiene and cleaning

---

Robust design

---

Easy installation

---

Ergonomics and versatility

---

Attractive

---

# Choose the configuration that suits your menu best

## 1

### Block type

Whether you're looking for an island because you have plenty of available space, or you'd prefer a worktop against the wall so you can make the most of your limited space, our solutions are designed to meet all your expectations.

### Choose the type of block

#### Kore Monoblock 900

CODE : 18006781

##### Central



##### Wall



#### Kore Monoblock 700

CODE : 18007031

##### Central



##### Wall



#### Kore Monoblock 900+700

CODE : 18007032

##### Central



## 2

### On worktop

#### Select the equipment for your worktop

Choose the equipment you'd like to include in your kitchen worktop. You can choose from a wide range of products within our KORE 900 and KORE 700 range.



## 3

### Under worktop

#### Select elements under the worktop

Complete your design by adding the equipment under your worktop. You can add neutral stands to store elements that are not being used, so they are organised and you optimise your kitchen space. You can also include refrigerated stands to have the refrigerated food ready.



## 4

### Verticality

#### Select elements to go above your worktop

Choose the supports that best suit your needs (standard, with tap, with plug or special supports for machinery like iKORE 0623 ovens or salamanders) and the corresponding racks in between.



## 5

### Finishes

#### Select side-panels to complete the block

Add side-finishes to improve aesthetics, hygiene and ergonomics.



### End result

#### Real block configuration example

#### Side A KORE 900



#### Side B KORE 700



### Verticality

### Summary

MODELO	DESCRIPCIÓN	CANTIDAD
<b>On worktop</b>		
EN-905	1/2 Module neutral element	1
CP-E910	Pasta cooker	1
EN-910	1 Module neutral element	1
C-G940 LPG	4 burners gas cooker	1
<b>Under worktop</b>		
MB-905	1 Module stand	2
CCP9-2G	Refrigerated stand with doors	1

MODELO	DESCRIPCIÓN	CANTIDAD
<b>On worktop</b>		
F-E7115	Fryer	1
EN-7025	1/4 Module neutral element	1
FT-E7125	Smooth & chromed fry-top	1
EN-705	1/2 Module neutral element	1
C-I745	4 cooking areas induction	1
<b>Under worktop</b>		
MB-715	1.5 Module stand	1
CCP7-2G W	Refrigerated stand with drawers	1

MODELO	DESCRIPCIÓN	CANTIDAD
S2	Support with tap	2
R	Rack	1
LAT	Side-finishes	2

DESCRIPTION	DIMENSIONS (mm)	€
KORE Monoblock 900/700, 3.5M	2.980 x 1760 x 900	-



## Main differences between KORE Monoblock and KORE Modular

	KORE MONOBLOCK	KORE MODULAR
<b>Connections</b>	One connection for each machine. Centralized connections module available.	One connection for each machine.
<b>Thickness</b>	900: 2 mm + reinforced structure 700: 1,5 mm + reinforced structure	900: 2 mm 700: 1,5 mm
<b>Customization</b>	Endless options  Aesthetical single front panel, side-finishes and coloured controls available	Coloured controls available  There are no customization options.
<b>Configuration (functionalities)</b>	Exceptions: - Worktop height = 900mm - Not possible to integrate boiling and bratt pans. - Maximum length = 5 modules. - Special gas cookers with brass burner crowns and drainage system - Special fry-tops with bigger surface, water channel and drainage system.	Wide range of products, limited to specific limitations per unit.
<b>Design and quotation process</b>	Easily achievable design.  Online configurator .	Set price per product unit
<b>Transport</b>	Each wall block is a package (central blocks are divided into two walls). Verticality is sent separately. Standard packaging. No welding or polishing needed in situ.	Each machine is shipped with its packaging.
<b>Price</b>	+ 25-30% compared to the KORE Modular range.	
<b>Availability</b>	Quick availability, on request. Manufacturing based on modular equipment that streamlines manufacturing. Estimated delivery time of 3 weeks.	Fast delivery. Stocked products.

### KORE Monoblock

A unique solution for your kitchen



### KORE Modular

Wide variety and maximum quality



# 900 Series

Gas cookers.....	<b>031</b>
Gas solid tops.....	<b>033</b>
Paella cookers.....	<b>034</b>
Electric cookers.....	<b>035</b>
Electric solid tops with 4 cooking zones.....	<b>036</b>
Induction cookers.....	<b>037</b>
Pasta cookers.....	<b>038</b>
Fry-tops.....	<b>039</b>
Fryers.....	<b>041</b>
Grills.....	<b>043</b>
Boiling pans.....	<b>045</b>
Tiling bratt pans.....	<b>047</b>
Bain marie.....	<b>048</b>
Chips scuttle.....	<b>049</b>
Neutral elements.....	<b>050</b>
Stands.....	<b>051</b>
Refrigerated stands.....	<b>052</b>
Configuration and finishings.....	<b>053</b>
Accessories.....	<b>059</b>

All gas cooking equipment should be fitted with gas governors:  
 - LPG: 37 g/cm<sup>2</sup>  
 - Natural Gas: 20 g/cm<sup>2</sup>



Performance and  
productivity  
maximised.



Access the website



Commercial video



Sales brochure



# Gas cookers



## General characteristics

- Stamped surface tops, manufactured in 2 mm thick AISI-304 stainless steel.
- Laser-cut joints, automatic welding and polished.
- Hobs with dimensions 397 x 350 mm allowing the use of large pans and pots. The shortened distance between the central prongs, 75 mm, allows them to support pans with a very small diameter (8 cm). This also avoids the danger of small containers tipping over.
- The hobs are manufactured in RAAF enamelled cast iron (resistant to acid and alkali products, fire and high temperatures).
- Double crown burners and diffusers in nickel-plated cast iron, guaranteeing the even distribution of heat from the flame in the bottom of the pans, even large ones. This avoids the accumulation of heat at a single point and optimises the energy transfer of the product.
- Burners with different power ratings to adapt to the containers and their use with different foodstuffs:
  - 5,25 kW (Ø 100 mm),
  - 8,0 kW (Ø 120 mm)
  - 10,2 kW (Ø 140 mm).

- Reassemble with easy slot burners.
- Low consumption pilots and thermocouples positioned within the body of the burner for greater protection.
- Gas conduction in flexible stainless steel tubes, making internal manipulation easier and facilitating any repair work.
- Controls set on a protective base with a system against water infiltration.
- High temperature enamelled cast iron flue protector aligned with the hobs, facilitating manoeuvrability and supporting larger containers, increasing useful surface area.
- Access to the components from the front.

### OVEN

- Option to choose between a GN 2/1 static oven with dimensions of 1,000x700x290mm (OP version cookers); or an electrical oven with GN 2/1 dimensions.
- User-friendly controls set on the upper panel for better ergonomics.
- Stainless steel cooking chamber, making it easier to clean and ensuring a better level of hygiene.
- Tray inserted sideways, making it more user-friendly.
- Guide rails at three levels which offers different usage options.

- Guides rails with "U" shape to prevent the racks from tipping.
- Temperature controlled by thermostatic valve (125 – 310 °C).
- Heating:
  - Gas: Stainless steel tube burner (two branches in OP version), with pilot flame, thermocouple, and Piezo electric ignition.
  - Electric: Heating via stainless steel covered elements with selector switch to control the upper and/or lower zones.
- Oven floor made from 6 mm cast iron, which guarantees better performance and even heat distribution.
- Fibre glass closing seal that improves the thermal efficiency of the oven and guarantees durability.
- Detachable oven door which makes repairs easier.

### OPTIONAL ACCESSORIES

- (see accessories page at end of chapter)
- Plate to place over 5,25 kW burners.
- Water column.
- Brass transmitters.

	MODEL	GAS	CODE	GRILLS (mm)	BURNERS			OVENS		TOTAL POWER (KW)	DIMENSIONS (mm)	€
					5,25 KW	8,0 KW	10,2 KW	SIZE	POWER(kw)			
<b>Countertop</b>												
⊙ STOCK	C-G920	LPG	19075525	397x350	1	1	-	-	-	13,25	400x930x290	-
		NG	19075526									
⊙ STOCK	C-G920 H	LPG	19075521	397x350	-	1	1	-	-	18,20	400x930x290	-
		NG	19075523									
	C-G920 XH	LPG	19085164	397x350	-	-	2	-	-	20,40	400x930x290	-
		NG	19085165									
⊙ STOCK	C-G940	LPG	19075531	397x350	2	1	1	-	-	28,70	800x930x290	-
		NG	19075532									
⊙ STOCK	C-G940 H	LPG	19075527	397x350	-	3	1	-	-	34,20	800x930x290	-
		NG	19075529									
	C-G940 XH	LPG	19085166	397x350	-	-	4	-	-	40,80	800x930x290	-
		NG	19085167									
⊙ STOCK	C-G960	LPG	19075543	397x350	3	2	1	-	-	41,95	1200x930x290	-
		NG	19075544									
⊙ STOCK	C-G960 H	LPG	19075539	397x350	-	5	1	-	-	50,20	1200x930x290	-
		NG	19075541									
<b>GN 2/1 Static gas oven</b>												
⊙ STOCK	C-G941	LPG	19075537	397x350	2	1	1	GN-2/1	8,60	37,30	800x930x850	-
		NG	19075538									
	C-G941 H	LPG	19075533	397x350	-	3	1	GN-2/1	8,60	42,80	800x930x850	-
		NG	19075535									
	C-G941 XH	LPG	19085168	397x350	-	-	4	GN-2/1	8,60	49,40	800x930x850	-
		NG	19085169									
⊙ STOCK	C-G961	LPG	19075549	397x350	3	2	1	GN-2/1	8,60	50,55	1200x930x850	-
		NG	19075550									
	C-G961 H	LPG	19075545	397x350	-	5	1	GN-2/1	8,60	58,80	1200x930x850	-
		NG	19075547									
<b>Panoramic static gas oven</b>												
⊙ STOCK	C-G961 OP	LPG	19075555	397x350	3	2	1	1.000x700x290	14,00	55,95	1200x930x850	-
		NG	19075556									
	C-G961 OP H	LPG	19075551	397x350	-	5	1	1.000x700x290	14,00	64,20	1200x930x850	-
		NG	19075553									
<b>GN 2/1 Static electric oven</b>												
	C-GE941	LPG	19075559	397x350	2	1	1	GN-2/1	6,00	34,70	800x930x850	-
		NG	19075572									

MODELS: H: With high power burners. / OP: With panoramic oven.

## Gas solid tops



### General characteristics



- Stamped surface tops manufactured in 2 mm thick AISI-304 stainless steel.
- Laser-cut joints, automatic welding and polished.
- 10 mm thick cast iron plate with rounded corners. 300 mm diameter surface.
- Refractory brick with cast iron shield inside to take better advantage of the heat and distribute it better.
- Temperatures for differentiated use: 500 °C at the centre and 200 °C near the edges.
- Low consumption pilot and thermocouple.
- Gas conduction in flexible stainless steel tube, making internal manipulation easier and facilitating any repair work.
- Controls set on a protective base with system against water infiltration.

- High temperature enamelled cast iron flue protector aligned with the hobs, facilitating manoeuvrability and support of the containers, increasing the useful surface area.
- Access to the components from the front.

#### OVEN

- Easy to use static GN 2/1 size oven, with the controls positioned on the upper panel.
- Stainless steel cooking chamber, making it easier to clean and provides better hygiene.
- Tray introduced sideways, making it easier to handle.

- Guides at three heights to offer different working options.
- Guides with "U" shape to prevent the trays from tipping.
- Temperature controlled by thermostatic valve (125 – 310 °C).
- Tubular stainless steel burner, with pilot and thermocouple, and piezoelectric ignition.
- Oven floor manufactured in 6 mm cast iron, guaranteeing better performance and even heat distribution.
- Fibreglass closing seal to improve the oven's thermal efficiency.

MODEL	GAS	CODE	SOLID TOP (mm)	BURNERS		OVEN		TOTAL POWER (KW)	DIMENSIONS (mm)	€
				11,0 KW		DIMENSIONS	POWER (KW)			
<b>Solid top</b>										
	C-G910	LPG	19075517	800x700	1	-	-	11,00	800x930x290	-
		NG	19075518							
<b>Solid top with oven</b>										
	C-G911	LPG	19075519	800x700	1	GN-2/1	8,60	19,60	800x930x850	-
		NG	19075520							

## Paella cookers



### General characteristics



- Stamped surface tops manufactured in 2 mm thick AISI-304 stainless steel.
- Laser-cut joints, automatic welding and polished.
- Double crown burner with four rows of flames in each, guaranteeing the even distribution of heat from the flame to the bottom of the paella pan.
- Low consumption pilot and thermocouple.
- Gas conduction in flexible stainless steel tube, making internal manipulation easier and facilitating any repair work.
- Controls set on a protective base with system against water infiltration.

- High temperature enamelled cast iron flue protector aligned with the hobs, facilitating manoeuvrability and support of the containers, increasing the useful surface area.
- Access to the components from the front.

#### PAELLA OVEN

- 665 x 665 x 325 mm static paella oven, with the controls located on the top panel.
- Stainless steel cooking chamber, making it easier to clean and provides better hygiene.

- Temperature controlled by thermostatic valve (125 – 350°C).
- Tubular stainless steel burner at the front; operates with temperature gradient. Pilot with piezoelectric ignition and thermocouple.
- Oven floor manufactured in stainless steel.
- Side opening double panel door.

MODEL	GAS	CODE	BURNERS		POWER (KW)	OVEN		TOTAL POWER (KW)	DIMENSIONS (mm)	€
			Ø OUTER CROWN (mm)	Ø INNER CROWN (mm)		SIZE	POWER (KW)			
<b>Boiling top</b>										
	C-GP910	LPG	19075573	450	330	27,00	-	-	27,00	800x930x290
		NG	19075574							
<b>With oven</b>										
	C-GP911	LPG	19075575	450	330	27,00	665x665x325	7,30	34,30	800x930x850
		NG	19075576							

## Electric cookers



### General characteristics

- Surface tops manufactured in 2 mm thick AISI-304 stainless steel, designed to prevent liquids spilt from the pans from penetrating into the cooker.
- Laser-cut joints, automatic welding and polished.
- Hot plates manufactured with 300 x 300 mm cast iron, with 4 kW of power, hermetically sealed into the stamped surface top.
- Power regulation by 7 position selector.
- Safety thermostat for each plate.
- Interior fan to lower the temperature of the components.
- Stamped surface with rounded corners for easy cleaning.
- High temperature enamelled cast iron flue protector.

- Access to the components from the front.
- Machines with IPX5 grade water protection.

#### OVEN

- Easy to use static GN 2/1 size oven with the controls positioned on the upper panel for better ergonomics.
- Stainless steel cooking chamber, making it easier to clean and providing better hygiene.
- Tray introduced sideways for easier handling.
- Guides at three heights to offer different working options.
- Guides with "U" shape to prevent the trays from tipping.
- Thermostatic temperature control (125 – 310 °C).

- Heating by means of stainless steel shielded heating elements with selector switch to operate the upper and/or lower zone.
- Oven floor manufactured in 6 mm cast iron, guaranteeing better performance and even heat distribution.
- Fibreglass closing seal to improve the oven's thermal efficiency.
- Dismountable oven door to facilitate repair.

#### VOLTAGE:

- 400 V 3+N.
- Ask for other voltages.

	MODEL	CODE	PLATES		OVEN		TOTAL POWER (kW)	DIMENSIONS (mm)	€	
			(mm)	4,0 kW	SIZE	POWER (kW)				
<b>Boiling top</b>										
		C-E920	19075501	300x300	2	-	-	8,00	400x930x290	-
© STOCK		C-E940	19075505	300x300	4	-	-	16,00	800x930x290	-
		C-E960	19075513	300x300	6	-	-	24,00	1.200x930x290	-
<b>With oven</b>										
© STOCK		C-E941	19075509	300x300	4	GN-2/1	6,00	22,00	800x930x850	-
		C-E961	19075514	300x300	6	GN-2/1	6,00	30,00	1.200x930x850	-
		C-E961 OP	19075516	300x300	6	1.000x700x290	12,00	36,00	1.200x930x850	-

OP MODELS: With large oven 1.000 x 700 x 290 mm.

## Electric solid tops



### General characteristics

- Surface tops manufactured in 2 mm thick AISI-304 stainless steel, designed to prevent liquids spilt from the pans from penetrating into the cooker.
- Laser-cut joints, automatic welding and polished.
- "Solid-top" models with four heating elements beneath the 15 mm thick cast steel fry-top, distributed so as to heat the four quadrants of the fry-top independently.
- Power control for each heating element. This allows the user to work with different temperature gradients on the fry-top.- Interior fan to lower the temperature of the components.
- Stamped surface with rounded corners for easy cleaning.
- High temperature enamelled cast iron flue protector.
- Access to the components from the front.

- Machines with IPX5 grade water protection.

#### OVEN

- Easy to use static GN 2/1 size oven with the controls positioned on the upper panel for better ergonomics.
- Stainless steel cooking chamber, making it easier to clean and providing better hygiene.
- Tray introduced sideways for easier handling.
- Guides at three heights to offer different working options.
- Guides with "U" shape to prevent the trays from tipping.

- Thermostatic temperature control (125 – 310 °C).
- Heating by means of stainless steel shielded heating elements with selector switch to operate the upper and/or lower zone.
- Oven floor manufactured in 6 mm cast iron, guaranteeing better performance and even heat distribution.
- Fibreglass closing seal to improve the oven's thermal efficiency.
- Dismountable oven door to facilitate repair.

VOLTAGE: 400 V 3+N . Ask for other voltages.

	MODEL	CODE	FRY-TOP		OVEN		TOTAL POWER (kW)	DIMENSIONS (mm)	€		
			MEASUREMENTS	COOKING AREAS	POWER (kW)	SIZE					
<b>Solid Top</b>											
		C-E910	19075495	720x720	4	4x4	-	-	16,00	800x930x290	-
<b>With oven</b>											
		C-E911	19075498	720x720	4	4x4	GN-2/1	6,00	22,00	800x930x850	-

## Induction cookers



### General characteristics

- 6 mm thick glass ceramic, hermetically sealed into the 2 mm thick AISI-304 stainless steel surface top.
- Laser-cut joints, automatic welding and polished.
- Cooking areas demarcated by Ø 280 mm circular screen print, with 5 kW of power in each area, rapidly heated and ideal for à la carte service.
- Perfect control of cooking thanks to the energy regulator with 10 power levels, which allows you to work at low power for delicate recipes or at maximum power for fast service.
- Supplies energy only to the area upon which the container rests, with the rest of the glass ceramic surface remaining cold.
- Only functions when the presence of a cooking container is detected. Heating is interrupted upon removing the container.
- As a result, a great energy saving is obtained (energy consumption is reduced by around 50 % compared to gas burners).
- The working environment and atmosphere is more comfortable, as the energy is concentrated on the base of the container to be heated, irradiation and heat dispersal are reduced and the cooking temperature is reached rapidly.
- Safety against overheating. Diagnosis of errors (flashing lights).
- High temperature enamelled cast iron flue protector.
- Access to the components from the front.
- Machines with IPX5 grade water protection.
- VOLTAGE: 400 V 3ph-

	MODEL	CODE	PLATES		TOTAL POWER (kW)	DIMENSIONS (mm)	€
			5,0 kW	Ø mm			
<b>Induction panels</b>							
© STOCK	C-I925	19075577	2	280	10,00	400x930x290	-
© STOCK	C-I945	19075578	4	280	20,00	800x930x290	-
<b>Wok</b>							
	W-I905	19075893	1	300	5,00	400x930x290	-

## Pasta cookers



### General characteristics

- Surface tops manufactured in 2 mm thick AISI-304 stainless steel.
- Laser-cut joints, automatic welding and polished.
- Wells integrated into the surface top, manufactured in 1.5 mm thick AISI-316L stainless steel.
- Wells with 1/1 dimensions, capacity 40 litres. Accommodate different configurations of different sized baskets
- Standard configuration : three 1/3 type baskets per well.
- Optional kit basket type 1/4 and type 1/6.
- Medium & high speed well filling using electrovalve positioning.
- Draining of well using of high temperature resistant mechanical ball valve with safety overflow.
- Automatic safety system that breaks the circuit if the water runs out.
- Drainer located at the front for the baskets to be rested on.
- Controls with protective base and system against water infiltration. High temperature enamelled cast iron flue protector.
- Access to the components from the front.
- Machines with IPX5 grade water protection.
- Electric models with AISI-304 stainless steel heating elements situated in the bottom of the well to heat the water directly.
- Heating controls by energy regulator.
- Voltage: 400 V 3+N - Ask for other voltages.
- Optional accessories (see accessories page at end of chapter)
- Kit of 6 baskets 1/6 square.
- Kit of 6 baskets 1/6 round.
- Kit of 2 baskets 1/2.

### GAS MODELS

- Gas models with stainless steel burner situated on the outside of the well with combustion chamber that allows the well to be heated from the bottom and sides (up to the minimum filling level).
- Electronic ignition by spark train. Alternative manual ignition tube.
- Heating controlled by safety valve.

	MODEL	GAS	CODE	WELL			TOTAL POWER (kW)	DIMENSIONS (mm)	€
				QUANTITY	SIZE	BASKETS (1/3)			
<b>Gas pasta cookers</b>									
© STOCK	CP-G905	LPG	19075585	1	GN-1/1	3	16,00	400x930x850	-
© STOCK		NG	19075587						
	CP-G910	LPG	19075589	2	GN-1/1	6	32,00	800x930x850	-
		NG	19075590						
<b>Electric pasta cookers</b>									
© STOCK	CP-E905	-	19075581	1	GN-1/1	3	12,00	400x930x850	-
	CP-E910	-	19075584	2	GN-1/1	6	24,00	800x930x850	-



# Fry-tops



## General characteristics

- Surface tops manufactured in 2 mm thick AISI-304 stainless steel.
- Laser-cut joints, automatic welding and polished.
- Fry-tops manufactured in 20 mm thick mild steel, high powered and with rapid temperature attainment.
- Versions with 50 micron thick chrome surface for the three types of fry-top.
- Models with smooth, grooved and mixed (2/3 smooth and 1/3 grooved) fry-tops.
- Electrical heated models use stainless steel shielded heating elements, temperature controlled by thermostat, between 100 and 300 °C.
- Gas heated models have burners with two branches (one burner for half module models, two independent burners for models with a whole module).

- Gas models come with the option of thermostatic temperature control (between 100 and 300 °C) or with operation by security valve with thermocouple.
- Gas: Ignition by electronic spark train. Easy manual ignition.
- The whole module fry-tops come with independent heating zones.
- Safety thermostat in models with thermostatic control.
- Rapid reaction and recovery times of the fry-top temperature.
- The fry-tops are integrated into the stamped surface top.
- The stamped housing with rounded edges and corners make them very easy to clean.
- Fry-top tilted towards the front to facilitate fat and liquid collection.

- Fitted with an opening for the collection of cooking fat and storage tray with a capacity of up to 2 litres depending on the model.
- Option of easily dismountable side and back splash guards.
- High temperature enamelled cast iron flue protector.
- Access to the components from the front.
- Machines with IPX5 grade water protection.

OPTIONAL ACCESSORIES  
(see accessories page at end of chapter)

- Scraper (\*).
- Splash guard (in three pieces to facilitate cleaning).

VOLTAGE FOR ELECTRIC MODELS:

- 400 V 3+N - Ask for other voltages.



(\*). Models with chrome surface, scraper included

	MODEL	GAS	CODE	PLATE			TOTAL POWER (kW)	DIMENSIONS (mm)	€	
				TYPE (*)	AREAS	(mm) dm <sup>2</sup>				
<b>GAS-FRY-TOPS</b>										
<b>Max-min valve</b>										
	FT-G905 V L	LPG	19101457	L	1	335x640	21,50	9,25	400x930x290	-
		NG	19101458							
	FT-G905 V R	LPG	19101459	R	1	335x640	21,50	9,25	400x930x290	-
		NG	19101460							
STOCK	FT-G910 V L	LPG	19101485	L	2	735x640	47,00	18,50	800x930x290	-
		NG	19101486							
	FT-G910 V R	LPG	19101489	R	2	735x640	47,00	18,50	800x930x290	-
		NG	19101490							
	FT-G910 V LR	LPG	19101487	L+R	2	735x640	47,00	18,50	800x930x290	-
		NG	19101488							
<b>CONTROL BY THERMOSTAT</b>										
	FT-G905 L	LPG	19101449	L	1	335x640	21,50	9,25	400x930x290	-
		NG	19101451							
	FT-G905 R	LPG	19101453	R	1	335x640	21,50	9,25	400x930x290	-
		NG	19101455							
STOCK	FT-G910 L	LPG	19101473	L	2	735x640	47,00	18,50	800x930x290	-
STOCK		NG	19101475							
	FT-G910 R	LPG	19101481	R	2	735x640	47,00	18,50	800x930x290	-
		NG	19101483							
	FT-G910 LR	LPG	19101477	L+R	2	735x640	47,00	18,50	800x930x290	-
		NG	19101479							
<b>CONTROL BY THERMOSTAT AND CHROMIUM HOT-PLATE</b>										
STOCK	FT-G905 C L	LPG	19101134	L / C	1	335x640	21,50	9,25	400x930x290	-
		NG	19101136							
	FT-G905 C R	LPG	19101144	R / C	1	335x640	21,50	9,25	400x930x290	-
		NG	19101146							
STOCK	FT-G910 C L	LPG	19101461	L / C	2	735x640	47,00	18,50	800x930x290	-
STOCK		NG	19101463							
	FT-G910 C R	LPG	19101469	R / C	2	735x640	47,00	18,50	800x930x290	-
		NG	19101471							
	FT-G910 C LR	LPG	19101465	L+R / C	2	735x640	47,00	18,50	800x930x290	-
		NG	19101467							
<b>Electric - fry-tops</b>										
<b>CONTROL BY THERMOSTAT</b>										
STOCK	FT-E905 L	-	19101427	L	1	335x640	21,50	7,50	400x930x290	-
	FT-E905 R	-	19101430	R	1	335x640	21,50	7,50	400x930x290	-
STOCK	FT-E910 L	-	19101442	L	2	735x640	47,00	15,00	800x930x290	-
	FT-E910 R	-	19101448	R	2	735x640	47,00	15,00	800x930x290	-
	FT-E910 LR	-	19101445	L+R	2	735x640	47,00	15,00	800x930x290	-
<b>Control by thermostat and chromium hot-plate</b>										
	FT-E905 C L	-	19101131	L / C	1	335x640	21,50	7,50	400x930x290	-
	FT-E905 C R	-	19101141	R / C	1	335x640	21,50	7,50	400x930x290	-
	FT-E910 C L	-	19101433	L / C	2	735x640	47,00	15,00	800x930x290	-
	FT-E910 C R	-	19101439	R / C	2	735x640	47,00	15,00	800x930x290	-
	FT-E910 C LR	-	19101436	L+R / C	2	735x640	47,00	15,00	800x930x290	-

(\*) TYPE OF PLATE:  
L: Smooth hot-plate  
R: ribbed hot-plate  
L+R: 2/3 smooth and 1/3 ribbed hot-plate  
C: chrome surface

# Fryers

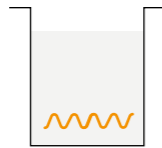

- High-power machines which heat up very fast and with a high power:litre ratio (up to 1.00 kW/litre in gas models).
- Ignition by spark train for the gas models.
- Safety thermostat in all models.
- Unloading of oil from the well by means of a robust and reliable ball valve, resistant to high temperatures.
- With individual lids for each well.
- High temperature enamelled cast iron flue protector.
- Access to the components from the front.
- Machines with IPX5 grade water protection.

#### MODEL WITH DIGITAL CONTROL:

- High-precision electronic oil temperature control between 60-200°C, +/- 1°C.
- Setpoint temperature display with an indicator to show when temperature has been reached.
- Time control card per basket with audible alarm.
- "Melting" programme.

#### SUPPLIED BASKETS

- 21-litre fryers: 2 small bas-kets per well (130 x 330 x 130 mm).
- 15-litre fryers: 1 small basket per well (250 x 280 x 100 mm).

#### Optional accesso-ries

- (see accessories page at the end of the chapter)
- 21-litre fryers: large basket (260 x 330 x 130 mm).
  - 15-litre fryers: small basket (125 x 280 x 100 mm).

## General characteristics

- Surface tops manufactured in 2 mm thick AISI-304 stainless steel.
- Laser-cut joints, automatic welding and polished.
- Wells stamped into the surface top.
- Cold zone in the lower part of the well, which helps to maintain the quality and characteristics of the oil in use for longer.
- Thermostatic temperature control between 60 and 200 °C.
- Gas models with three longitudinal heating tubes integrated into the well.
- High efficiency gas burners.
- Electric models with AISI-304 stainless steel heating elements located inside the well, which can be swivelled by more than 90° for perfect cleaning.

MODEL	CODE		HZ.	TANKS			TOTAL POWER (kW)	DIMENSIONS (mm)	€
	LPG	NG		QUANTITY	VOLUME (l)	BASKETS			
<b>Gas Fryers*</b>									
F-G9115	19078845	19081732	50	1	1x15	1 large	15,00	400x930x850	-
F-G9215	19081735	19081738	50	2	2x15	2 large	30,00	800x930x850	-
F-G9121	19075613	19075616	50	1	1x21	2 small	21,00	400x930x850	-
F-G9221	19075625	19075628	50	2	2x21	4 small	42,00	800x930x850	-
<b>Electric fryers</b>									
F-E9115	19078867	400V 3N	50/60	1	1x15	1 large	12,00	400x930x850	-
F-E9215	19081692	400V 3N	50/60	2	2x15	2 large	24,00	800x930x850	-
F-E9121	19075600	400V 3N	50/60	1	1x21	2 small	18,00	400x930x850	-
F-E9221	19075606	400V 3N	50/60	2	2x21	4 small	36,00	800x930x850	-
<b>Electric fryers with digital control</b>									
F-E9121 D	19075900	400V 3N	50/60	1	1x21	2 small	29,00	400x930x850	-

(\*): Check availability on other frequencies.

# Fryers

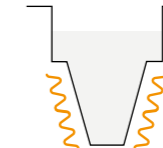

## General characteristics

- Surface tops manufactured in 2 mm thick AISI-304 stainless steel.
- Laser-cut joints, automatic welding and polishes. Screws hidden from view.
- Cold zone in the lower part of the tank, which helps to maintain the quality and characteristics of the oil in use for longer.
- Safety thermostat in all models.
- Unloading of oil from the tank by means of a robust and reliable ball valve, resistant to high temperatures.
- Individual lid.
- High temperature enamelled cast iron flue protector.
- Access to the components from the front.
- Machines with IPX5 grade water protection.

- Easy to clean V-shaped tank into the surface top with robotized weld and polished.
- External high efficiency heating elements.
- Container placed under the tank for oil drains with filter.
- Thermostatic temperature control between 60 and 200 °C.
- High-power machines which heat up very fast and with a high power: litre ratio (up to 1.00 kW/litre in gas models).
- Ignition by spark train for the gas models.

MODEL	CODE		Hz.	TANKS			TOTAL POWER (kW)	DIMENSIONS (mm)	€
	LPG	NG		QUANTITY	VOLUME (l)	BASKETS			
<b>Gas Fryers*</b>									
F-G9123	19099107	19099109	50	1	1x23	2 small	23,00	400x930x850	-
<b>Electric fryers</b>									
F-E9123	19097622	400V 3N	50/60	1	1x23	2 small	23,00	400x930x850	-

(\*): Check availability on other frequencies.



# Grill



## General characteristics

- Surface tops manufactured in 2 mm thick AISI-304 stainless steel.
- Laser-cut joints, automatic welding and polished.
- Cast iron grills, dismountable without the need for tools, in 170 mm wide sections.
- The iron grills are reversible, with different finishes on each side:
  - Tilted and grooved with ridges for meat.
  - Horizontal and flat for fish and vegetables.
- The grills reach a very high temperature (400 °C), meaning that the surface of the product seals rapidly, keeping the inside of the food much juicier.
- In the models with stainless steel grill, this is manufactured with sheets of AISI-304 in "V" shape to facilitate cleaning.
- Fitted with an opening for the collection of cooking fat and storage tray with a capacity of up to 12 litres (one tray in half module machines, two trays in machines with a whole module).
- The fat collection trays offers the option of putting water in them, and thanks to the heat irradiation of the gas burners or electrical heating elements, low intensity steam is generated, so that the food can be grilled in an atmosphere of steam.
- Grills fitted with 130 mm high dismountable guard to avoid splashing, manufactured in stainless steel.

- High temperature enamelled cast iron flue protector.
- Access to the components from the front.
- Machines with IPX5 grade water protection.

### ELECTRIC COUNTERTOP MODELS

- Groups of stainless steel covered elements upon which you can cook food directly (a group of 3 elements for half-sized module models and 2 groups for whole module models).
- Water tray for safety. It also allows an adequate level of humidity to be reached for optimum cooking conditions.

### ELECTRIC FLOOR MODELS

- Groups of three stainless steel elements under the roasting rack, with radiant deflector (a group of three elements for half-sized module models, two groups for whole module models).
- Independent control for each group of elements via an energy regulator.

### GAS COUNTERTOP MODELS

- Groups of high-efficiency tube burners, (a group of two burners for half-sized module models, two groups for a single module models).
- Independent control for each group of burners via a safety valve with a thermocouple.
- Burners turned on using Piezo electric ignition.

- The burners heat ceramic stones that sit on a supporting rack, so that they can then heat food on the grill.

### GAS FLOOR MODELS

- Groups of three high-efficiency tube burners, with a radiant deflector (a group of three burners for half-sized module models, two groups for whole module models).
- Independent control for each group of burners via a safety valve with a thermocouple.
- Burners are turned using an electric multi-spark ignition. With an access tube for manual ignition.

Accessories included (See accessories page at the end of the chapter)



Special scraper with two profiles for models with cast iron grill.



Special scraper adapted for models with stainless steel grill.

MODEL	GAS	CODE	GRIDS				TOTAL POWER (kW)	DIMENSIONS (mm)	€	
			TYPE	AREAS	QUANTITY	(mm) (dm²)				
<b>GAS GRILL</b>										
<b>Countertop</b>										
B-G905 I	LPG	19078584	Inox	1	1	340x690	24	11	400x930x290	-
	NG	19081684								
B-G905	LPG	19078902	Mild steel	1	2	340x690	24	11	400x930x290	-
	NG	19081682								
B-G910 I	LPG	19078582	Inox	2	2	680x690	48	22	800x930x290	-
	NG	19081686								
B-G910	LPG	19078901	Mild steel	2	4	680x690	48	22	800x930x290	-
	NG	19081685								
B-G915 I	LPG	19081680	Inox	3	3	1020x690	72	33	1200x930x290	-
	NG	19081681								
B-G915	LPG	19079204	Mild steel	3	6	1020x690	72	33	1200x930x290	-
	NG	19081639								
<b>Floor</b>										
B-G9051 I	LPG	19075474	Inox	1	1	340x690	24	11	400x930x850	-
	NG	19075475								
B-G9051	LPG	19075476	Mild steel	1	2	340x690	24	11	400x930x850	-
	NG	19075478								
B-G9101 I	LPG	19075480	Inox	2	2	680x690	48	22	800x930x850	-
	NG	19075481								
B-G9101	LPG	19075482	Mild steel	2	4	680x690	48	22	800x930x850	-
	NG	19075484								
<b>ELECTRIC GRILL</b>										
<b>Countertop</b>										
B-E905	-	19078931	Inox	1	1	255x640	16	5,42	400x930x290	-
B-E910	-	19078922	Inox	2	1	545x640	35	10,84	800x930x290	-
<b>Floor</b>										
B-E9051 I	-	19075417	Inox	1	1	340x690	24	7,5	400x930x850	-
B-E9051	-	19075413	Mild steel	1	2	340x690	24	7,5	400x930x850	-
B-E9101 I	-	19075473	Inox	2	2	680x690	48	15	800x930x850	-
B-E9101	-	19075470	Mild steel	2	4	680x690	48	15	800x930x850	-

# Boiling pans



## General characteristics

- Surface tops manufactured in 2 mm thick AISI-304 stainless steel.
- Laser-cut joints, automatic welding and polished.
- Double walled lid balanced by means of a hinge with front handle, with diagonal opening to 75° which allows the lid to be kept open in any position.
- Well stamped into the surface top by robotic welding, manufactured in AISI-304 stainless steel, with the bottom of the well in AISI-316L stainless steel.
- Well filling with hot or cold water by electrovalve, activated with a single switch located on the front panel as previous page.
- Well emptying by 2" safety valve with handle in athermic material and safe and effortless handling.
- Robust and reliable filter for draining the well manufactured in AISI-304 stainless steel. Easily extractable.
- Controls with protective base and system against water infiltration.
- High temperature enamelled cast iron flue protector.
- Access to the components from the front.
- Machines with IPX5 grade water protection.

### Indirectly heated models – bain marie

- Bain marie chamber around the well, with automatic filling system when the machine is connected.
- Automatic chamber level control with quadruple security: pressure switch, overpressure security valve, thermostat to limit overheating in the chamber and pressure gauge incorporated into the surface top.
- Automatic flushing of the chamber.
- Heating at the bottom of the pan acts on the water in the surrounding chamber, meaning that the saturated steam generated at a temperature of 107 °C heats the bottom and sides of the well in a uniform manner.
- The temperature reached is lower than that obtained with direct heating.
- Stamped pan floor to avoid deformations.
- Indicator light to show when the machine is connected and when it is heating.

### GAS MODELS

- Group of optimised combustion stainless steel tubular burners, controlled by energy regulator and by pressure switch.
- Control by energy regulator and by pressure switch, permitting lower water and energy consumption.
- Ignition of group of burners by spark train.

### ELECTRIC MODELS

- Heating elements located in the lower part of the bain marie.
- Heating controlled by energy regulator and pressure switch.
- Voltage: 400 V 3+N - Ask for other voltages.

### PRESSURE OPERATION

- Folding and compensated lid, with flange closure
- Operation with pressure in the cooking well, 0.3 atmospheres.
- Overpressure safety valve on the lid.

MODEL	Hz.	CODE		TANK		TOTAL POWER (kW)	DIMENSIONS (mm)	€
		LPG	NG	Ø X H (mm)	VOLUME (l)			
<b>GAS BOILING PANS*</b>								
<b>Direct fire</b>								
 M-G910	50	19075824	19075826	600x400	100	20,00	800x930x850	-
 M-G915	50	19075832	19075834	600x550	150	24,00	800x930x850	-
 M-G920	50	19075836	19075838	600x650	200	24,00	800x930x850	-
<b>Indirect flame</b>								
 M-G910 BM	50	19075819	19075822	600x400	100	20,00	800x930x850	-
 M-G915 BM	50	19075828	19075830	600x550	150	24,00	800x930x850	-
<b>Pressure</b>								
 MP-G910	50	19075840	19075842	600x400	100	20,00	800x930x850	-
 MP-G915	50	19075845	19075846	600x550	150	24,00	800x930x850	-
 MP-G920	50	19075848	19075850	600x650	200	24,00	800x930x850	-
<b>ELECTRIC BOILING PANS</b>								
<b>Indirect flame</b>								
 M-E910 BM	-	19075814		600x400	100	22,00	800x930x850	-
 M-E915 BM	-	19075817		600x550	150	22,00	800x930x850	-

(\*) Check availability on other frequencies.

# Tilting bratt pans



- Pans filled with water by means of electric valve operated with switch on the front of the machine. The filling pipe is located at the back of the machine.
- Double walled lid with drainer at the back to redirect water of condensation back into the well.
- Lid balance system by springs. Compensation system to avoid heavy falls. Can be regulated, with the same system for all modules.
- Micro breaking switch halts heating when the pan is raised.
- High temperature enamelled cast iron flue protector.
- Access to the components from the front.
- Machines with IPX5 grade water protection.
- Front access lid handle.
- Electrically heated models use shielded stainless steel heating elements located under the bottom of the pan.
- Gas heated models use steel burners with six branches (eight in the pan with one and a half modules), operated and controlled by safety valve with thermocouple.
- Temperature of the bottom of the pan controlled by thermostat, between 50 and 310 °C.
- The heating by branched burners or electrical heating elements located in the base of the pan itself, together with the high thickness of the bottom of the pan, ensure maximum uniformity of temperature distribution in all cases, guaranteeing even cooking.

VOLTAGE FOR ELECTRIC MODELS:  
- 400 V 3+N - Ask for other voltages.

## General characteristics

- Laser-cut joints, automatic welding and polished.
- Motorised or crank operated elevation systems which raises the pan until it is vertical, to empty it completely.
- Versions with cast iron and stainless steel pans.
- Pan design with a rounded corners and no edges, and with a wide opening for unloading, making all cooking and cleaning operations easier.
- Flange around the perimeter to stop any condensed water from spilling over.
- The bottom of the wells is very thick (8 mm for iron pans and 10 mm for stainless steel pans), guaranteeing even heat distribution.

MODEL	HZ.	CODE		RAISING SYSTEM	TANK TYPE (*)	CAPACITY (l)	SURFACE		TOTAL POWER (kW)	DIMENSIONS (mm)	€
		LPG	GN				(mm)	(dm <sup>2</sup> )			
<b>GAS TILTING BRATT PANS*</b>											
SB-G910 I	50	19075867	19075876	Manual	Stainless steel	90	730x616	45	18,00	800x930x850	-
SB-G910	50	19075879	19075885	Manual	Cast Iron	90	730x616	45	18,00	800x930x850	-
SB-G910 IM	50	19075870	19075873	Motorized	Stainless steel	90	730x616	45	18,00	800x930x850	-
SB-G910 M	50	19075881	19075883	Motorized	Cast Iron	90	730x616	45	18,00	800x930x850	-
SB-G915 IM	50	19075887	19075890	Motorized	Stainless steel	120	1.130x616	70	25,00	1.200x930x850	-
<b>ELECTRIC TILTING BRATT PANS</b>											
SB-E910 I		19075857		Manual	Stainless steel	90	730x616	45	15,00	800x930x850	-
SB-E910		19075854		Manual	Cast Iron	90	730x616	45	15,00	800x930x850	-
SB-E910 IM		19075860		Motorized	Stainless steel	90	730x616	45	15,00	800x930x850	-
SB-E910 M		19075863		Motorized	Cast Iron	90	730x616	45	15,00	800x930x850	-
SB-E915 IM		19075866		Motorized	Stainless steel	120	1.130x616	70	22,50	1.200x930x850	-

(\*): Check availability on other frequencies.

# Bain maries



## General characteristics

- Surface tops manufactured in 2 mm thick AISI-304 stainless steel.
- Laser-cut joints, automatic welding and polished.
- Wells accommodating different configurations of Gastronorm containers of different sizes, 150 mm high and with dimensions:
- Half module: GN-1/1+1/3, with 22 litres capacity.
- One module: GN-2/1+(2x1/3), with 44 litres capacity.
- Wells stamped into the surface top, manufactured with AISI-304 stainless steel.
- Standard format: 3 crosspieces to support Gastronorm containers.
- Simple draining of the well by removing the

- overflow tube.
- The filling tap is sold as an optional accessory.
- Regulation of water temperature by thermostat, between 30 and 90 °C.
- Controls with protective base and system against water infiltration (IPX5 grade protection).
- High temperature enamelled cast iron flue protector.
- Access to the components from the front.
- Machines with IPX5 grade water protection.
- GAS MODELS
- Insulated combustion chamber, reducing heating of components.
- High efficiency stainless steel burner, located on the outside of the well.
- Electronic ignition by spark train.

- Tube for alternative manual ignition.
- ELECTRIC MODELS
- AISI-304 stainless steel heating elements located on the outside of the well.
- Safety thermostat in the electric models
- Voltage: 400 V 3+N. It can be transformed to other voltages..
- OPTIONAL ACCESSORIES
- (see accessories page at end of chapter)
- Simple tap to install at the back of the bain marie.

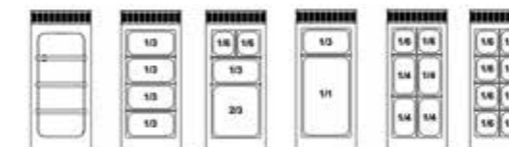

BM 905 POSSIBLE HUB COMBINATIONS

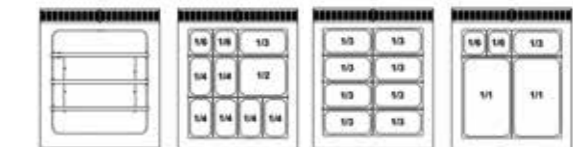

BM 910 POSSIBLE TANK COMBINATIONS

MODEL	GAS	CODE	TANK SIZE	VOLUME (l)	TOTAL POWER (kW)	DIMENSIONS (mm)	€
BM-G905	LPG NG	19075491 19075492	GN-4/3	22	3,25	400x930x290	-
BM-G910	LPG NG	19075493 19075494	GN-8/3	44	6,50	800x930x290	-
<b>ELECTRIC BAIN MARIE</b>							
BM-E905	-	19075487	GN-4/3	22	3,00	400x930x290	-
BM-E910	-	19075490	GN-8/3	44	6,00	800x930x290	-

## Chips scuttle



### General characteristics

- Half module electrical heating machine, heated by infrared light.
- Surface tops manufactured in 2 mm thick AISI-304 stainless steel.
- Laser-cut joints, automatic welding and polished.
- Pan stamped into surface top, with capacity for 150 mm high Gastronorm GN-1/1 container.
- Perforated double bottom manufactured in stainless steel, tilted to remove excess frying oil and collected it in the container.
- Heat maintained by infrared lamp located at the back of the machine, operated by ON/OFF switch.
- Control with system against water infiltration.
- High temperature enamelled cast iron flue protector.
- Access to the components from the front.
- Machines with IPX5 grade water protection.





MODEL	CODE	WELLS	POWER (kW)	DIMENSIONS (mm)	€
 MF-E905	19075818	GN-1/1	1,00	400x930x290	-

## Neutral elements



### General characteristics

- Half module and one module appliances.
- Surface tops manufactured in 2 mm thick AISI-304 stainless steel.
- Laser-cut joints, automatic welding and polished.
- Machines adapted for the connection of a filling tap or water column at the back.
- High temperature enamelled cast iron back flue trim.

MODEL	CODE	DRAWERS		DIMENSIONS (mm)	€
		QUANTITY	(mm)		
 EN-9025*	19048351	-	-	200x930x290	-
 EN-905	19075591	-	-	400x930x290	-
 EN-910	19075593	-	-	800x930x290	-
 EN-905 C	19075592	1	300x590x105 (valid GN-1/1)	400x930x290	-
 EN-910 C	19075594	1	700x590x105	800x930x290	-

\* It can only be in central blocks or murals without verticality.

# Stands



## General characteristics

- Manufactured with a solid structure in AISI-304 stainless steel.
- Easy connection to support 900 Kore range equipment.
- Can be used as open storage.
- Designed for the attachment of doors to turn them into closed cupboards.

	MODEL	CODE	DOORS IN OPTION (NOT INCLUDED)	DRAWERS	GUIDES (5 LEVELS)	DIMENSIONS (mm)	€
	MB-9025	19048470	-	-	-	200x850x600	-
	MB-905	19018700	1	-	-	400x850x600	-
	MB-905 C	19084564	-	2	-	400x850x600	-
	MB-905 G	19086897	1	-	1	400x850x600	-
	MB-910	19022189	2	-	-	800x850x600	-
	MB-915	19020374	3	-	-	1.200x850x600	-

## Doors for stands

The kit allows the door to be reversible, so that it can be assembled opening to the left or to the right. The number of doors depends on the stand to which they are to be mounted:

	MODEL	CODE	DESCRIPTION	€
	DOOR KIT	19040900	The kit allows the door to be reversible, so that it can be assembled to open to the left or to the right. The number of doors depends on the stand to which they are to be mounted.	-

# Refrigerated stands



## General characteristics

- Structure built in AISI-304.
- Sealed compressor with ventilated condenser.
- Copper pipe evaporator with aluminum wings.
- 50 mm injected polyurethane insulation with a density of 40kg/m<sup>3</sup>.
- BP models with panoramic door opening and automatic closing device with stay open feature above 90°.
- Height adjustable stainless-steel legs (from 130mm to 190mm) allows adjusting the overall height of the counter from 580 to 640mm.
- Forced air refrigeration system
- Working temperature: -2 °C, +8 °C, at room temperature of 38 °C.
- Tested in climate class 4.
- Electronic temperature and defrosting control and display.
- W model with GN 1/1 holding capacity drawers.
- W2 model with a full-length flat drawer with GN2/1 holding capacity and equipped with 5 crosspieces to support different combinations of GN containers.
- Stainless steel back panel.
- Options:
  - Kit of 6 castors (2 with brakes). Factory fitted.
  - 60Hz

MODEL	COOLANT	Hz.	CODE	N. DOORS AND DRAWERS	ENERGY EFFICIENCY CLASS	GROSS CAPACITY (L)	ANNUAL ENERGY CONSUMPTION (kw-h)	ELECTRIC POWER(W)	DIMENSIONS (MM)	€
<b>Models with doors</b>										
CCP9-2G	R290	50	19089615	2	B	169	714	250	1.200x900x590	-
<b>Models with 2/3 drawers</b>										
CCP9-2G W	R290	50	19089616	2 x 2/3	B	169	714	250	1.200x900x590	-
<b>Models with full length flat drawers</b>										
CCP9-2G W2	R290	50	19089617	2 x GN 2/1	C	169	777	262	1.200x900x590	-
<b>Models with doors</b>										
CCP9-3G	R290	50	19089618	3	D	240	1113	249	1.600x900x590	-
<b>Models with 2/3 drawers</b>										
CCP9-3G W	R290	50	19089619	3 x GN 1/1	D	240	1113	249	1.600x900x590	-



# Configuration and finishes

## KORE Modular 900

Configurable blocks KORE 900



BLOCK TYPE	CONFIGURATION		ASSEMBLY KITS			VERTICALITY			SIDE FINISHES		PLINTH	
	WALL	CENTRAL	ADDITIONAL STRUCTURE	"STANDARD SUPPORTS"	SUPPORTS FOR MACHINERY	RACKS	SIDE TRIM	FLAT PANEL	STANDARD	SPECIAL		
KITCHEN		KORE										
	KORE	KORE										
<b>GROUND</b>												
	900	900/900 900/700	-	o	o	o	o	o	o	o		
<b>BRIDGE</b>												
	900	900/900 900/700	x	o	o	o	o	o	o	o		
<b>SUSPENDED</b>												
	900	900/900 900/700	x	o	o	o	*	o	-	o		

- : Does not need
- x: Mandatory
- o: Optional
- : Serial
- \*: Consult

# Assembly kits

## Bridge block kit

Structure to assemble a BRIDGE block



CONFIGURATION		BLOCK LENGTH	CODE	€
CENTRAL	WALL	MODULES	REF.	
		1M	19044954	-
		1.5M	19044955	-
KORE		2M	19044956	-
KORE	KORE	2.5M	19044957	-
		3M	19044958	-
		3.5M	19044959	-
		4M	19044960	-

\* Order 1 unit for each side of the bridge, i.e. 2 units in case of central block and 1 unit for murals.

## Suspended kit

Structure for mounting a SUSPENDED block



CONFIGURATION		BLOCK LENGTH	CODE	€		
BLOCK TYPE		MODULES	REF.			
Wall	KORE	2M	19044934	-		
		2.5M	19044935	-		
		3M	19044936	-		
		3.5M	19044937	-		
		4M	19044938	-		
		4.5M	19044939	-		
		5M	19044940	-		
		5.5M	19044941	-		
		6M	19044942	-		
		Central	KORE KORE	2M	19044945	-
				2.5M	19044946	-
				3M	19044947	-
3.5M	19044948			-		
4M	19044949			-		
4.5M	19044950			-		
		5M	19044951	-		
		5.5M	19044952	-		
		6M	19044953	-		

\*The kit includes side termination with smooth paneling



# Verticality

## Supports

Supports for verticality in GROUND, BRIDGE and SUSPENDED blocks



SUPPORTS	CONFIGURATION	CODE	€
<b>Type</b>	<b>With or without additional elements</b>	<b>Ref.</b>	
<b>Standard</b> 100x100mm profile	Standard (no added items)	19095368	-
	Standard with tap (included in profile)	19095390	-
	Standard with 220V plug (included in profile)	19095369	-
<b>Special</b> for machinery	For iKORE 0623 oven	19095391	-
	For salamander	19095392	-

Notes:

\* Select a combination of 2 supports. Total = 2 units/codes, even if they are repeated.

\* Not suitable for suspended wall blocks.

\* Must be placed on neutral parts measuring 1M on both sides.

## Racks

Racks for verticality in GROUND, BRIDGE and SUSPENDED blocks

BLOCK LENGTH	WALL KORE BLOCK		CENTRAL KORE/KORE BLOCK					
	2 X STANDARD SUPPORTS		2 X STANDARD SUPPORTS		1 X STANDARD SUPPORT + 1 X SPECIAL SUPPORT		2 X SPECIAL SUPPORTS	
MODULES	CODE	€	CODE	€	CODE	€	CODE	€
2M	19096849	-	19096559	-	-	-	-	-
2.25M	19096849	-	19096559	-	-	-	-	-
2.5M	19096852	-	19096116	-	19104184	-	-	-
2.75M	19096852	-	19096116	-	19104184	-	-	-
3M	19096853	-	19096349	-	19104185	-	19104186	-
3.25M	19096853	-	19096349	-	19104185	-	19104186	-
3.5M	19096854	-	19096532	-	19104187	-	19104188	-
3.75M	19096854	-	19096532	-	19104187	-	19104188	-
4M	19096855	-	19096535	-	19104189	-	19104190	-
4.25M	19096855	-	19096535	-	19104189	-	19104190	-
4.5	19096856	-	19096525	-	19104191	-	19104192	-
4.75M	19096856	-	19096525	-	19104191	-	19104192	-
5M	19096858	-	19096526	-	19104193	-	19104194	-

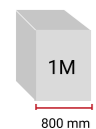

\* 1M = 1 module = 800mm

# Plinths

## Modular plinths 900

Plinths for GROUND and BRIDGE blocks



PLINTH FINISH	BLOCK LENGTH MODULES	WORKTOP HEIGHT		CODES		€
		850	900	ELECTRIC	GAS*	
0.5M	x	x		19081991	19081990	-
			x	19100199	19100454	-
0.75M	x	x		19087898	19087869	-
			x	19100200	19100455	-
1M	x	x		19081809	19081800	-
			x	19100201	19100456	-
1.25M	x	x		19087897	19087868	-
			x	19100202	19100457	-
1.5M	x	x		19081808	19081789	-
			x	19100203	19100458	-
1.75M	x	x		19087896	19087867	-
			x	19100204	19100459	-
2M	x	x		19081807	19081788	-
			x	19100205	19100470	-
2.25M	x	x		19087895	19087866	-
			x	19100433	19100471	-
2.5M	x	x		19081806	19081787	-
			x	19100434	19100472	-
2.75M	x	x		19087894	19087865	-
			x	19100435	19100473	-
3M	x	x		19081805	19081786	-
			x	19100436	19100474	-
3.25M	x	x		19087893	19087706	-
			x	19100437	19100475	-
3.5M	x	x		19081804	19081785	-
			x	19100438	19100476	-
3.75M	x	x		19087892	19087864	-
			x	19100478	19100477	-
4M	x	x		19081803	19081784	-
			x	19100479	19100490	-
4.25M	x	x		19087891	19087863	-
			x	19100491	19100492	-
4.5M	x	x		19081802	19081783	-
			x	19100494	19100495	-
4.75M	x	x		19087890	19087862	-
			x	19100497	19100498	-
5M	x	x		19081801	19081782	-
			x	19100499	19100500	-

\* If the block consists of a gas machine, select the code shown in the gas column.

\* 1M = 1 módulo = 800mm



## Special plinth for V-shaped fryer

Divided plinth for V-shaped fryer

PLINTH FINISH	MODEL V-SHAPED FRYER	WORKTOP HEIGHT		CODES REF.	€
		850	900		
	F-(E/G)9123	x		19107373	-
			x	19107374	-

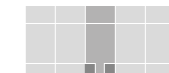

# Side finishes

## Side finish for 900 modular blocks

Side ends for GROUND and BRIDGE blocks



FINISH	CONFIGURATION	VERTICALITY		WORKTOP HEIGHT		SIDE		CODE	€	
		YES	NO	850	900	SIDE A	SIDE B			
SIDE TRIM	WALL OR CENTRAL BLOCK							REF.		
Side trim ergonomic/aesthetical (+90mm each side)	Top view: A KORE 900 B Wall		x	x			x	19098884	-	
			x	x				x	19098685	-
			x		x		x		19098935	-
			x		x			x	19098913	-
			x	x			x		19098883	-
			x	x				x	19098684	-
	A KORE 900 A Central		x		x		x		19098934	-
			x		x			x	19098912	-
			x	x			x		19098703	-
			x	x			x		19098931	-
			x		x		x		19098037	-
			x		x		x		19098930	-
	A KORE 900 B Central		x	x			x		19098874	-
			x	x				x	19098817	-
			x		x		x		19098908	-
			x		x			x	19098907	-
			x		x		x		19098203	-
			x		x			x	19098686	-
Top view: A KORE 900 B Wall		x		x		x		19098910	-	
		x		x			x	19098909	-	
		x	x			x		19100019	-	
		x	x				x	19100013	-	
		x		x		x		19100030	-	
		x		x			x	19100018	-	
Flat end smooth panel (+2mm per side)	A KORE 900 A Central		x	x		x		19099899	-	
			x	x			x	19099898	-	
	A KORE 900 B Central		x		x		x		19099913	-
			x		x			x	19099911	-
		x	x			x		19106558	-	
		x	x			x		19106559	-	
A KORE 900 B Central		x		x		x		19106601	-	
		x		x			x	19106557	-	
		x	x			x		19106946	-	
		x	x				x	19106949	-	
		x		x		x		19106990	-	
		x		x			x	19106991	-	
A KORE 900 B Central		x	x			x		19106992	-	
		x		x			x	19106993	-	
		x		x		x		19106994	-	
		x		x			x	19106995	-	

## Side finish for suspended blocks

Side ends for SUSPENDED blocks



\* Side finishes are included in the SUSPENDED assembly kits

## Inner finishes for bridge blocks

Side ends for BRIDGE block interiors



CONFIGURATION	WORKTOP HEIGHT		CODE	€
	850	900		
BRIDGE BLOCKS			REF.	
	x		19107487	-
		x	19107488	-

\*Unitary units per side. Select as many as needed.





## Special side finishes for tilting bratt pans

Side ends for blocks with a tilting pan at their ends

FINISHING	CONFIGURATION	VERTICALITY		WORKTOP HEIGHT		SIDE		CODE	€	
		SI	NO	850	900	IZDA (L)	DCHA (R)			
TYPE OF FINISHING	CENTRAL OR WALL CENTRAL							REF.		
Flat panel Smooth finish (+2mm per side)	KORE 900 Wall		x	x			x	19081819	-	
			x	x				x	19081820	-
			x		x		x		19100194	-
			x		x			x	19100148	-
			x	x			x		19100123	-
			x		x			x	19100121	-
	KORE 900 Central		x		x		x		19100124	-
			x		x			x	19100122	-
			x	x			x		19081819	-
			x	x				x	19081820	-
			x		x		x		19100194	-
			x		x			x	19100148	-
	KORE 900 Central		x	x			x		19100130	-
			x		x			x	19100108	-
			x		x		x		19100131	-
			x		x			x	19100109	-
			x		x			x	19100109	-
			x		x			x	19100109	-

# Accessories



## Cooker accessories

DESCRIPTION	FOR MODELS	CODE	€
 KORE water column kit left		19044979	-
 KORE water column kit right		19044980	-
 KORE smooth Fry-top (350 x 300 mm)		19045076	-
 Wok pan adaptor		19045085	-
Kit 2 brass transmitters (1 x 5.25 kW + 1 x 8 Kw)	C-G920	19084551	-
Kit 2 high power brass transmitters (1 x 8 kW + 1 x 10.2 kW)	C-G920 H	19084552	-
Kit 4 brass transmitters (2 x 5.25 kW + 1 x 8 kW + 1 x 10.2 kW)	C-G940, C-G941, C-GE941	19084553	-
Kit 4 high power brass transmitters (3 x 8 kW + 1 x 10.2 kW)	C-G940 H, C-G941 H	19084554	-
Kit 6 brass transmitters (3 x 5.25 kW + 2 x 8 kW + 1 x 10.2 kW)	C-G960, C-G961, C-G961 OP	19084555	-
Kit 6 high power brass transmitters (5 x 8 kW + 1 x 10.2 kW)	C-G960 H, C-G961 H, C-G961 OP H	19084556	-

## Fryer accessories

DESCRIPTION	CODE	€
 2 small baskets for 15l	19078478	-
 1 large basket for 21l	19045077	-



## Fry-top accessories

DESCRIPTION	CODE	€
 KORE 0.5M fry-top guard	19045081	-
 KORE 1M fry-top guard	19045082	-
 Fry-top scraper	19045083	-





## Accessories for charcoals

DESCRIPTION	CODE	€
 KORE charcoal scraper - FE Grill	19045084	-
 KORE charcoal scraper - Stainless steel Grill	19058313	-

## Accessories for boiling pans

DESCRIPTION	CODE	€
 Kit two perforated baskets for 100 litres boiling pans	19060752	-
 Kit two perforated baskets for 150 litres boiling pans	19061190	-
 Couscoussier kit for pans	19052940	-

## Pasta cooker accessories



DESCRIPTION	CODE	€
 Pasta cooker baskets kit - 6x1/6 square	19036341	-
 Pasta cooker baskets kit - 6x1/6 round	19036342	-
 Pasta cooker baskets kit - 2x1/2	19036340	-
 Pasta cooker baskets kit - 4x1/4	19036344	-

## Tall chimney kit



DESCRIPTION	CODE	€
Tall chimney kit	19081001	-
 Tall chimney kit 1/4 M Kore 900 appliances	19080999	-
Tall chimney kit 1/2 M Kore 900 appliances	19080990	-
Tall chimney kit 1 M Kore 900 appliances	19081000	-

\* Can be installed in all appliances except electric fryers.

## Bain marie accessories

DESCRIPTION	CODE	€
 KORE filling tap kit left	19044981	-
 KORE filling tap kit right	19044982	-

## Machines with wheels

DESCRIPTION	CODE	€
 KORE kit of 4 wheels	19044983	-
 KORE kit of 2 fixed wheels	19044985	-

## Transformations to other voltages - "marine" version (\*)

Machines destined for ships, 440 V - 3 Phase, should be requested in the order indicating these data:

- Code for the standard appliance 400 V 3+N.

- Note for assembly 440 V - 3 phases without neutral.

DESCRIPTION	CODE	B-M-E 700-900	F-F-E 705-905	F-F-E 710-910	B-E9051	B-E9101	F-E7 ONE CONTAINER	F-E7 TWO CONTAINERS	SPE 710 MANUAL	OP-E 79 CONTAINER	OP-E 79 TWO CONTAINERS	M-E 710	F-E 9 ONE CONTAINER	F-E 9 TWO CONTAINERS	SPE 91X MANUAL	M-E 900	SPE 91 MOTORISED	€
Ship kit 16A	19087491	1	1	2														-
Ship kit 16A with Energy Regulator	19089410				1	2												-
Ship kit 20A	19087492						1	2	1									-
Ship kit 20A with Energy Regulator	19087493									1	2	1						-
Ship kit 40A	19087494												1	2	1			-
Ship kit with Transformer	19057294															1	1	-
230 III - Conversion to 230 V three phase without neutral	(*)																	-
230 1N - Conversion to 230 V single phase	(*)																	-

(\*): Consult the existence of a version for this voltage



Maximum performance  
in reduced spaces.



Access the website



Commercial video



Sales brochure

## 700 Series

Gas cookers.....	<b>063</b>
Gas solid tops with open burners.....	<b>065</b>
Gas solid tops.....	<b>066</b>
Paella cookers.....	<b>067</b>
Electric cookers.....	<b>068</b>
Electric solid tops.....	<b>069</b>
Induction cookers.....	<b>070</b>
Fry-tops.....	<b>071</b>
Grills.....	<b>073</b>
Pasta cookers.....	<b>075</b>
Boiling pans.....	<b>076</b>
Fryers.....	<b>077</b>
Chips scuttle.....	<b>078</b>
Tilting bratt pans.....	<b>079</b>
Bain marie.....	<b>080</b>
Neutral elements.....	<b>081</b>
Stands.....	<b>082</b>
Refrigerated stands.....	<b>083</b>
Configuration and finishings.....	<b>085</b>
Accessories.....	<b>091</b>

All gas cooking equipment should be fitted with gas governors:  
- LPG: 37 g/cm<sup>2</sup>  
- Natural Gas: 20 g/cm<sup>2</sup>



# Gas cookers



## General characteristics

- Stamped surface tops manufactured in 1.5 mm thick AISI-304 stainless steel
- Laser-cut joints and automatic welding. Hidden screws
- 397 x 580 mm double grates (397 x 290 mm for each burner) enabling the use of large pots and pans. The reduced distance of 75 mm between the central bars makes it possible to use pots with a very small diameter (8 cm), avoiding the risk of smaller pans tipping over.
- The grates are made of RAAF enamelled cast iron (resistant to alkaline and acid products, fire and high temperatures).
- Double-crown burners and diffusers made of nickel-plated cast iron which guarantee an even distribution of heat from the flame to the base of the pans, even for large pans. This therefore prevents heat from building up in a specific point and optimises energy transfer to the product.
- Burners of different strengths to adapt to containers and for use with different foods:
  - 5.25 kW (Ø 100 mm),
  - 8.0 kW (Ø 120 mm),
- Burners are easy to position
- Low-consumption pilot light and thermocouple located within the body of the burner for greater protection.
- Flexible stainless-steel gas pipes, facilitating internal manipulations in order to make repairs easier.

- Controls with a protective support base and system to prevent water infiltration.
- High-temperature enamelled cast iron flue protector which is flush with the grates therefore improving manoeuvrability, supporting larger containers and increasing the usable surface area.
- Access to components from the front.

## OVEN

- Possibility of choosing between a static gas oven with dimensions NG 2/1 or a side-opening English-style oven with dimensions 860 x 570 x 410 mm with a side-opening double door or an electric oven with dimensions NG 2/1.
- Cooking chamber made entirely of stainless steel, which makes cleaning easier and ensures greater hygiene.
- Trays are inserted sideways which improves manoeuvrability.
- Heating:
  - Gas: Tubular stainless-steel burner with pilot light and thermocouple and piezoelectric ignition.
  - Electric: Heating through stainless steel heating elements with selector switch for operation of the upper and/or inner part.
- Thermostatic valve for temperature control (125 - 310 °C).

- Rails on three height levels to offer different cooking options.
- Rails with anti-tipping system to prevent trays from overturning.
- Cast iron oven floor which guarantees better performance and uniform heat distribution.
- Fibreglass closing seal to improve the thermal efficiency of the oven and ensure its durability.
- Stamped oven frame and inner door, ensuring a better oven closure.
- Detachable oven door to facilitate repairs.

Optional accessories (See accessories page at the end of the chapter)

- Frying plate to place on 5.25 kW burners.
- Water column.
- Brass transmitters.

MODEL	GAS	CODE	GRILLS (mm)	BURNERS		OVEN		TOTAL POWER (kW)	DIMENSIONS	€
				5,25 KW	8 KW	SIZE	POWER (kW)			
<b>Top</b>										
C-G720	LPG	19068008	397x290	2	-	-	-	10,50	400x730x290	-
	NG	19074175								
C-G720 H	LPG	19068057	397x290	-	2	-	-	16,00	400x730x290	-
	NG	19074760								
C-G740	LPG	19060614	397x290	3	1	-	-	23,75	800x730x290	-
	NG	19073557								
C-G740 H	LPG	19068058	397x290	-	4	-	-	32,00	800x730x290	-
	NG	19074761								
C-G760	LPG	19068059	397x290	4	2	-	-	37,00	1200x730x290	-
	NG	19074762								
C-G760 H	LPG	19068110	397x290	-	6	-	-	48,00	1200x730x290	-
	NG	19074763								
<b>Gas static oven NG 2/1</b>										
C-G741	LPG	19058530	397x290	3	1	NG-2/1	8,60	32,35	800x730x850	-
	NG	19073558								
C-G741 H	LPG	19068112	397x290	-	4	NG-2/1	8,60	40,60	800x730x850	-
	NG	19074765								
C-G761	LPG	19071404	397x290	4	2	NG-2/1	8,60	45,60	1200x730x850	-
	NG	19073560								
C-G761 H	LPG	19071463	397x290	-	6	NG-2/1	8,60	56,60	1200x730x850	-
	NG	19074766								
<b>British style gas oven</b>										
C-GB761	LPG	19074812	397x290	4	2	860X570X410	8,60	45,60	1200x730x850	-
	NG	19074813								
C-GB761 R	LPG	19074814	397x290	4	2	860X570X410	8,60	45,60	1200x730x850	-
	NG	19074815								
C-GB761 H	LPG	19074816	397x290	-	6	860X570X410	8,60	56,60	1200x730x850	-
	NG	19074817								
C-GB761 RH	LPG	19074819	397x290	-	6	860X570X410	8,60	56,60	1200x730x850	-
	NG	19074820								
<b>Electric static oven NG 2/1</b>										
C-GE741	LPG	19074821	397x290	3	1	NG-2/1	6,00	29,75	800x730x850	-
	NG	19074822								
C-GE741 H	LPG	19074823	397x290	-	4	NG-2/1	6,00	38,00	800x730x850	-
	NG	19074824								

H MODELS: With high-power burners  
R MODELS: With wheels

## Gas solid tops with open burners



- 5.25 kW (Ø 100 mm),
- 8.0 kW (Ø 120 mm),
- Burners are easy to position.
- 10 mm-thick cast iron plate with rounded corners, 400 x 580 mm, and shield with 210 mm diameter.
- 5.25 kW burner beneath fry top.
- Low-consumption pilot light and thermocouple located within the body of the burner for greater protection.
- Flexible stainless-steel gas pipes, facilitating internal manipulation in order to make repairs easier.
- Controls with a protective support base and system to prevent water infiltration.
- High-temperature enamelled cast iron flue protector which is flush with the grates therefore improving manoeuvrability, supporting larger containers and increasing the usable surface area.

### OVEN

- Static oven size NG 2/1.
- Stainless steel cooking chamber which makes cleaning easier and ensures greater hygiene.
- Trays are inserted sideways which improves manoeuvrability.
- Rails on three height levels to offer different cooking options.
- Rails with anti-tipping system to prevent trays from overturning.
- Thermostatic valve for temperature control (125 - 310 °C).
- Tubular stainless-steel burner with pilot light and thermocouple and piezoelectric ignition.
- Cast iron oven floor which guarantees better performance and uniform heat distribution.
- Fibreglass closing seal to improve the thermal efficiency of the oven and ensure its durability.
- Stamped oven frame and inner door, ensuring better oven closure.
- Detachable oven door to facilitate repairs.

### OPTIONAL ACCESSORIES

- (see accessories page at the end of the chapter)
- Frying plate to place on 5.25 kW burners
  - Water column.
  - Brass transmitters.

### General characteristics

- Stamped surface tops manufactured in 1.5 mm thick AISI-304 stainless steel.
- Laser-cut joints and automatic welding. Hidden screws.
- 397 x 580 mm double grates (397 x 290 mm for each burner) enabling the use of large pots and pans. The reduced distance of 75 mm between the central bars makes it possible to use pots with a very small diameter (8 cm), avoiding the risk of smaller pans tipping over.
- The grates are made of RAAF enamelled cast iron (resistant to alkaline and acid products, fire and high temperatures).
- Double-crown burners and diffusers made of nickel-plated cast iron which guarantee an even distribution of heat from the flame to the base of the pans, even for large pans. This therefore prevents heat from building up in a specific point and optimises energy transfer to the product.
- Burners of different strengths to adapt to containers and for use with different foods

MODEL	GAS	CODE	BURNERS		SOLID TOP 5,25 kW	OVEN 8,6 kW	TOTAL POWER (kW)	STANDS	DIMENSIONS	€
			5,25 kW	8 kW						
<b>Top</b>										
C-G730-I	LPG	19073679	1	1	Left	-	18,50	-	800x730x290	-
	NG	19074769								
C-G730-D	LPG	19073680	1	1	Right	-	18,50	-	800x730x290	-
	NG	19074771								
C-G750	LPG	19070794	2	2	Centre	-	31,75	-	1200x730x290	-
	NG	19074772								
<b>With oven</b>										
C-G731-I	LPG	19073681	1	1	Left	1	27,1	-	800x730x850	-
	NG	19074773								
C-G731-D	LPG	19073682	1	1	Right	1	27,1	-	800x730x850	-
	NG	19074775								
C-G751	LPG	19074776	2	2	Centre	1	40,35	1	1200x730x850	-
	NG	19074777								

## Gas solid tops



### General characteristics

- Surface tops manufactured in 1.5 mm thick AISI-304 stainless steel.
- Laser-cut joints and automatic welding. Hidden screws.
- 10 mm-thick cast iron plate with rounded corners.
- Fry-top dimensions: 800 x 580 mm.
- Shield with 300 mm diameter.
- Refractory brick inside for improved heat use and distribution.
- Differentiated usage temperatures: 500 °C at the centre and 200 °C at the edges.
- Double-crown burner and diffuser made of cast iron which guarantee an even distribution of heat from the flame.
- Burner power: 8.4 kW.
- Low-consumption pilot light and thermocouple located within the body of the burner for greater protection.
- Flexible stainless-steel gas pipes, facilitating internal manipulation in order to make repairs easier.

- Controls with a protective support base and system to prevent water infiltration.
- High-temperature enamelled cast iron flue protector which is flush with the grates therefore improving manoeuvrability, supporting larger containers and increasing the usable surface area.
- Access to components from the front.

### OVEN

- Easy-to-use NG 2/1 static oven with controls located on the upper panel for improved ergonomics.
- Stainless steel cooking chamber which makes cleaning easier and ensures greater hygiene.
- Trays are inserted sideways which improves manoeuvrability.
- Rails on three height levels to offer different cooking options.
- Rails with anti-tipping system to prevent trays from overturning.

- Thermostatic valve for temperature control (125 - 310 °C).
- Tubular stainless-steel burner with pilot light and thermocouple and piezoelectric ignition.
- Cast iron oven floor which guarantees better performance and uniform heat distribution.
- Fibreglass closing seal to improve the thermal efficiency of the oven and ensure its durability.
- Stamped oven frame and inner door, ensuring better oven closure.
- Detachable oven door to facilitate repairs.

MODEL	GAS	CODE	SOLID TOP (mm)	BURNER 8,4 kW	OVEN		TOTAL POWER (kW)	DIMENSION S	€
					DIMENSIONS	POWER (kW)			
<b>Top</b>									
C-G710	LPG	19070754	800x580	1	-	-	8	800x730x290	-
	NG	19073645							
<b>With oven</b>									
C-G711	LPG	19073088	800x580	1	NG-2/1	8,60	16,6	800x730x850	-
	NG	19074767							

## Paella cookers



### General characteristics

- Surface tops manufactured in 1.5 mm thick AISI-304 stainless steel.
- Laser-cut joints and automatic welding. Hidden screws.
- Double-crown burner with four rows of flames per crown, guaranteeing an even distribution of heat from the flame to the bottom of the paella.
- Low-consumption pilot light and thermocouple.
- Flexible stainless-steel gas pipes, facilitating internal manipulation in order to make repairs easier.
- Controls with a protective support base and system to prevent water infiltration.

- High-temperature enamelled cast iron flue protector which is flush with the grates therefore improving manoeuvrability, supporting larger containers and increasing the usable surface area.
- Access to components from the front.

#### PAELLA OVEN.

- 665 x 665 x 325 mm static paella oven with controls located on the upper panel.
- Stainless steel cooking chamber which makes cleaning easier and ensures greater hygiene.

- Thermostatic valve for temperature control (125 - 310 °C).
- Tubular stainless-steel burner in the rear part operation with temperature gradient. Operation pilot light, piezoelectric ignition and thermocouple.
- Side-opening double door.

MODEL	GAS	CODE	BURNERS			OVEN		TOTAL POWER (kW)	DIMENSIONS	€
			OUTER	INNER	POWER (kW)	DIMENSIONS	POWER (kW)			
<b>Top</b>										
C-GP710	LPG	19074804	450	330	27	-	-	27,00	800x730x290	-
	NG	19074806								
<b>With oven</b>										
C-GP711	LPG	19074808	450	330	27	665x665x325	7,30	34,30	800x730x850	-
	NG	19074811								

## Electric cookers



### General characteristics

- Pressed surface tops manufactured in 1.5 mm thick AISI-304 stainless steel, with rounded edges, designed to prevent spilled liquid from pans from entering the interior of the oven.
- Stamped surface top with rounded corners for easy cleaning.
- Laser-cut joints and automatic welding. Hidden screws.
- Cast iron hot plates,
  - ROUND, 223 Ø (2.6 kW), hermetically fixed to the stamped surface top
  - SQUARE, 230 x 230 (2.6 kW), hermetically fixed to the stamped surface top
- Power regulation via selector with 7 positions
- Protection against overheating for each plate.
- High-temperature enamelled cast iron flue protector.

- Access to components from the front
- Easy connection and compliant with health standards.
- Machines with IPX5 grade water protection.

#### OVEN

- Easy-to-use NG 2/1 static oven with controls located on the upper panel for improved ergonomics.
- Stainless steel cooking chamber which makes cleaning easier and ensures greater hygiene.
- Trays are inserted sideways which improves manoeuvrability.
- Rails on three height levels to offer different cooking options.
- Rails with anti-tipping system to prevent trays from overturning.

- Thermostatic temperature control (125 - 310 °C).
- Heating through stainless steel heating elements with selector switch for operation of the upper and/or lower area.
- Cast iron oven floor which guarantees better performance and uniform heat distribution.
- Fibreglass closing seal to improve the thermal efficiency of the oven and ensure its durability.
- Stamped oven frame and inner door, ensuring better oven closure.
- Detachable oven door to facilitate repairs.

#### Voltage

- 400 V 3+N
- For other voltages, consult the options at the end of the chapter.

MODEL	CODE	PLATES		OVEN		TOTAL POWER (kW)	NEUTRAL CABINET	DIMENSIONS	€	
		(mm)	2,6 kW	DIMENSIONS	POWER (kW)					
<b>ROUND PLATES</b>										
<b>Top</b>										
C-E720	19068321	223	2	-	-	5,20	-	400x730x290	-	
C-E740	19067975	223	4	-	-	10,40	-	800x730x290	-	
C-E760	19068322	223	6	-	-	15,60	-	1200x730x290	-	
<b>With oven</b>										
C-E741	19068498	223	4	NG-2/1	6	16,40	-	800x730x850	-	
C-E761	19068645	223	6	NG-2/1	6	21,60	1	1200x730x850	-	
<b>SQUARE PLATES</b>										
<b>Top</b>										
C-E720Q	19072313	230x230	2	-	-	5,20	-	400x730x290	-	
C-E740Q	19072312	230x230	4	-	-	10,40	-	800x730x290	-	
<b>With oven</b>										
C-E741Q	19071619	230x230	4	NG-2/1	6	16,40	-	800x730x850	-	

## Electric solid tops with 4 cooking zones



### General characteristics

- Pressed surface tops manufactured in 1.5 mm thick AISI-304 stainless steel, with rounded edges, designed to prevent spilled liquid from pans from entering the interior of the oven.
- Stamped surface top with rounded corners for easy cleaning.
- Laser-cut joints, automatic welding and polished. Hidden screws.
- "Solid top" model with four elements underneath the 16 mm-thick, 13CrMo4 plate, distributed so that they independently heat the four quarters of the plate. Solid-top dimensions: 720 x 455 mm.
- Power control with 7 positions for each heating element which makes it possible to work with different temperature gradients on the plate.
- 2.6 kW heating power for each heat point.
- Protection in the event of overheating of each heat source.
- Thermostat that activates the cooling fan for the electric components.
- Safety thermostat that ensures that the machine does not operate in the event of the overheating of the components.
- High-temperature enamelled cast iron flue protector.
- Access to components from the front.
- Easy connection and compliant with Health & safety standards.
- Machines with IPX5 grade water protection.

#### OVEN

- Easy-to-use NG 2/1 static oven with controls located on the upper panel for improved ergonomics.
- Stainless steel cooking chamber which makes cleaning easier and ensures greater hygiene.
- Trays are inserted sideways which improves manoeuvrability.
- Rails on three height levels to offer different cooking options.
- Rails with anti-tipping system to prevent trays from overturning.

- Thermostatic temperature control (125 - 310 °C).
- Heating through stainless steel heating elements with selector switch for operation of the upper and/or lower area.
- Cast iron oven floor which guarantees better performance and uniform heat distribution.
- Fibreglass closing seal to improve the thermal efficiency of the oven and ensure its durability.
- Stamped oven frame and inner door, ensuring better oven closure.
- Detachable oven door to facilitate repairs.

#### VOLTAGE

- 400 V 3+N
- For other voltages, consult the options at the end of the chapter.

MODEL	CODE	SOLID TOP			OVEN		TOTAL POWER (kW)	DIMENSIONS	€
		MEASUREMENTS	COOKING AREAS	POWER (kW)	SIZE	POWER (kW)			
<b>TOP</b>									
C-E710	19068530	720 x 455	4	4X2,60	-	-	10,40	800x730x290	-
<b>WITH OVEN</b>									
C-E711	19068566	720 x 455	4	4X2,60	NG-2/1	6,00	16,40	800x730x850	-

## Induction cookers



### General characteristics

- 6 mm thick vitro ceramic glass, hermetically sealed in the 1.5 mm thick AISI-304 stainless steel surface top.
- Laser-cut joints and automatic welding. Hidden screws.
- Cooking areas demarcated by a circular Ø 260 mm screen print, with 5 kW power in each area, quick heating and ideal for à la carte service.
- Perfect control of cooking thanks to the energy regulator with 10 power levels which makes it possible to work at low temperatures for delicate recipes or at the highest temperature for quick service.
- Energy is only transferred to the area below the container and the rest of the vitro ceramic surface remains cold.
- It operates when it detects the presence of the container. When the container is removed, it stops heating.
- Consequently, it provides considerable energy savings (energy use is reduced by around 50% compared to gas burners).
- The working environment and atmosphere is more comfortable since the energy is concentrated at the base of the pan, heat radiation and dispersal are reduced and the cooking temperature is reached quickly.
- Safety against overheating. Error messages shown through flashing lights.
- High-temperature enamelled cast iron flue protector.
- Access to components from the front.
- Machines with IPX5 grade water protection.

#### VOLTAGE

- 400 V 3ph-
- For other voltages, consult the options at the end of the chapter.

MODEL	CODE	PLATES		TOTAL POWER (kW)	DIMENSIONS	€
		(Ø mm)	5,0 kW			
<b>Induction panels</b>						
C-I725	19057292	300	2	10,00	400x730x290	-
C-I745	19057293	300	4	20,00	800x730x290	-
<b>Wok</b>						
W-I705	19074716	300	1	5,00	400x730x290	-



# Fry-tops



## General characteristics

- Stamped surface tops manufactured in 1.5 mm thick AISI-304 stainless steel.
- Laser-cut joints, automatic welding and polished.
- 12 or 15 mm thick mild steel fry tops which are quick-heating and high power.
- Models with smooth, grooved and mixed hot plates (2/3 smooth + 1/3 grooved).
- Versions with 50-micron thick chrome surface for the three hot plate types.
- Electrically heated models with stainless steel heating elements; thermostatic temperature control, between 100 and 300 °C.
- Gas heated models with high efficiency burners (separate burners for whole-module models).
- Gas heated models with thermostatic temperature control (between 100 and 300 °C) or operation via safety thermostat with thermocouple.
- Burner ignition through electronic spark igniter. Therefore, the gas models do not need electricity for installation. With an access tube for manual ignition.
- Whole-module fry tops have two separate heating areas.
- Rapid reaction and recovery times of the fry-top temperature.
- The fry tops are welded to the stamped surface top.
- The stamped shell and its rounded edges and corners make cleaning much easier.
- The fry top is tilted towards the front to make it easier to collect grease and liquids.
- Fitted with an opening to collect cooking grease and a tray to store it which has capacity to store up to 2 litres depending on the model.
- Optional anti-splash side and rear guards, easy to remove.
- High-temperature enamelled cast iron flue protector.
- Access to components from the front.
- Machines with IPX5 grade water protection.

Optional accessories (See accessories page at the end of the chapter)

- Scraper (\*)
  - Anti-splash guard (in three parts to make cleaning easier).
- (\*) The models with a chrome surface include the scraper as standard.

Voltage of electric models

- 400 V 3+N. For other voltages, consult the options at the end of the chapter.



(\*) Models with chrome surface, scraper included

MODEL	GAS	CODE	PLATES				TOTAL POWER (kW)	DIMENSIONS (mm)	€
			TYPE	AREAS	(mm)	dm <sup>2</sup>			
<b>GAS FRY TOP</b>									
<b>Max-min valve</b>									
FT-G705 V L	LPG	19101392	L	1	328x468	15,40	7,50	400x730x290	-
	NG	19101409							
FT-G710 V L	LPG	19101391	L	2	728x468	34,10	15,00	800x730x290	-
	NG	19101410							
FT-G705 V R	LPG	19101405	R	1	328x468	15,40	7,50	400x730x290	-
	NG	19101491							
FT-G710 V R	LPG	19101408	R	2	728x468	34,10	15,00	800x730x290	-
	NG	19101412							
FT-G710 V L+R	LPG	19101413	L+R	2	728x468	34,10	15,00	800x730x290	-
	NG	19101414							
<b>Control by thermostat</b>									
FT-G705 L	LPG	19101249	L	1	328x468	15,40	7,50	400x730x290	-
	NG	19101415							
FT-G710 L	LPG	19101248	L	2	728x468	34,10	15,00	800x730x290	-
	NG	19101416							
FT-G705 R	LPG	19101417	R	1	328x468	15,40	7,50	400x730x290	-
	NG	19101404							
FT-G710 R	LPG	19101406	R	2	728x468	34,10	15,00	800x730x290	-
	NG	19101411							
FT-G710 L+R	LPG	19101407	L+R	2	728x468	34,10	15,00	800x730x290	-
	NG	19101418							
<b>Control by thermostat and chromium hot-plate</b>									
FT-G705 C L	LPG	19101394	L/C	1	328x468	15,40	7,50	400x730x290	-
	NG	19101395							
FT-G710 C L	LPG	19101393	L/C	2	728x468	34,10	15,00	800x730x290	-
	NG	19101401							
FT-G705 C R	LPG	19101396	R/C	1	328x468	15,40	7,50	400x730x290	-
	NG	19101400							
FT-G710 C R	LPG	19101397	R/C	2	728x468	34,10	15,00	800x730x290	-
	NG	19101402							
FT-G710 C L+R	LPG	19101398	L+R/C	2	728x468	34,10	15,00	800x730x290	-
	NG	19101403							
<b>ELECTRIC FRYTOPS</b>									
<b>Control by thermostat</b>									
FT-E705 L	-	19101390	L	1	328x468	15,40	5,00	400x730x290	-
FT-E710 L	-	19101247	L	2	728x468	34,10	10,00	800x730x290	-
FT-E705 R	-	19101419	R	1	328x468	15,40	5,00	400x730x290	-
FT-E710 R	-	19101420	R	2	728x468	34,10	10,00	800x730x290	-
FT-E710 L+R	-	19101399	L+R	2	728x468	34,10	10,00	800x730x290	-
<b>Control by thermostat and chromium hot-plate</b>									
FT-E705 C R	-	19101421	R/C	1	328x468	15,40	5,00	400x730x290	-
FT-E710 C R	-	19101423	R/C	2	728x468	34,10	10,00	800x730x290	-
FT-E705 C L	-	19101116	L/C	1	328x468	15,40	5,00	400x730x290	-
FT-E710 C L	-	19101422	L/C	2	728x468	34,10	10,00	800x730x290	-
FT-E710 C L+R	-	19101424	L+R/C	2	728x468	34,10	10,00	800x730x290	-

# Grills



## General characteristics

- Stamped surface tops manufactured in 1.5 mm thick AISI-304 stainless steel
- Laser-cut joints and automatic welding. Hidden screws
- Mild steel grills, dismountable without the need for tools, in 170 mm wide sections.
- The mild steel grills are reversible, with different finishes on each side:
  - Tilted and grooved with ridges for meat
  - Horizontal and flat for fish and vegetables
- These grills reach a very high temperature (400 °C), meaning that the surface of the product is quickly sealed and inside it remains much juicier.
- The models with stainless steel grills are manufactured using "Z" shaped AISI-304 stainless steel slats to make cleaning easier.
- Fitted with an opening to collect cooking grease and a tray to store it.
- Machines are fitted with removable 130 mm high guards to prevent splashes, made of stainless steel.

### ELECTRIC COUNTERTOP MODELS

- Group of stainless steel covered elements upon which you can cook food directly (a group of 3 elements for half-sized module models and 2 groups for whole module models).
- Water tray for safety. It also allows an adequate level of humidity to be reached for optimum cooking conditions.



### GAS COUNTERTOP MODELS

- Group of high-efficiency tube burners, (a group of two burners for half-sized module models, two groups for whole module models).
- Independent control for each group of burners via a safety valve with a thermocouple.
- Burners turned on using Piezo electric ignition.
- The burners heat ceramic stones that sit on a supporting rack, so that they can then heat food on the grill.

### GAS FLOOR MODELS

- Group of three high-efficiency tube burners, with a radiant deflector (a group of three burners for half-sized module models, two groups for whole module models).
- Independent control for each group of burners via a safety valve with a thermocouple.
- Burners turned on using electric multi-spark ignition. With an access tube for manual ignition.
- The fat collection trays provide the option of adding water into them, and thanks to heat radiated from the gas burners or electrical elements, a low intensity steam is generated, causing the roast to be carried out in a humid environment.

Optional accessories: (See accessories page at the end of the chapter)

-  Special scraper with two profiles for models with cast iron grill.
-  Special scraper adapted for models with stainless steel grill.

MODEL	GAS	CODE	GRIDS				TOTAL POWER (kW)	DIMENSIONS (mm)	€	
			TYPE	AREAS	QUANTITY	(mm) dm <sup>2</sup>				
<b>GAS GRILLS</b>										
Countertop										
B-G705 I	LPG	19074781	Inox	1	1	515x344	17,72	8,10	400x730x290	-
	NG	19074782								
B-G705	LPG	19074120	Mild steel	1	2	515x172	17,72	8,10	400x730x290	-
	NG	19074779								
B-G710 I	LPG	19072463	Inox	2	2	515x344	35,43	16,20	800x730x290	-
	NG	19074784								
B-G710	LPG	19067288	Mild steel	2	4	515x172	35,43	16,20	800x730x290	-
	NG	19074783								
Ground										
B-G7051 I	LPG	19078755	Inox	1	1	515x344	17,72	8,1	400x730x850	-
	NG	19081688								
B-G7051	LPG	19078909	Mild steel	1	2	515x172	17,72	8,1	400x730x850	-
	NG	19081687								
B-G7101 I	LPG	19078771	Inox	2	2	515x344	35,43	16,2	800x730x850	-
	NG	19081689								
B-G7101	LPG	19078905	Mild steel	2	4	515x172	35,43	16,2	800x730x850	-
	NG	19081700								
<b>ELECTRIC GRILLS</b>										
Countertop										
B-E705 I	-	19074788	Inox	1	1	270x430	11,61	4,08	400x730x290	-
B-E710 I	-	19070294	Inox	2	1	545x430	23,44	8,16	800x730x290	-

## Pasta cookers



### General characteristics

- Surface tops manufactured in 1.5 mm thick AISI-304 stainless steel.
- Laser-cut joints, automatic welding and polished.
- 1.5 mm thick AISI-316L stainless steel wells built into the surface top.
- 2 well sizes
  - GN-2/3 wells, with 26 litre capacity
  - GN-1/1 wells, with 40 litre capacity
- The well is filled through the inlet solenoid valve with a two-position switch: average and high-speed filling.
- Well drainage through a mechanical ball valve which is resistant to high temperatures and has a safety overflow.

- Automatic safety system to stop the current if the water runs out.
  - Controls with a protective support base and system to prevent water infiltration.
  - Machines with IPX5 grade water protection.
- #### GAS MODELS
- High-performance stainless-steel burner located outside of the well with a combustion chamber that enables heating of the base and sides of the well (up to the minimum filling level)
  - Burner ignition through electronic spark igniter. With an access tube for manual ignition
  - Heating controlled through safety valve.

#### ELECTRIC MODELS

- AISI 304 stainless-steel heating elements located inside the well to directly heat the water.
  - Heating controlled through energy regulator.
  - Voltage: 400 V 3+N. For other voltages, consult the options at the end of the chapter.
- #### Standard provision
- 26 L models: 2 x 1/3 baskets per well
  - 40 L models: 3 x 1/3 baskets per well
- #### Optional accessories: (See accessories page at the end of the chapter)
- 6 x 1/6 square baskets kit
  - 6 x 1/6 round baskets kit
  - 4 x 1/4 baskets kit
  - 2 x 1/2 baskets kit

MODEL	GAS	CODE	WELL		TOTAL POWER (kW)	DIMENSIONS (mm)	€
			QUANTITY	SIZE BASKETS (1/3)			
<b>Gas pasta cookers</b>							
CP-G7126	LPG	19071621	1	NG-2/3	10,00	400x730x850	-
	NG	19074728					
CP-G7226	LPG	19071360	2	NG-2/3	20,00	800x730x850	-
	NG	19074729					
CP-G7140	LPG	19098553	1	NG-1/1	16,50	400x730x850	-
	NG	19098554					
CP-G7240	LPG	19098555	2	NG-1/1	33,00	800x730x850	-
	NG	19098556					
<b>Electric pasta cookers</b>							
CP-E7126	-	19071569	1	NG-2/3	9,00	400x730x850	-
CP-E7226	-	19072437	2	NG-2/3	18,00	800x730x850	-
CP-E7140	-	19074747	1	NG-1/1	12,00	400x730x850	-
CP-E7240	-	19074780	2	NG-1/1	24,00	800x730x850	-

## Boiling pans



### General characteristics

- Surface tops manufactured in 1.5 mm thick AISI-304 stainless steel.
- Laser-cut joints, automatic welding and polished. Hidden screws.
- Lid with a front handle designed to prevent burns. Diagonal 70° opening.
- Drainage hole to redirect possible liquid spillages.
- 80-litre AISI-304 stainless-steel well built into the surface top using robotic welding, with a 2 mm-thick AISI 316L stainless steel well base.
- Well filled with cold or hot water through solenoid valves activated by a single switch located on the front panel.
- Well drainage through G1-1/2" UNI ISO 228 safety valve with athermic handle, safe and effortless.
- Filter for well drainage made of AISI-304 stainless-steel which is robust, reliable and easy to remove.
- Controls with a protective support base and system to prevent water infiltration.

- Indicator light to show when the machine is connected and when it is heating.
- IPX5 level protection.

#### DIRECT FLAME MODELS

- High-performance stainless-steel tubular burner with optimised combustion and sequential operation. Controlled by an energy regulator which enables slower cooking.
- Heating of the burner at the base of the boiling pan is evenly distributed, resulting in gradual heating of the contents of the well.
- Possibility of regulating heating of the burner as there are different levels of power.
- Burner is lit by spark ignition. Indirect flame models or bain-marie
- Bain-marie chamber surrounding the well with an automatic filling system
- Automatic control of the level of the chamber with three-way safety system pressure switch to control pressure in the chamber, limiter thermostat to prevent overheating of the chamber and overpressure safety valve.
- Automatic clearing of the chamber.
- Heating at the base of the boiling pan acts on the water in the surrounding chamber so that the saturated steam produced at a temperature of 107 °C evenly heats the base and sides of the well.

#### GAS MODELS

- High-performance stainless-steel tubular burner with optimised combustion.
- Controlled by energy regulator and pressure switch enabling lower energy and water use.
- Burner is lit by spark ignition.

#### ELECTRIC MODELS

- Heated through elements located in the lower part of the bain-marie chamber.
- Heating controlled through energy regulator and pressure switch.
- Voltage: 400 V 3+N. For other voltages, consult the options at the end the chapter.

MODEL	HZ	GAS	CODE	TANKS		TOTAL POWER (kW)	DIMENSIONS (mm)	€
				D X H	VOLUME (l)			
<b>Gas boiling pans *</b>								
<b>Direct fire</b>								
M-G710	50	LPG	19061151	Ø420x605	80	17,00	800x730x850	-
		GN	19074790					
Indirect heating or bain marie								
M-G710 BM	50	LPG	19066324	Ø420x605	80	17,00	800x730x850	-
		GN	19074807					
<b>Electric boiling pans</b>								
Indirect heating or bain marie								
M-E710 BM	-	-	19067268	Ø420x605	80	11,00	800x730x850	-

(\*): Check availability on other frequencies.

## Fryers



### General characteristics

- Surface tops manufactured in 1.5 mm thick AISI-304 stainless steel.
  - Laser-cut joints, automatic welding and polishing Hidden screws.
  - 8 L electric countertop models and 15 L gas and electric floor models.
  - Wells built into the surface top with robotic welding and polished.
  - Cold area in the lower part of the well which helps to preserve the characteristics and quality of the oil used for longer.
  - Thermostatic temperature control, between 60 and 200 °C.
  - Safety thermostat in all models.
  - Fitted with individual lids for each well.
  - Drainage of oil through a mechanical ball valve which is robust, reliable and resistant to high temperatures.
- For 8 L models, the discharge control is

located in the control panel.  
- High power machines that heat up quickly and have a high power - litre ratio (up to 1.00 kW/litre).

#### GAS MODELS

- Gas models with three longitudinal heat transfer tubes built into the well.
- High-efficiency gas burners
- Flue flush with the rest of the machines thanks to the perfect combustion achieved.

#### ELECTRIC MODELS

- Electric models with AISI 304 stainless steel heating elements located inside the well which can be tilted by over 90° to ensure perfect cleaning.

- Voltage: 400 V 3+N. For other voltages, consult the options at the end of the chapter.

#### Baskets provided:

- 8 L fryers: 1 small basket per well (125 x 280 x 100 mm)
- 15 L fryers: 1 large basket per well (250 x 280 x 100 mm).

#### Optional accessories:

- (See accessories page at the end of the chapter)
- 15 L fryers: small basket (125 x 280 x 100 mm).

MODEL	HZ	CODE		TANKS			TOTAL POWER (kW)	DIMENSIONS (mm)	€
		LPG	NG	QUANTITY	VOLUME (l)	BASKETS			
<b>Gas Fryers*</b>									
F-G7115	50	19074143	19074785	1	1x15	1 large	15,00	400x730x850	-
F-G7215	50	19074791	19074794	2	2x15	2 larges	30,00	800x730x850	-
<b>Electric Fryers</b>									
F-E7108	-	19072100		1	1x8	1 small	6,00	400x730x290	-
F-E7208	-	19072444		2	2x8	2 smalls	12,00	800x730x290	-
F-E7115	-	19071300		1	1x15	1 large	12,00	400x730x850	-
F-E7215	-	19071455		2	2x15	2 larges	24,00	800x730x850	-

(\*): Check availability on other frequencies.

## Chips scuttle



### General characteristics

- Half-module electrically heated machine, heated by infrared light located at the back of the machine which is activated by the ON/OFF switch.
- Surface top manufactured in 1.5 mm thick AISI-304 stainless steel.

- Laser-cut joints, automatic welding and polished. Hidden screws.
- Well built into the surface top with capacity for 150 mm high Gastronorm NG-1/1 recipient.

- Fitted with a removable, perforated, stainless-steel filter which is tilted to remove excess oil from the fryer.
- Controls with a system to prevent water infiltration, IPX5 grade protection.

MODEL	CODE	WELLS	TOTAL POWER (kW)	DIMENSIONS (mm)	€
 MF-E705	19072598	NG-1/1	1,00	400x730x290	-



# Tilting bratt pans



## General characteristics

- Laser-cut joints, automatic welding and polished. Hidden screws.
- Lever system to raise the well. The well can be raised until it is vertical to drain it completely.
- Entire machine structure made of stainless steel.
- Well designed with rounded corners and no edges, with a large opening for unloading to facilitate all cooking and cleaning operations.
- The great thickness of the well base (10 mm) guarantees even heat distribution.
- Well filled with water through a solenoid valve which is operated by a switch on the front of the machine. The filling pipe is located at the back of the machine.
- Double-walled lid with a draining rack at the back to redirect condensation water towards the well interior.
- The closed lid is the same height as surface tops of the range and since it does not have any protruding element or reinforcement, it can be used as a worktop.
- Compensation system to prevent sharp falls.
- Front access lid handle.
- Electrically heated using stainless steel heating elements located below the base of the well.
- Gas heating with high-efficiency stainless steel burners made of four tubes which are activated and controlled by a safety valve with a thermocouple.
- Thermostatic temperature control of the well floor, between 50 and 300 °C.

- Heating through burner tubes or electric heating elements located in the base of the well with, together with the great thickness of the well base, ensure maximum uniformity in heat distribution in all cases, guaranteeing consistent cooking.

Voltage of electric models  
- 400 V 3+N. For other voltages, consult the options at the end of the chapter.

MODEL	HZ	CODE		RAISING SYSTEM	TANK TYPE	CAPACITY (l)	SURFACE		TOTAL POWER (kW)	DIMENSIONS (mm)	€
		LPG	NG				(mm)	(dm²)			

### Gas tilting bratt pans

SB-G710	50-60	19058021	19074854	Manual	Inox	60	734x464	34	15	800x730x850	-
---------	-------	----------	----------	--------	------	----	---------	----	----	-------------	---

### Electric tilting bratt pans

SB-E710	-	19057670		Manual	Inox	60	734x464	34	10	800x730x850	-
---------	---	----------	--	--------	------	----	---------	----	----	-------------	---

# Bain maries



## General characteristics

- Surface tops manufactured in 1.5 mm thick AISI-304 stainless steel.
- Laser-cut joints, automatic welding and polished. Hidden screws.
- Wells that can be used with different types of Gastronorm containers of different sizes, 150 mm high, and with the following dimensions:
  - Half-module: NG-1/1, with 17 litre capacity.
  - Whole-module: NG-2/1, with 30 litre capacity.
- AISI-304 stainless steel wells built into the surface top.
- Gravity drainage: simple well drainage

- through removal of the overflow pipe.
- Thermostatic temperature control of the water, between 30 and 90 °C.
- Controls with a protective support base and system to prevent water infiltration (IPX5 protection).
- GAS MODELS**
  - Insulated combustion chamber which reduces heating of the components.
  - High-efficiency stainless steel burner located outside the well.
  - Pilot light via piezo ignition.
  - Tube for alternative manual ignition.

- Does not require electrical installation.
- ELECTRIC MODELS**
  - AISI 304 stainless steel heating elements located outside the well.
  - Safety thermostat.
  - Standard provision:
    - 2 crossbars to support Gastronorm containers.
    - Containers not included.
  - Accessory (See accessories page at the end of the chapter)
    - Filling valve.

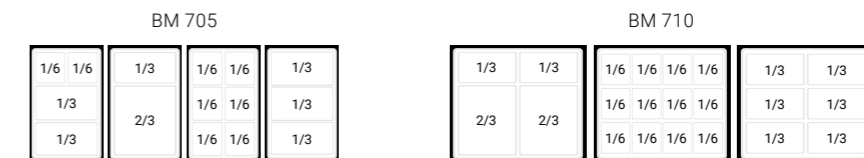

MODEL	GAS	CODE	TANK	TOTAL POWER (kW)		DIMENSIONS (mm)	€
				SIZE	VOLUME (l)		

### Gas Bain maries

BM-G705	LPG	19069826	NG-1/1	17	3,20	400x730x290	-
	NG	19073060					
BM-G710	LPG	19071631	NG-2/1	30	6,40	800x730x290	-
	NG	19074727					

### Electric Bain maries





BM-E705	-	19071437	NG-1/1	17	2,00	400x730x290	-
BM-E710	-	19071800	NG-2/1	30	6,00	800x730x290	-

## Neutral elements



### General characteristics

- Surface top manufactured in 1.5 mm thick AISI-304 stainless steel.
- Laser-cut joints and automatic welding.
- Hidden screws.
- Machines designed to attach to a filling valve or water column at the back.
- High-temperature enamelled cast iron flue trim.

MODEL	CODE	DRAWERS		DIMENSIONS (mm)	€
		QUANTITY	(mm)		
 EN-7025	19076626	-	-	200x730x290	-
 EN-705	19056719	-	-	400x730x290	-
 EN-710	19056790	-	-	800x730x290	-
 EN-705 C	19068696	1	300x590x105 (válido GN-1/1)	400x730x290	-
 EN-710 C	19068697	1	700x590x105	800x730x290	-

\* It can only be placed in central blocks or murals without verticality.

## Stands



### General characteristics

- Manufactured with a solid structure in AISI-304 stainless steel.
- Hidden screws.
- Can be quickly connected to serve as a support for surface top elements from the KORE 700 range.
- Can be used as an open storage element.
- Designed to be attached to optional kits.
- Doors.
- 2 NG drawers (for MB-705 model).
- Rails for NG containers, 5 levels (for MB-705 model, compatible with the doors kit).

MODEL	CODE	DOORS IN OPTION (NOT INCLUDED)	DRAWERS	GUIDES (5 LEVELS)	DIMENSIONS (mm)	€
MB-7025	19076625	-	-	-	200x660x600	-
MB-705	19057229	1	-	-	400x660x600	-
MB-705 C	19067227	-	2	-	400x660x600	-
MB-705 G	19074825	1	-	1	400x660x600	-
MB-710	19057290	2	-	-	800x660x600	-
MB-715	19057291	3	-	-	1200x660x600	-

### Kits for stands

MODEL	CODE	DESCRIPTION	€
 DOOR KIT	19040900	The kit allows the door to be reversible, so that it can be assembled to open to the left or to the right. The number of doors depends on the stand to which they are to be mounted.	-

## Refrigerated stands



### General characteristics

- Structure built in AISI-304.
  - Sealed compressor with ventilated condenser.
  - Copper pipe evaporator with aluminum wings.
  - 50 mm injected polyurethane insulation with a density of 40kg/m<sup>3</sup>.
  - BP models with panoramic door opening and automatic closing device with a stay open feature above 90°.
  - Height adjustable stainless-steel legs (from 130mm to 190mm) allows adjusting the overall height of the counter from 580 to 640mm.
  - Forced air refrigeration system
  - Working temperature: -2 °C, +8 °C, at room temperature of 38 °C.
  - Tested in climate class 4.
  - Electronic temperature and defrosting control and display.
  - W model with GN 1/1 holding capacity drawers.
  - W2 model with a full-length flat drawer with GN2/1 holding capacity and equipped with 5 crosspieces to support different combinations of GN containers.
  - Stainless steel back panel.
- Options:
- Kit of 6 castors (2 with brakes). Factory fitted.
  - 60Hz

MODEL	COOLANT	Hz.	CODE	N. DOORS AND DRAWERS	ENERGY EFFICIENCY CLASS	GROSS CAPACITY (L)	ANNUAL ENERGY CONSUMPTION (kWh)	ELECTRIC POWER(W)	DIMENSIONS (MM)	€
<b>Models with doors</b>										
CCP7-2G	R290	50	19089620	2	B	110	657	249	1200x630x590	-
<b>Models with 2/3 drawers</b>										
CCP7-2G W	R290	50	19089621	2 x GN 2/3	B	110	714	249	1200x630x590	-
<b>Models with full length flat drawers</b>										
CCP7-2G W2	R290	50	19089622	2 x GN 4/3	c	110	777	262	1200x630x590	-
<b>Models with doors</b>										
CCP7-3G	R290	50	19089623	3	D	169	1113	249	1.600x630x590	-
<b>Models with 2/3 drawers</b>										
CCP7-3G W	R290	50	19089624	3 x GN 2/3	D	169	1113	249	1.600x630x590	-

# Configuration and finishes

## KORE Modular 700

Configurable blocks KORE 700



BLOCK TYPE	CONFIGURATION		ASSEMBLY KITS		VERTICALITY			SIDE FINISHES		PLINTH	
	WALL	CENTRAL	ADDITIONAL STRUCTURE	"STANDARD SUPPORTS"	SUPPORTS FOR MACHINERY	RACKS	SIDE TRIM	FLAT PANEL	STANDARD	SPECIAL	
KITCHEN		KORE									
	KORE	KORE									
<b>GROUND</b>											
	700	700/700 900/700	-	o	o	o	o	o	o	o	
<b>BRIDGE</b>											
	700	700/700 900/700	x	o	o	o	o	o	o	o	
<b>SUSPENDED</b>											
	700	700/700 900/700	x	o	o	o	*	o	-	o	

- : Does not need
- x: Mandatory
- o: Optional
- : Serial
- \*: Consult

# Assembly kits

## Bridge block kit

Structure to assemble a BRIDGE block

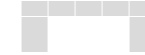

CONFIGURATION		BLOCK LENGTH	CODE	€
CENTRAL	WALL	MODULES	REF.	
		1M	19044954	-
		1.5M	19044955	-
KORE		2M	19044956	-
KORE	KORE	2.5M	19044957	-
		3M	19044958	-
		3.5M	19044959	-
		4M	19044960	-

\* Order 1 unit per bridge side (wall block). If it is a central block, 2 units will be required, 1 for each side.

## Suspended block kit

Structure to assemble a SUSPENDED block



CONFIGURATION		BLOCK LENGTH	CODE	€		
BLOCK TYPE		MODULES	REF.			
Wall	KORE	2M	19076826	-		
		2.5M	19076827	-		
		3M	19076828	-		
		3.5M	19076829	-		
		4M	19076830	-		
		4.5M	19076831	-		
		5M	19076832	-		
		5.5M	19076833	-		
		6M	19076834	-		
		Central	KORE KORE	2M	19076836	-
				2.5M	19076837	-
				3M	19076838	-
3.5M	19076839			-		
4M	19076840			-		
4.5M	19076841			-		
		5M	19076842	-		
		5.5M	19076843	-		
		6M	19076844	-		

\*The kit includes side termination with smooth paneling



# Verticality

## Supports

Supports for verticality in GROUND, BRIDGE and SUSPENDED blocks



SUPPORTS	CONFIGURATION	CODE	€
<b>Type</b>	<b>With or without additional elements</b>	<b>Ref.</b>	
<b>Standard</b> 100x100mm profile	Standard (no added items)	19095368	-
	Standard with tap (included in profile)	19095390	-
	Standard with 220V plug (included in profile)	19095369	-
<b>Special</b> for machinery	For iKORE 0623 oven	19095391	-
	For salamander	19095392	-

Notes:

\* Select a combination of 2 supports. Total = 2 units/codes, even if they are repeated.

\* Not suitable for suspended wall blocks.

\* Must be placed on neutral parts measuring 1M on both sides.

## Racks

Racks for verticality in GROUND, BRIDGE and SUSPENDED blocks

BLOCK LENGTH	WALL KORE BLOCK		CENTRAL KORE/KORE BLOCK					
	2 X STANDARD SUPPORTS		2 X STANDARD SUPPORTS		1 X STANDARD SUPPORT + 1 X SPECIAL SUPPORT		2 X SPECIAL SUPPORTS	
MODULES	CODE	€	CODE	€	CODE	€	CODE	€
2M	19096849	-	19096559	-	-	-	-	-
2.25M	19096849	-	19096559	-	-	-	-	-
2.5M	19096852	-	19096116	-	19104184	-	-	-
2.75M	19096852	-	19096116	-	19104184	-	-	-
3M	19096853	-	19096349	-	19104185	-	19104186	-
3.25M	19096853	-	19096349	-	19104185	-	19104186	-
3.5M	19096854	-	19096532	-	19104187	-	19104188	-
3.75M	19096854	-	19096532	-	19104187	-	19104188	-
4M	19096855	-	19096535	-	19104189	-	19104190	-
4.25M	19096855	-	19096535	-	19104189	-	19104190	-
4.5	19096856	-	19096525	-	19104191	-	19104192	-
4.75M	19096856	-	19096525	-	19104191	-	19104192	-
5M	19096858	-	19096526	-	19104193	-	19104194	-

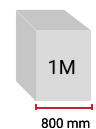

\* 1M = 1 module = 800mm

# Plinths

## Modular plinths 700

Plinths for GROUND and BRIDGE blocks



PLINTH FINISH	BLOCK LENGTH MODULES	WORKTOP HEIGHT		CODES		€
		850	900	ELECTRIC	GAS*	
0.5M	x	x		19081991	19081990	-
			x	19100199	19100454	-
0.75M	x	x		19087898	19087869	-
			x	19100200	19100455	-
1M	x	x		19081809	19081800	-
			x	19100201	19100456	-
1.25M	x	x		19087897	19087868	-
			x	19100202	19100457	-
1.5M	x	x		19081808	19081789	-
			x	19100203	19100458	-
1.75M	x	x		19087896	19087867	-
			x	19100204	19100459	-
2M	x	x		19081807	19081788	-
			x	19100205	19100470	-
2.25M	x	x		19087895	19087866	-
			x	19100433	19100471	-
2.5M	x	x		19081806	19081787	-
			x	19100434	19100472	-
2.75M	x	x		19087894	19087865	-
			x	19100435	19100473	-
3M	x	x		19081805	19081786	-
			x	19100436	19100474	-
3.25M	x	x		19087893	19087706	-
			x	19100437	19100475	-
3.5M	x	x		19081804	19081785	-
			x	19100438	19100476	-
3.75M	x	x		19087892	19087864	-
			x	19100478	19100477	-
4M	x	x		19081803	19081784	-
			x	19100479	19100490	-
4.25M	x	x		19087891	19087863	-
			x	19100491	19100492	-
4.5M	x	x		19081802	19081783	-
			x	19100494	19100495	-
4.75M	x	x		19087890	19087862	-
			x	19100497	19100498	-
5M	x	x		19081801	19081782	-
			x	19100499	19100500	-

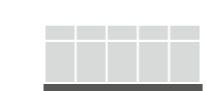

\* If the block consists of a gas machine, select the code shown in the gas column.

\* 1M = 1 módulo = 800mm

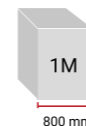

## Special plinth for V-shaped fryer

Divided plinth for V-shaped fryer

PLINTH FINISH	MODEL V-SHAPED FRYER	WORKTOP HEIGHT		CODES REF.	€
		850	900		
F-(E/G)9123	x	x		19107373	-
			x	19107374	-

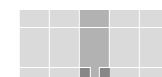

# Side finishes

## Side finish for 700 modular blocks

Side ends for GROUND and BRIDGE blocks



FINISH	CONFIGURATION	VERTICALITY		WORKTOP HEIGHT		SIDE		CODE	€						
		YES	NO	850	900	SIDE A	SIDE B								
SIDE TRIM  Side trim ergonomic/aesthetical (+90mm each side)	WALL OR CENTRAL BLOCK	A	KORE 700	B	Wall	x	x		x	19098681	-				
						x	x			x		19098680	-		
						Top view:		x		x		x		19097858	-
						x		x			x		19097898	-	
						x	x			x			19098882	-	
						x	x				x		19098706	-	
						x		x		x			19098932	-	
						x		x			x		19098911	-	
						x	x			x			19098705	-	
						x	x	x		x			19098898	-	
		A	KORE 700	A	Central	x		x		19097849	-				
		x		x		x			19099427	-					
		x	x			x			19098874	-					
		x	x				x		19098817	-					
		x		x		x			19098908	-					
		A	KORE 900	B	Central	x		x		19098907	-				
		x		x		x			19098203	-					
		x		x			x		19098686	-					
		x		x	x		x		19098910	-					
		x		x			x		19098909	-					
Top view:		x	x			x		19100012	-						
x		x				x		19099919	-						
x		x		x				19100015	-						
A	KORE 700	B	Wall	x		x		19100014	-						
x		x		x				19099893	-						
x		x			x			19099891	-						
x		x		x				19099894	-						
x		x			x			19099892	-						
A	KORE 700	A	Central	x		x		19106940	-						
x		x		x				19106941	-						
x		x		x				19106942	-						
x		x			x			19106943	-						
x		x			x			19106946	-						
x		x				x		19106949	-						
A	KORE 900	B	Central	x		x		19106990	-						
x		x		x				19106991	-						
x		x			x			19106992	-						
x		x				x		19106993	-						
x		x		x				19106994	-						
x		x			x			19106995	-						

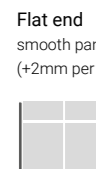

## Side finish for suspended blocks

Side ends for SUSPENDED blocks



\* Side finishes are included in the SUSPENDED assembly kits

## Inner finishes for bridge blocks

Side ends for BRIDGE block interiors



CONFIGURATION	WORKTOP HEIGHT		CODE	€
	850	900		
BRIDGE BLOCKS			REF.	
L R	x		19107489	-
		x	19107510	-

\*Unitary units per side. Select as many as needed.

## Special side finishes for tilting bratt pans

Side ends for blocks with a tilting pan at their ends





FINISHING	CONFIGURATION	VERTICALITY		WORKTOP HEIGHT		SIDE		CODE	€			
		SI	NO	850	900	IZDA (L)	DCHA (R)					
TYPE OF FINISHING	CENTRAL OR WALL	KORE 700	Wall	x	x			x		19081815	-	
				x	x				x		19081816	-
				x		x		x			19100086	-
				x		x			x		19100085	-
				x	x			x			19100039	-
				x		x			x		19100037	-
				x		x		x			19100120	-
				x		x			x		19100038	-
				x	x			x			19081815	-
				x	x					x	19081816	-
		x		x		x			19100086	-		
		x		x		x		x	19100085	-		
		x		x			x		19100034	-		
		x		x				x	19100032	-		
		x		x		x			19100035	-		
		x		x			x		19100033	-		



Flat panel  
Smooth finish  
(+2mm per side)

# Accessories



## Cooker accessories

DESCRIPTION	CODE	€
 KORE water column kit left	19076661	-
 KORE water column kit right	19076662	-
 Kore smooth fry-top (350 x 300 mm)	19078476	-
 Wok pan adaptor	19078477	-
Kit 2 brass transmitters (1 x 5.25 kW + 1 x 8 Kw) C-G720	19084557	-
Kit 2 high power brass transmitters (1 x 8 kW + 1 x 10.2 Kw) C-G720 H	19084558	-
Kit 4 brass transmitters (2 x 5.25 kW + 1 x 8 kW + 1 x 10.2 kW) C-G740, C-G741, C-GE741	19084559	-
Kit 4 high power brass transmitters (3 x 8 kW + 1 x 10.2 kW) C-G750, C-G751	19084571	-
Kit 6 brass transmitters (3 x 5.25 kW + 2 x 8 kW + 1 x 10.2 kW) C-G740 H, C-G741 H, C-GE741 H	19084570	-
Kit 6 high power brass transmitters (5 x 8 kW + 1 x 10.2 kW) C-G760, C-G761, C-GB761, C-GB761 R	19084572	-
Kit 6 high power brass diffusers (6 x 8 kW) C-G760H,C-G761 H,C-GB761 H,C-GB761 RH	19084573	-

## Fryer accessories

DESCRIPTION	CODE	€
 2 small baskets for 15l	19078478	-

## Fry-top accessories

DESCRIPTION	CODE	€
 KORE 0.5M fry-top guard	19078921	-
 KORE 1M fry-top guard	19078920	-
 Fry-top scraper	19045083	-

## Accessories for charcoals

DESCRIPTION	CODE	€
 KORE charcoal scraper - FE Grill	19045084	-
 KORE charcoal scraper - Stainless steel Grill	19058313	-







## Bain marie accessories

DESCRIPTION	CODE	€
 KORE filling tap kit	19074221	-

## Machines with wheels

DESCRIPTION	CODE	€
 KORE kit of 4 wheels	19044983	-
 KORE kit of 2 fixed wheels	19044985	-

## Pasta cooker accessories

DESCRIPTION	CODE	€
 Pasta cooker baskets kit 40 L - 6x1/6 square	19036341	-
 Pasta cooker baskets kit 40 L - 6x1/6 round	19036342	-
 Pasta cooker baskets kit 40 L - 4x1/4	19036344	-
 Pasta cooker baskets kit 40 L - 2x1/2	19036340	-
 Pasta cooker baskets kit 26 L - 4x1/6 square	19076807	-
 Pasta cooker baskets kit 26 L - 4x1/6 round	19076809	-

## Tall chimney kit

DESCRIPTION	CODE	€
Tall chimney kit 1/4 M Kore 700 appliances	19081053	-
 Tall chimney kit 1/2 M Kore 700 appliances	19081052	-
Tall chimney kit 1 M Kore 700 appliances	19081051	-
Tall chimney kit 1 1/4 M Kore 700 appliances	19081054	-

\* Can be installed in all appliances except electric fryers.

## Transformations to other voltages - "marine" version (\*)

Machines destined for ships, 440 V - 3 Phase, should be requested in the order indicating these data:

- Code for the standard appliance 400 V 3+N.

- Note for assembly 440 V - 3 phases without neutral.

DESCRIPTION	CODE	B-M-E 700,900	F-E 705,905	F-E 710,910	B-E9051	B-E9101	F-E 7 ONE CONTAINER	F-E 7 TWO CONTAINERS	SPE 710 MANUAL	CPE 7,9 ONE CONTAINER	CPE 7,9 TWO CONTAINERS	M-E 710	F-E 9 ONE CONTAINER	F-E 9 TWO CONTAINERS	SPE 91X MANUAL	M-E 910	SPE 91 MOTORISED	€
Ship kit 16A	19087491	1	1	2														-
Ship kit 16A with Energy Regulator	19089410				1	2												-
Ship kit 20A	19087492						1	2	1									-
Ship kit 20A with Energy Regulator	19087493									1	2	1						-
Ship kit 40A	19087494												1	2	1			-
Ship kit with Transformer	19057294															1	1	-
230 III - Conversion to 230 V three phase without neutral	(*)																	-
230 1N - Conversion to 230 V single phase	(*)																	-

(\*): Consult the existence of a version for this voltage



# Independent cooking

Gas cookers .....	095
Stockpot stoves .....	095
Fryers .....	096
Snack fryers .....	096
Fry tops .....	097
Salamanders .....	098
Grilling	
— Basque Grill .....	099
— Robotas .....	100

All gas cooking equipment should be fitted with gas governors:  
- LPG: 37 g/cm<sup>2</sup>  
- Natural Gas: 20 g/cm<sup>2</sup>



Specific equipment  
for non-modular  
cooking.



Access the website



## Gas cookers



### General characteristics

- Stamped stainless steel surface top.
- Double grill and nickel-plated burners.
- Dimensions of the double grill: 286 x 533mm.
- Open burners, one with 3,5kW and the other 6kW, safety valve and thermocouples.
- Controls with a protective support base and system to prevent water infiltration.
- Access to the components from the front.
- Gas oven option measuring 450x420x300mm with 5.2 tubular burner, pilot flame and thermocouple.
- Temperature controlled by thermostatic valve (110 – 310 °C).

SUPPLY	MODEL	GAS	CODE	BURNERS	OVEN	POWER (kW)	DIMENSIONS (WXDXH mm)	€
Gas cookers	CI-CG604T 2	LPG	19102772	2	-	9,5	400x650x290	-
		NG	19102806					
	CI-CG606T 4	LPG	19102674	4	-	19	600x650x290	-
		NG	19102805					
	CI-CG606O 4	LPG	19102642	4	1	19 + 5,2	600x650x850	-
		NG	19102804					

## Stockpot stoves



### General characteristics

- Double crown burner made of cast iron.
- Enamelled cast iron grill.
- Ignition pilot.
- Safety thermocouple.

SUPPLY	MODEL	GAS	CODE	BURNERS	CONSUMPTION (KCAL/H)	POWER (kW)	DIMENSIONS (WXDXH mm)	€
Stockpot stove	CI-HPG 1	LPG	19102935	1	11.700	13.6	590x590x400	-
		NG	19102956					

## Fryers



### General characteristics

- Well stamped in stainless steel integrated into the stainless steel surface top.
- Thermostatic temperature control between 60 and 200 °C.
- Safety thermostat.
- Gas models: automatic ignition of burners using electromagnetic valve with pilot and thermocouple.
- Electric models: swivelling heating element making it easier to clean inside the well.
- Lever tap to empty the well located in the control panel.
- Basket dimensions: 200 x 250 x 100 mm.
- Built-in well cover.
- Controls with a protective support base and system to prevent water infiltration.
- Standard power supply for electric versions 400V 3+N

SUPPLY	MODEL	GAS	CODE	TANKS X VOLUME	BASKETS	POWER (kW)	DIMENSIONS (WXDXH mm)	€
Gas fryers	CI-FG604T 18	LPG	19103128	1 x 8l	1	7	400x650x290	-
		NG	19103129					
	CI-FG606T 28	LPG	19103250	2 x 8l	2	14	600x650x290	-
		NG	19103251					
Electric fryers	CI-FE604T 18	-	19103252	1 x 8l	1	6	400x650x290	-
	CI-FE606T 28	-	19103253	2 x 8l	2	12	600x650x290	-

## Electric fryers



### General characteristics

- Control by thermostat (60 °C to 195 °C).
- Safety thermostat. Safety switch for assembly.
- Removable shielded heating elements in stainless steel.
- Pilot light for heating.
- DESKTOP MODEL:
  - Safety micro switch that cuts off operation in case of incorrect assembly of the assembly.
- PEDESTAL MODEL:
  - Pilot light for heating. Cold zone.
  - Removable shielded heating elements in stainless steel.
  - Lower cabinet.
  - Drainage cock.

MODELS	CODE	BASKETS	TANK CAPACITY (L)			ELECTRIC POWER (kW)	VOLTAGE	DIMENSIONS (mm)	€	
			TOTAL	OIL	COLD ZONE					
DESKTOP										
	FE-4	19004652	1	4		3,00	230 V - 1+N	175x485x270	-	
	FE-6	19004713	1	6		4,50	400 V - 3+N	265x485x270	-	
		19004709	1	6		4,50	230 V - 1+N	265x485x270	-	
	FE-8	19004728	1	8		6,00	400 V - 3+N	355x485x270	-	
		19004749	1	8		6,00	230 V - 1+N	355x485x270	-	
WITH PEDESTAL										
	FE-18	19005130	1	18	12	6	9,00	-	355x520x850	-
	FE-25	19005404	1	25	17	8	12,70	-	430x585x850	-

## Fry-tops



### General characteristics

- Models with flat, grooved or mixed stovetop (1/2 flat and 1/2 grooved).
- Electric models: Electric-heating models with embedded stainless steel heating elements and thermostat temperature control, from 50 to 310 °C.
- Gas: Stainless steel burner with pilot flame for ignition.
- Versions featuring galvanised carbon steel valve or safety valve with thermocouple.
- One type of grill offers two separate heating areas.
- Removable grease collection drawer.

SUPPLY	MODEL	GAS	CODE	Hz	PLATE		POWER (kW)	DIMENSIONS (W X D X H mm)	€	
					COOKING AREAS	SURFACE dm <sup>2</sup>				
<b>Control by thermostat (100 to 300°C)</b>										
	CI-FTG604T 1 S	LPG NG	19102967 19106482	50	1	S	20	7,5	400x650x290	-
	CI-FTG604T 1 R	LPG NG	19106483 19106484	50	1	R	20	7,5	400x650x290	-
	CI-FTG608T 2 S	LPG NG	19103041 19106537	50	2	S	30	15	800x650x290	-
	CI-FTG608T 2 R	LPG NG	19106538 19106539	50	2	R	30	15	800x650x290	-
	CI-FTG608T 2 SR	LPG NG	19106540 19106541	50	2	SR	30	15	800x650x290	-
<b>Models with max-min gas valve (only for mild steel plates)</b>										
	CI-FTG604T 1 V S	LPG NG	19103419 19106485	50	1	S	20	7,5	400x650x290	-
	CI-FTG604T 1 V R	LPG NG	19106534 19106536	50	1	R	20	7,5	400x650x290	-
	CI-FTG608T 2 V S	LPG NG	19103418 19106542	50	2	S	30	15	800x650x290	-
	CI-FTG608T 2 V R	LPG NG	19106543 19106544	50	2	R	30	15	800x650x290	-
	CI-FTG608T 2 V SR	LPG NG	19106546 19106547	50	2	SR	30	15	800x650x290	-
<b>Control by thermostat (100 to 300°C) and chromium hot-plate</b>										
	CI-FTG604T 1 C S	LPG NG	19106575 19106576	50	1	C S	20	7,5	400x650x290	-
	CI-FTG604T 1 C R	LPG NG	19106577 19106579	50	1	C R	20	7,5	400x650x290	-
	CI-FTG608T 2 C S	LPG NG	19106580 19106581	50	2	C S	30	15	800x650x290	-
	CI-FTG608T 2 C R	LPG NG	19106582 19106583	50	2	C R	30	15	800x650x290	-
	CI-FTG608T 2 C SR	LPG NG	19106584 19106585	50	2	C SR	30	15	800x650x290	-
<b>Control by thermostat</b>										
	CI-FTE604T 1 S	-	19103030	50/60	1	S	20	5	400x650x290	-
	CI-FTE604T 1 R	-	19106551	50/60	1	R	20	5	400x650x290	-
	CI-FTE608T 2 S	-	19103402	50/60	2	S	30	10	800x650x290	-
	CI-FTE608T 2 R	-	19106563	50/60	2	R	30	10	800x650x290	-
	CI-FTE608T 2 SR	-	19106574	50/60	2	SR	30	10	800x650x290	-
<b>Control by thermostat and chromium hot-plate</b>										
	CI-FTE604T 1 C S	-	19106586	50/60	1	C S	20	5	400x650x290	-
	CI-FTE604T 1 C R	-	19106587	50/60	1	C R	20	5	400x650x290	-
	CI-FTE608T 2 C S	-	19106588	50/60	2	C S	30	10	800x650x290	-
	CI-FTE608T 2 C R	-	19106589	50/60	2	C R	30	10	800x650x290	-
	CI-FTE608T 2 C SR	-	19106590	50/60	2	C SR	30	10	800x650x290	-

Gas frytops

Electric frytops

Finishes: S = Smooth ; R = Ribbed ; SR = 1/2 smooth + 1/2 ribbed ; C = 50 microns thickness chromium coated hot-plate.

## Salamanders



### Ultrarapid salamanders

- Perfect cooking uniformity, guaranteed by the redesigned deflectors and perfect positioning.
- 20 seconds to reach maximum temperature from ignition; max. 5 seconds already in operation.
- Removable chrome-plated steel juice collection trays and grids with athermic handles.
- Rounded corners and adjustable feet.
- Wall mounting possible.
- Redesigned control panel for maximum functionality.
- Insulated handle with bakelite spacer and improved shielding of external surfaces.
- Two independent cooking zones on the QSET60 model.
- The contact models contain a plate detection bar for automatic on and off switching.

MODEL	CODE	GRILL		VOLTAGE (kW)	POWER (kW)	DIMENSIONS	€
		COOKING ZONES	COOKING (mm)				
SEQ 60-4	19107720	2	600x350	380-415 3N~	4,0	600x480x525	-
Contact models*							
SEQ 60-4 T	19107717	2	600x350	380-415 3N~	4,0	600x480x525	-

\* Ultraspeed Contact Salamanders offer maximum performances thanks to infrared cooking generated by tungsten heaters and protected by a glass ceramic plate. Perfect for intensive use, meeting the highest speed and efficiency requirements, they are ideal for demanding and energy-conscious chefs.

### Classic salamanders

- AISI 304 Satin-finished stainless steel.
- Easy-to-clean Incoloy tilting heating elements in the upper movable deck.
- Drip trays and chrome-plated grids are removable, with heating resistant handle.
- Rounded corners.
- Adjustable feet.
- Possibility of fixing to the wall.
- The best usability with the redesigned control panel.
- Handle insulated by a Bakelite spacer and an enhanced shielding of the surfaces for high safety.
- Single zone compact salamander version SEC 40 or double cooking zone in SEC 60 models.



MODEL	CODE	GRILL		VOLTAGE (kW)	POWER (kW)	DIMENSIONS	€
		COOKING ZONES	COOKING (mm)				
SEC 40-0	19107712	1	400x350	220-240 1~	2	400x550x500	-
SEC 60-4	19107716	2	600x350	380-415 3N~	4	600x550x500	-

### Light salamanders

- Stainless Steel AISI 430.
- Movable cover with 90° welded corners.
- Plastic handle with phenolic base (bakelite)
- Tilting easy-to-clean heating elements.
- Sauce collection containers and removable chrome-plated steel grills
- Drip trays and chrome-plated grids removable for cleaning.
- Two independent cooking zones.



MODEL	CODE	GRILL		VOLTAGE (kW)	POWER (kW)	DIMENSIONS	€
		COOKING ZONES	COOKING (mm)				
SEL 60-4	19107719	2	600x350	400 2N~	4,0	600x450x500	-



### Accessories

Supports for wall-mounting salamanders

MODEL	CODE	€
SS-60	19036364	-

## Grilling | Basque Grill





- Base with cut-out at the bottom back to bridge any skirting board on the wall.
- Unit clad in stainless steel down to the floor.
- With 4 height-adjustable feet and 4 castors.
- Back cover to hide the guide system and give an easier-to-clean finish. Includes grill guide, system of counterweights and fixed top grill.
- Top vents for optimum temperature diffusion.
- Grill constructed in stainless steel.
- Cooking grill height-adjustable by crank at front, making it possible to cook at different intensities to achieve the perfect cooking point. Includes counterweight to soften the adjustment action.
- Grill with larger dimensions for greater versatility.
- Includes fat collection tray, easily removable without tools.
- The grill is tilted by 5°. This allows the fat to run along the grill by capillary motion to the fat collection tray. This prevents fat from falling onto the embers, which would cause flame-ups that alter the cooking of the food.
- Includes a second fixed grill at the top for temperature maintenance of the product.
- All the grills are dismantlable, to facilitate cleaning.

### General characteristics

- Offers precision cooking with natural charcoal. In addition, it can be used as a showcooking element for preparing dishes in front of the customer.
- Unit designed for installation against wall.
- Surface top manufactured in 3 mm thick AISI-310 stainless steel, with rounded edges for easy cleaning.
- Mouth of grill raised above the surface top to allow the grill to be brought as close as possible to the embers and funnel the outlet of heat, for greater efficiency.
- Inner floor of the grill protected by refractory brick to insulate and concentrate the heat and improve efficiency.
- Easy withdrawal of the ashes.
- Includes an ash collection drawer by grill.
- Each grill has a lower zone with door (without shelf or rack), designed for housing a charcoal trolley (optional) or another trolley of the premises.

### OPTIONAL ACCESSORY:

- Trolley for charcoal.
- Stainless steel drawer with reinforced upper part.
- With four wheels for easy movement.
- Designed for storing charcoal to feed the Basque grill mid-service more conveniently.
- Allows the charcoal to be stored in an external zone which does not affect the hygiene of the food handling areas.
- Dimensions: 370 x 380 x 536 mm.
- Interior capacity: 48 litres.

MODEL	CODE	GRILL DIMENSIONS (mm)	POWER IN CARBON EQUIVALENT (kW)	ELECTRICAL CONNECTION	ELECTRICAL POWER (kW)	DIMENSIONS (mm)	€
 BGF-1000	19048685	650 x 560	4,6	230 V 1+N	0,025	800 x 870 x 1.500	-
 BGF-2000	19058110	2 x 650 x 560	9,2	230 V 1+N	0,05	1.600 x 870 x 1.500	-

### Accessory: Trolley for charcoal

MODEL	CODE	CAPACITY (L)	DIMENSIONS (mm)	€
 CBGF	19048692	48	370 x 380 x 536	-

## Grilling | Robotas



### CENTRAL UNIT MODEL

- Robata on stainless steel unit for independent use.
- Can be used from both sides.
- 150 mm free work-surface on both sides of the robata.
- Equipped with 4 wheels (two with brake).
- Includes folding frame on one side to accommodate two GN 1/9 trays.
- Comes with two large, multi-purpose drawers with reinforced guides.
- Superstructure in stainless steel profile with 3 different levels.
- 82 mm for cooking
- 239 mm for slow cooking of the core
- 396 mm to preheat or maintain the temperature of the product.
- Includes brochette rests, distance adjustable to hold brochettes of different lengths.
- The superstructure is dismantlable, without the need for tools, to allow cooking at barbecue level.

### TABLETOP MODELS



- Robotas designed for installation onto furniture of the premises.
- Height of surface top of the supporting unit: 570 mm, to allow a working height of 900 mm.
- If positioned against a wall (whether of the building or a perimeter of the surface top), leave 5 cm between the Robata and the ends of the wall to allow heat dispersal.

### ACCESSORIES:

- Poker for keeping the embers alive.
- Stainless steel mesh grill for cooking food without the use of brochettes
- Stainless steel grill for cooking and marking meat.

### General characteristics

- In Japanese cooking, robotayaki refers to food prepared in front of the customers, in which the ingredients, normally on brochettes, are grilled slowly over charcoal embers, in a way which is similar to a barbecue.
- Surface top manufactured in 2 mm thick AISI-304 stainless steel, with rounded edges for easy cleaning.
- Raised edge to allow cooking at barbecue level, with no superstructure.
- Thick base in refractory steel to bear the charcoal, with perforations to improve air circulation and provide better combustion.
- Easy withdrawal of the ashes.
- Tank insulated with 30 mm of rock wool to prevent temperature loss and improve the ergonomics of your work.
- Outer body separated from the tank, in stainless steel, with perforations to allow external air flow that improves heat dissipation.
- Includes 1 or 2 drawers for ash collection.

MODEL	CODE	GRILL DIMENSIONS (mm)	LEVELS OF THE SUPERSTRUCTURE	POWER IN CARBON EQUIVALENT (kW)	DIMENSIONS (mm)	€
 RGF-060	19048686	355 x 216	3	1	590 x 450 x 330	-
 RGF-100	19048688	800 x 216	3	2	1.107 x 450 x 330	-
 RGF-1000	19048689	800 x 216	3	2	1.107 x 850 x 900	-

### Accessories

DESCRIPTION	CODE	€
Attacher	19048789	-
Stainless steel mesh grill	19048690	-
Stainless steel grill for marking meat	19048691	-



# Large capacity cooking equipment

## Boiling pans

Fixed cylindrical boiling pans .....	103
Fixed cylindrical boiling pans with mixer.....	105
Tilting cylindrical boiling pans.....	107
Fixed rectangular boiling pans .....	109
Fixed Gastronorm rectangular boiling pans.....	111
Automatic tilting rectangular boiling pans with mixer and PLC monitor .....	113

## Tilting bratt pans

Motorised tilting bratt pans .....	115
Automatic tilting bratt pans on frame.....	117

Automatic cookers.....	119
------------------------	-----

Large capacity cooking equipment.



Access the website



# Fixed cylindrical boiling pans



## General Characteristics

- Boiling pan with cylindrical structure and recipient, suitable for placement in transit areas with reduced dimensions where appliances with sharp edges and surfaces may cause ergonomic and movement problems, allowing it to be used comfortably from different angles.
- Well with AISI-316 stainless steel bottom with a thickness of between 20/10 and 40/10, suitable for products that are particularly acidic.
- AISI-304 stainless steel walls with a thickness of between 20/10 and 40/10. Double wall in indirect versions.
- AISI-304 stainless steel cover with a thickness of 15/10, balance springs and an athermic handle.
- Supporting structure in AISI-304 stainless steel.
- Satin AISI-304 exterior coating.
- Adjustable stainless-steel feet.
- Heat insulation guaranteed by high-density ceramic fibre plates.
- Tank drainage hole with a removable filter.
- Front drainage tap with an insulated athermic handle.
- Gauge for controlling pressure inside the double wall.
- Manual valve for emptying air in order to depressurise the chamber during heating.
- Water is added to the well through a tap with a moveable outlet.
- Heating:
  - GAS:
    - High-performance stainless-steel tubular burners.
    - Manual piezoelectric ignition and pilot flame.
    - Smoke extraction grille.
    - Tap with safety valve and thermocouples (direct version).
  - INDIRECT ELECTRIC:
    - Heated by elements immersed in Incoloy alloy with adjustable power via an energy variator.
    - Safety thermostat which ensures that the machine does not operate in the event of

- overheating or insufficient water.
- Water control in the double wall with maximum/minimum taps and an automatic water load option.
- Standard operating voltage of 400V-3N-50Hz
- INDIRECT STEAM:
  - Heated by steam (from the user's connection) through a valve that allows steam to be added gradually into the liner.
  - Indirect heating equipment: pressure control in the double wall through a safety valve set to 0.5 bar, a manual depression valve and a gauge.
  - The pressure or autoclave versions allow the cooking cycles to speed up through the day. They are fitted with a silicone rubber airtight joint and clamps to hermetically close it and a safety valve set to 0.05 bar.

MODEL	CODE	POWER (kW)	CAPACITY (l)	DIMENSIONS (mm)	€
CYLINDRICAL GAS BOILING PANS					
<b>Directly heated gas</b>					
MCG-300	19003043	39	300	1290x1391x950	-
MCG-500	19001445	55	500	1390x1479x1020	-
<b>Directly pressure heated gas</b>					
MCG-300 A	19003041	39	300	1290x1391x950	-
MCG-500 A	19001446	55	500	1390x1479x1020	-
<b>Indirectly heated gas</b>					
MCIG-200	19003078	39	200	1090x1195x900	-
MCIG-300	19001448	48	300	1290x1391x950	-
MCIG-500	19003079	55	500	1390x1479x1020	-
<b>Indirectly pressure heated gas</b>					
MCIG-200 A	19001447	39	200	1090x1195x900	-
MCIG-300 A	19001449	48	300	1290x1391x950	-
MCIG-500 A	19001450	55	500	1390x1479x1020	-
ELECTRIC CYLINDRICAL BOILING PANS					
<b>Indirectly heated electric</b>					
MCIE-200	19003076	24	200	1060x1000x900	-
MCIE-300	19001443	36	300	1260x1200x950	-
MCIE-500	19003077	48	500	1360x1300x1000	-
<b>Indirectly pressure heated electric</b>					
MCIE-200 A	19001442	24	200	1060x1000x900	-
MCIE-300 A	19003040	36	300	1260x1200x950	-
MCIE-500 A	19001444	48	500	1360x1300x1000	-

## Options

	MODEL	CODE	DESCRIPTION	€
	GF-M	19084528	Drainage tap with 2" AISI-316 clamp connection	-
	VM-M	19084529	2.5" AISI-304 butterfly valve ISO DN50	-
	TD-M	19084539	Flexible tube with shower	-
	DA-M	19084530	Device for automatic drainage of air from double wall	-
*	CENA-M	19084531	Electronic control of water load in double wall	-
	CECA-M	19084532	Electronic control of water load in the well with display and volumetric probe	-

\* Highly recommended

## Accessories

	MODEL	CODE	DESCRIPTION	€
	CM-2200	19084524	Kit 2 1/2 baskets for 200-litre boiling pan	-
	CM-2300	19084525	Kit 2 1/2 baskets for 300-litre boiling pan	-
	CM-4300	19084526	Kit 4 1/4 baskets for 300-litre boiling pan	-
	CM-4500	19084527	Kit 4 1/4 baskets for 500-litre boiling pan	-







# Fixed cylindrical boiling pans with mixer



## General Characteristics

- Well with AISI-316 stainless steel bottom with a thickness of between 20/10 and 40/10, suitable for products that are particularly acidic.
- AISI-304 stainless steel cooking well walls with thickness of between 20/10 and 25/10.
- Tank drainage hole with a removable filter.
- 2" front drainage tap with insulated athermic handle.
- Double wall with AISI-304 stainless steel bottom and walls.
- AISI-304 stainless steel cover with a thickness of 15/10, fitted with a chromed steel zip with preloading springs and an athermic handle.
- Gauge for controlling pressure inside the double wall.
- Manual air escape valve for depressurising the air produced in the double wall during the heating process.
- 2 versions:
  - . Normal version: safety valve with a spring set to 0.5 bar.
  - . Autoclave version: silicone rubber joint restraint, clamps to hermetically seal the cover and a safety valve set to 0.05 bar.
- Stainless steel supporting structure with a thickness of 30/10 fitted on steel feet with an adjustable height.
- AISI-304 satin stainless steel external walls with a thickness of 10/10.
- AISI-304 stainless steel satin shelf with a thickness of 15/10.
- Removable inner coating to enable easy inspection of internal parts.
- Heat insulation guaranteed by high-density ceramic fibre plates.
- Mixing system:
  - . AISI-316 stainless steel mixer with an adjustable rotation speed of between 7 and 28 g/m with a force of up to 386 N-m
  - . Possibility to reverse the operating direction with the electronic switch.
  - . Removable mixer to ease cleaning and product extraction.
  - . Mixer fitted with stainless steel radial arms and Teflon ceramic blades.
- Heating:
  - . Indirect electric with double wall.
  - Heated by heating elements immersed in Incoloy alloy with adjustable power thanks to an energy variator.
- Thermoregulation and electronic time delay of the temperature and process time.
- Heating elements fitted with a safety thermostat which ensures that the machine does not operate in the event of overheating or insufficient water.
- Water control in the double wall with maximum/minimum taps and an automatic water load option with probes.
- Pressure control of the double wall through a pressure switch and a safety valve set to 0.5 bar, a depression valve and a gauge.
- Standard operating voltage of 400V-3N-50Hz.
- . Indirect steam with double wall.
- Heated by steam (from the user's connection) with a counter-pressure valve that allows steam to be added gradually to the double wall.
- Pressure control in the double wall through the safety valve set to 0.5 bar, depression valve and gauge.
- Standard operating voltage of 400V-3N-50Hz.

MODEL	CODE	POWER (kW)	CAPACITY (l)	DIMENSIONS (mm)	€
ELECTRIC CYLINDRICAL BOILING PANS WITH MIXER					
<b>Indirectly heated electric</b>					
MCIE-200 M	19084225	24.37	200	1120x1000x1000	-
MCIE-300 M	19084227	36.37	300	1320x1200x950	-
MCIE-500 M	19084231	48.37	500	1420x1300x1050	-
<b>Indirectly pressure heated electric</b>					
MCIE-200 A M	19084226	24.37	200	1120x1000x1000	-
MCIE-300 A M	19084229	36.37	300	1320x1200x950	-
MCIE-500 A M	19084232	48.37	500	1420x1300x1050	-

	MODEL	CODE	DESCRIPTION	€
	GF-M	19084528	Drainage tap with 2" AISI-316 clamp connection	-
	VM-M	19084529	2.5" AISI-304 butterfly valve ISO DN50	-
	TD-M	19084539	Flexible tube with shower	-
	DA-M	19084530	Device for automatic drainage of air from double wall	-
* 	CENA-M	19084531	Electronic control of water load in double wall	-
	CECA-M	19084532	Electronic control of water load in the well with display and volumetric probe	-

\* Highly recommended

# Tilting cylindrical boiling pans









## General Characteristics

- Automatic tilting boiling pan with lateral loading columns. The tilting of the well eases the transfer of solid foods. This is the quickest and easiest way of cooking high quantities.
- Cooking well with an AISI-316 stainless steel bottom with a thickness of between 20/10 and 40/10, and an AISI-304 stainless steel double wall with thicknesses of between 20/10 and 25/10.
- AISI-304 stainless steel cover with a thickness of 15/10, balance springs, an athermic handle and an insulated cover available upon request.
- Gauge for controlling pressure inside the double wall.
- Manual air escape valve for depressurising the air produced in the double wall during the heating process.
- Adjustable chromed bronze mixer with hot and cold water.
- Weight safety valve set to 0.5 bar.
- Stainless steel supporting structure with a thickness of 30/10 fitted on a frame.
- Fine satin AISI-304 exterior. Thermal insulation guaranteed by high-density ceramic fibre panels.
- Automatic tilting system via a hydraulic cylinder.
- Automatic shut-off system when inclined.
- Heating:
  - GAS:
    - High-performance stainless-steel tubular burners.
    - Manual piezoelectric ignition and pilot flame.
  - INDIRECT ELECTRIC:
    - Heated by heating elements immersed in Incoloy alloy with adjustable power via an energy variator.
- Smoke extraction grille.
- Tap with safety valve and thermocouples (direct version).

- Safety thermostat which ensures that the machine does not operate in the event of overheating or insufficient water.
- Water control in the double wall with maximum/minimum taps and an automatic water load option.
- Standard operating voltage of 400V-3N-50Hz
- INDIRECT STEAM:
  - Heated by steam (from the user's connection) through a valve that allows steam to be added gradually into the liner.
  - Indirectly heated equipment: pressure control in the double wall through the safety valve set to 0.5 bar, manual depression valve and gauge.





MODEL	CODE	POWER (kW)	CAPACITY (l)	DIMENSIONS (mm)	€
<b>GAS TILTING CYLINDRICAL BOILING PANS</b>					
<b>Directly heated gas</b>					
MCBG-100	19001283	26.4	100	1600x970x1050	-
MCBG-150	19001227	26.4	150	1600x970x1050	-
MCBG-200	19001284	39.4	200	1750x1135x1050	-
MCBG-300	19001228	39.4	300	1960x1325x1300	-
MCBG-500	19001285	55.4	500	2050x1475x1300	-
<b>Indirectly heated gas</b>					
MCBIG-100	19001229	26.4	100	1600x970x1050	-
MCBIG-150	19001286	26.4	150	1600x970x1050	-
MCBIG-200	19001230	39.4	200	1750x1135x1050	-
MCBIG-300	19001287	48.4	300	1960x1325x1300	-
MCBIG-500	19001231	55.4	500	2050x1475x1300	-
<b>ELECTRIC TILTING CYLINDRICAL BOILING PANS</b>					
<b>Indirectly heated steam</b>					
MCBIE-100	19001278	12.4	100	1600x885x1050	-
MCBIE-150	19003052	16.4	150	1600x885x1050	-
MCBIE-200	19001280	24.4	200	1750x1035x1050	-
MCBIE-300	19003053	36.4	300	1950x1230x1300	-
MCBIE-500	19001282	48.4	500	2050x1370x1300	-
<b>STEAM TILTING CYLINDRICAL BOILING PANS</b>					
<b>Indirectly heated steam</b>					
MCBIV-100	19003072	0.4	100	1600x885x1050	-
MCBIV-150	19001289	0.4	150	1600x885x1050	-
MCBIV-200	19003073	0.4	200	1750x1035x1050	-
MCBIV-300	19001291	0.4	300	1950x1230x1300	-
MCBIV-500	19003074	0.4	500	2050x1370x1300	-

## Options

	MODEL	CODE	DESCRIPTION	€
	GF-M	19084528	Drainage tap with 2" AISI-316 clamp connection	-
	VM-M	19084529	2.5" AISI-304 butterfly valve ISO DN50	-
	TD-M	19084539	Flexible tube with shower	-
	DA-M	19084530	Device for automatic drainage of air from double wall	-
* 	CENA-M	19084531	Electronic control of water load in double wall	-
	CECA-M	19084532	Electronic control of water load in the well with display and volumetric probe	-

\* Highly recommended

## Accessories

	MODEL	CODE	DESCRIPTION	€
	FBM-150	19084533	Drainage filter nozzle for 100-150-litre boiling pan	-
	FBM-200	19084534	Drainage filter nozzle for 200-litre boiling pan	-
	FBM-300	19084535	Drainage filter nozzle for 300-litre boiling pan	-
	FBM-500	19084536	Drainage filter nozzle for 500-litre boiling pan	-

# Fixed rectangular boiling pans



## General Characteristics

- Rectangular boiling pan with a cylindrical well. Can be assembled on its own or with other machines. Thanks to its rigidity and functionality, it is suitable for prolonged and continuous use.
- Cooking well with an AISI-316 stainless steel bottom with a thickness of between 20/10 and 40/10, and AISI-304 stainless steel walls with thicknesses of between 20/10 and 25/10.
- Tank drainage hole with a removable filter.
- Front drainage tap with insulated athermic handle.
- AISI-304 stainless steel cover with a thickness of 15/10, fitted with a chromed steel zip with preloading springs and an athermic handle.
- Gauge for controlling pressure inside the double wall.
- Manual air escape valve for depressurising the air produced in the double wall during the heating process.
- 2 versions:
  - Normal version: spring and weight safety valve (depending on the capacity of the machine) set to 0.5 bar.

- Autoclave version: silicone rubber joint restraint, clamps to hermetically seal the cover. Safety valve set to 0.05 bar.
- Stainless steel supporting structure with a thickness of 30/10 fitted on steel feet with an adjustable height.
- AISI-304 satin stainless steel external walls with a thickness of 10/10.
- AISI-304 stainless steel satin shelf with a thickness of 15/10.

- Heating:

GAS:

- High-performance stainless-steel tubular burners.
- Manual piezoelectric ignition and pilot flame.
- Smoke extraction grille.
- Tap with safety valve and thermocouples (direct version).

INDIRECT ELECTRIC:

- Heated by heating elements immersed in Incoloy alloy with adjustable power via an energy variator.

- Safety thermostat which ensures that the machine does not operate in the event of overheating or insufficient water.
- Water control in the double wall with maximum/minimum taps and an automatic water load option.
- Standard operating voltage of 400V-3N-50Hz

INDIRECT STEAM:

- Heated by steam (from the user's connection) through a valve that allows steam to be added gradually into the liner.
- Indirect heating equipment: pressure control in the double wall through a safety valve set to 0.5 bar, a manual depression valve and a gauge.

MODEL	CODE	POWER (kW)	CAPACITY (l)	DIMENSIONS (mm)	€
<b>GAS RECTANGULAR BOILING PANS</b>					
<b>Directly heated gas</b>					
MRG-300	19001273	39	300	1200x1270x900	-
MRG-500	19001418	55	500	1300x1400x1000	-
<b>Directly pressure heated gas</b>					
MRG-300 A	19003031	39	300	1200x1270x900	-
MRG-500 A	19001419	55	500	1300x1400x1000	-
<b>Indirectly heated gas</b>					
MRIG-200	19003091	39	200	1000x1150x850	-
MRIG-300	19001421	48	300	1200x1270x900	-
MRIG-500	19001272	55	500	1300x1400x1000	-
<b>Indirectly pressure heated gas</b>					
MRIG-200 A	19001420	39	200	1000x1150x850	-
MRIG-300 A	19003045	48	300	1200x1270x900	-
MRIG-500 A	19001422	55	500	1300x1400x1000	-
<b>ELECTRIC RECTANGULAR BOILING PANS</b>					
<b>Indirectly heated electric</b>					
MRIE-200	19001414	24	200	1000x1150x850	-
MRIE-300	19003082	36	300	1200x1270x900	-
MRIE-500	19001416	48	500	1300x1400x1000	-
<b>Indirectly pressure heated electric</b>					
MRIE-200 A	19001274	24	200	1000x1150x850	-
MRIE-300 A	19001415	36	300	1200x1270x900	-
MRIE-500 A	19001275	48	500	1300x1400x1000	-
<b>STEAM RECTANGULAR BOILING PANS</b>					
<b>Indirectly heated steam</b>					
MRIV-200	19001424	-	200	1000x1150x850	-
MRIV-300	19003087	-	300	1200x1270x900	-
MRIV-500	19001426	-	500	1300x1400x1000	-
<b>Indirectly pressure heated steam</b>					
MRIV-200 A	19003089	-	200	1000x1150x850	-
MRIV-300 A	19001425	-	300	1200x1270x900	-
MRIV-500 A	19003090	-	500	1300x1400x1000	-

## Options

	MODEL	CODE	DESCRIPTION	€
	GF-M	19084528	Drainage tap with 2" AISI-316 clamp connection	-
	VM-M	19084529	2.5" AISI-304 butterfly valve ISO DN50	-
	TD-M	19084539	Flexible tube with shower	-
	DA-M	19084530	Device for automatic drainage of air from double wall	-
*	CENA-M	19084531	Electronic control of water load in double wall	-
	CECA-M	19084532	Electronic control of water load in the well with display and volumetric probe	-

\* Highly recommended

## Accessories

	MODEL	CODE	DESCRIPTION	€
	CM-2200	19084524	Kit 2 1/2 baskets for 200-litre boiling pan	-
	CM-2300	19084525	Kit 2 1/2 baskets for 300-litre boiling pan	-
	CM-4300	19084526	Kit 4 1/4 baskets for 300-litre boiling pan	-
	CM-4500	19084527	Kit 4 1/4 baskets for 500-litre boiling pan	-



# Fixed Gastronorm rectangular boiling pans



## General Characteristics







- Rectangular boiling pan with a Gastronorm rectangular well. Can be assembled on its own or with other machines. Due to its rigidity and functionality, it is suitable for prolonged and continuous use.
- Cooking well with an AISI-316 stainless steel bottom with a thickness of 25/10 and AISI-304 stainless steel walls with thicknesses of between 20/10 and 25/10.
- Front drainage tap with an insulated athermic handle.
- AISI-304 stainless steel cover with a thickness of 15/10, balance springs, an athermic handle and an insulated cover available upon request.
- Gauge for controlling pressure inside the double wall.
- Manual air escape valve for depressurising the air produced in the double wall during the heating process.
- Adjustable chromed bronze mixer with hot and cold water.
- Weight safety valve set to 0.5 bar.
- With a stainless steel supporting structure.
- Equipped with stainless steel support feet with an adjustable height and a manually emptied liner filter.
- AISI-304 exterior coating. Fine satin. Heat insulation guaranteed by high-density ceramic fibre plates.
- Heating:
  - GAS:
    - High-performance stainless-steel tubular burners.
    - Manual piezoelectric ignition and pilot flame.
    - Smoke extraction grille.
    - Tap with safety valve and thermocouples (direct version).
  - Indirect electric:
    - Heated by heating elements immersed in Incoloy alloy with adjustable power via an energy variator.
- Safety thermostat which ensures that the machine does not operate in the event of overheating or insufficient water.
- Water control in the double wall with maximum/minimum taps and an automatic water load option.
- Standard operating voltage of 400V-3N-50Hz

### INDIRECT STEAM:

- Heated by steam (from the user's connection) through a valve that allows steam to be added gradually into the liner.
- Indirect heating equipment: pressure control in the double wall through a safety valve set to 0.5 bar, a manual depression valve and a gauge.

MODEL	CODE	POWER (kW)	CAPACITY (l)	DIMENSIONS (mm)	€
<b>GAS GASTRONORM RECTANGULAR BOILING PANS</b>					
<b>Directly heated gas</b>					
MGNG-280	19084264	35	280	1400x900x850	-
<b>Indirectly heated gas</b>					
MGNIG-180	19001394	29	180	1000x900x850	-
MGNIG-280	19003083	35	280	1400x900x850	-
MGNIG-400	19003084	45	400	2000x900x850	-
<b>ELECTRIC GASTRONORM RECTANGULAR BOILING PANS</b>					
<b>Indirectly heated electric</b>					
MGNIE-180	19003046	18	180	1000x900x850	-
MGNIE-280	19001312	24	280	1400x900x850	-
MGNIE-400	19001393	36	400	2000x900x850	-
<b>STEAM GASTRONORM RECTANGULAR BOILING PANS</b>					
<b>Indirectly heated steam</b>					
MGNIV-180	19001396	0.05	180	1000x900x850	-
MGNIV-280	19003049	0.05	280	1400x900x850	-
MGNIV-400	19003050	0.05	400	2000x900x850	-

## Options

	MODEL	CODE	DESCRIPTION	€
	GF-M	19084528	Drainage tap with 2" AISI-316 clamp connection	-
	VM-M	19084529	2.5" AISI-304 butterfly valve ISO DN50	-
	TD-M	19084539	Flexible tube with shower	-
	DA-M	19084530	Device for automatic drainage of air from double wall	-
* 	CENA-M	19084531	Electronic control of water load in double wall	-
	CECA-M	19084532	Electronic control of water load in the well with display and volumetric probe	-

\* Highly recommended

# Automatic tilting rectangular boiling pans with mixer and PLC monitor



## General Characteristics

- AISI-316 lucid stainless steel recipient bottom, suitable for products that are particularly acidic, with a thickness of between 20/10 and 40/10.
- AISI-304 stainless steel cooking well walls with thickness of between 20/10 and 25/10.
- Double wall with AISI-304 stainless steel bottom and walls.
- Tank drainage hole with removable filter (optional).
- Front drainage tap with insulated athermic handle (optional).
- AISI-304 stainless steel cover with a thickness of 15/10, fitted with a steel zip with preloading springs and an athermic handle.
- Gauge for controlling pressure inside the double wall.
- Manual air escape valve for depressurising the air produced in the double wall during the heating process.
- Adjustable chromed bronze mixer with hot and cold water.
- Weight safety valve set to 0.5 bar.
- Stainless steel supporting structure with a thickness of 40/10 fitted on steel feet with an adjustable height and a clamp for attaching it to the floor.
- AISI-304 satin stainless steel external walls with a thickness of 10/10.
- AISI-304 stainless steel satin shelf with a thickness of 15/10.
- AISI-316 stainless steel removable mixer with an adjustable rotation speed of between 7 and 28 g/m with a force of up to 386 N·m.
- Possibility to reverse the operating direction with the electronic switch.
- Stainless steel radial arms and Teflon ceramic scraping blades.
- PLC monitor:
  - . Allows up to 100 modifiable cooking programmes that can be managed and personalised, even during cooking.
  - . Fitted with a touch screen and manual controls for operation, water load, inclination and movement of the mixer.
  - . Fitted with acoustic warning message indicators (yellow) for correct functioning or alarms (red) in case of incorrect functioning.
  - . All of the settings are customisable and can be viewed and modified even during cooking (name, wait, water load, times, temperatures, probes, mixing speed, time, etc.).
- Heating:
  - . Indirectly heated gas:
    - Ignited with a manual piezoelectric and pilot flame.
    - Heated by tubular boilers and high-performance AISI-304 stainless steel.
    - Smoke extraction grille.
    - Set of nozzles for different types of gas.
    - Water level control in the double wall with maximum/minimum taps and an automatic water load option.
    - Pressure control of the double wall through the safety valve set to 0.5 bar, depression valve and gauge.
  - . Indirectly heated electric:
    - Heated by a set of electric heating elements.
    - Safety thermostat which ensures that the machine does not operate in the event of overheating or insufficient water.
    - Temperature control (50 - 120 °C).
  - . Indirectly heated steam:
    - Heated by steam (from the user's connection) with a counter-pressure valve that allows steam to be added gradually to the double wall.
    - Pressure control in the double wall through the safety valve set to 0.5 bar, depression valve and gauge.

MODEL	CODE	POWER (kW)	CAPACITY (l)	DIMENSIONS (mm)	€
<b>Indirectly heated gas</b>					
MRBIG-200 M	19084239	35.75	200	1674x1450x1140	-
MRBIG-300 M	19084240	35.75	300	1874x1650x1140	-
MRBIG-500 M	19084241	42.75	500	1976x1835x1140	-
<b>Indirectly heated electric</b>					
MRBIE-200 M	19084242	24.75	200	1674x1450x1140	-
MRBIE-300 M	19084243	36.75	300	1874x1650x1140	-
MRBIE-500 M	19084244	48.75	500	1976x1835x1140	-
<b>Indirectly heated steam</b>					
MRBIV-200 M	19084245	0.75	200	1674x1450x1140	-
MRBIV-300 M	19084246	0.75	300	1874x1650x1140	-
MRBIV-500 M	19084247	0.75	500	1976x1835x1140	-

## Options

	MODEL	CODE	DESCRIPTION	€
	GF-M	19084528	Drainage tap with 2" AISI-316 clamp connection	-
	VM-M	19084529	2.5" AISI-304 butterfly valve ISO DN50	-
	TD-M	19084539	Flexible tube with shower	-
	DA-M	19084530	Device for automatic drainage of air from double wall	-
*	CENA-M	19084531	Electronic control of water load in double wall	-
	CECA-M	19084532	Electronic control of water load in the well with display and volumetric probe	-

\* Highly recommended

## Accessories

	MODEL	CODE	DESCRIPTION	€
	FBM-150	19084533	Drainage filter nozzle for 100-150-litre boiling pan	-
	FBM-200	19084534	Drainage filter nozzle for 200-litre boiling pan	-
	FBM-300	19084535	Drainage filter nozzle for 300-litre boiling pan	-
	FBM-500	19084536	Drainage filter nozzle for 500-litre boiling pan	-

# Motorised tilting bratt pans



## General features

- Cooking chamber walls made from AISI 304 stainless steel.
- Bottom made from 10 mm thick AISI 304 stainless steel Option: 12 mm thick bottom made from composite (9 mm iron + 3 mm steel).
- Cooking chamber with non-stick finish and ceramic microspheres.
- Water can be added into the chamber using a single hole tap.
- 10/10 thick AISI 304 stainless steel lid, with chrome plated rack and preloaded spring and stainless steel handle.
- 20/10 thick stainless steel supporting structure, mounted on adjustable steel feet for levelling.
- 10/10 thick satin-finished AISI 304 stainless steel external walls.
- 20/10 thick satin-finished AISI 304 stainless steel shelf.
- Automatic motorised tilting - Includes a manual tilting system in the event of a fault.
- Automatic shutdown in the event of system failure.
- Heating:
  - DIRECT GAS:**
    - Manual Piezoelectric ignition and pilot flame.
    - Heating via tube and high performance AISI 304 stainless steel burners.
    - Smoke extraction grille.
    - Set of nozzles for different types of gas.
    - Safety thermostat
    - Tap with safety valve and thermocouple.
  - DIRECT ELECTRIC:**
    - Temperature regulated between 100 °C and 300 °C
    - Heating via a set of electric elements.
    - Safety thermostat for elements that prevents overheating.
    - Temperature control (50 °C - 260 °C).
    - Standard supply voltage 400 V 3N 50/60 Hz.

MODEL	CODE	POWER (kW)	CAPACITY (l)	DIMENSIONS (mm)	€
<b>Direct gas heating</b>					
SBG-150 M	19072688	33,01	150	1200x900x850	-
SBG-200 M	19079430	44,01	200	1600X900X850	-
<b>Direct electric heating</b>					
SBE-150 M	19072695	15,1	150	1200x900x850	-
SBE-200 M	19085076	20,1	200	1600X900X850	-

## Options

CODE	MODEL	DESCRIPTION	€
*	COMPOUND	12 mm composite bottom (9mm iron + 3 mm steel) for 150 L pans.	-
*	COMPOUND	12 mm composite bottom (9mm iron + 3 mm steel) for 200 L pans.	-

(\*) Check version.

# Automatic tilting bratt pans on frame



## General features

- Base and walls of cooking chamber made from AISI 304 stainless steel:
- SBGA and SBEA models: bottom made from 10 mm thick AISI 316 stainless steel Option: 12 mm thick composite (9 mm iron + 3 mm steel).
- SBGAX and SBEAX models: bottom made from 15 mm thick AISI 316 stainless steel Option: 15 mm thick composite (12mm iron + 3mm steel).
- Cooking chamber with non-stick finish and ceramic microspheres.
- Water can be added into the chamber via a single tap point.
- 10/10 thick AISI 304 stainless steel lid, with chrome plated rack and preloaded spring and stainless steel handle.
- Supporting structure made from 40/10 thick stainless steel, mounted on adjustable steel feet for levelling.
- 10/10 thick satin-finished AISI 304 stainless steel external walls.
- 15/10 thick satin-finished AISI 304 stainless steel shelf.
- Automatic tilting with hydraulic drive on the front axle
- Automatic shutdown in the event of system failure.
- Heating system:
  - DIRECT GAS:**
    - Manual or electric Piezo electric ignition and pilot flame (SBGAX and SBEAX versions).
    - Heating via tube and high performance AISI 304 stainless steel burners.
  - Smoke extraction grille.
  - Set of nozzles for different types of gas.
  - Safety thermostat.
- Tap with safety valve and thermocouple.
- Temperature regulated between 100 °C and 250°C
- DIRECT ELECTRIC:**
  - Heating via a set of electric elements.
  - Safety thermostat for elements that prevents overheating or inadequate heat levels.
  - Temperature control (100°C - 250°C).
  - Standard supply voltage 400 V 3N 50/60 Hz.

MODEL	CODE	POWER (kW)	CAPACITY (l)	DIMENSIONS (mm)	€
<b>Direct gas heating</b>					
SBGA-150	19085078	33,04	150	1600x905x930	-
SBGA-210	19085080	44,04	200	2000x905x930	-
SBGAX-300	19085082	33,75	300	1420x1840x1350	-
SBGAX-400	19085083	33,75	400	1420x1840x1350	-
<b>Direct electric heating</b>					
SBEA-150	19085085	15,4	150	1600x905x930	-
SBEA-210	19085087	20,4	200	2000x905x930	-
SBEAX-300	19085088	28,75	300	1420x1840x1350	-
SBEAX-400	19085089	28,75	400	1420x1840x1350	-

## Options

CODE	MODEL	DESCRIPTION	€
*	COMPOUND	12 mm composite bottom (9mm iron + 3 mm steel) for 130 and 150 L pans.	-
*	COMPOUND	12 mm composite bottom (9mm iron + 3 mm steel) for 165, 200 and 210 L pans.	-
*	COMPOUND	15 mm composite bottom (12mm iron + 3mm steel) for 300 and 400 L pans.	-
19084539	TD-M	Flexible hose with shower	-

(\*) Check version.



# Automatic cookers



MODEL	CODE	POWER (kW)	TANKS		DIMENSIONS (mm)	€
			QUANTITY	CAPACITY (l)		
<b>Directly heated gas</b>						
CAG-1132	19084248	24,1	1	132	900x900x850	-
CAG-1223	19084249	39,1	1	223	1250x1000x925	-
CAG-2132	19084254	48,2	2	132+132	1800x900x850	-
CAG-2223	19084255	78,2	2	223+223	2500x1000x925	-
<b>Directly heated electric</b>						
CAE-1132	19084250	13,7	1	132	900x900x850	-
CAE-1223	19084251	25,0	1	223	1250x1000x925	-
CAE-2132	19084256	27,4	2	132+132	1800x900x850	-
CAE-2223	19084257	50,0	2	223+223	2500x1000x925	-
<b>Indirectly heated steam</b>						
CAIV-1132	19084252	0,1	1	132	900x900x850	-
CAIV-1223	19084253	0,1	1	223	1250x1000x925	-
CAIV-2132	19084258	0,2	2	132+132	1800x900x850	-
CAIV-2223	19084260	0,2	2	223+223	2500x1000x925	-

## General Characteristics

- Well fully made from AISI-316 satin stainless steel.
  - AISI-316 satin stainless steel baskets.
  - Overflow and tap for output and drainage.
  - AISI-304 stainless steel cover with a thickness of 15/10, fitted with a steel zip with preloading springs and an athermic handle.
  - Gauge for controlling pressure inside the double wall.
  - Manual air escape valve for depressurising the air produced in the double wall during the heating process.
  - Adjustable chromed bronze mixer with hot and cold water.
  - Weight safety valve set to 0.5 bar.
  - Stainless steel supporting structure with a thickness of 20/10 fitted on stainless steel feet that can be adjusted between 150 mm and 180 mm.
  - AISI-304 satin stainless steel external walls with a thickness of 10/10.
  - AISI-304 stainless steel satin shelf with a thickness of 15/10.
  - Fitted with digital controls with 3 displays showing 4 numbers, enabling the temperature to be adjusted between 20 °C and 110 °C.
  - Possibility to change amount of time the basket is submerged, with a minimum interval of 1 second.
  - Acoustic illuminated indicator to inform of the end of the cooking cycle.
  - Cooking shut-off with time delayed water reintegration at the end of cooking.
  - Automatic raising of the basket at the end of cooking.
  - Possibility to manage the position of the basket: first drip and then unload or direct front unload.
  - Heating:
- DIRECTLY HEATED GAS:**
- Ignited with a manual piezoelectric and pilot flame.
  - Heated by tubular boilers and high-performance AISI-304 stainless steel.
  - Smoke extraction grille.
  - Set of nozzles for different types of gas.
- Tap with a safety valve and thermocouple.
  - Safety thermostat to protect against overheating and lack of water.
- DIRECTLY HEATED ELECTRIC:**
- Heated by a set of electric heating elements.
  - Safety thermostat which ensures that the machine does not operate in the event of overheating or insufficient water.
  - Temperature control (50 - 120 °C).
  - Standard operating voltage of 400V-3N-50Hz
- INDIRECTLY HEATED STEAM WITH DOUBLE WALL:**
- Double wall with AISI-304 stainless steel bottom and walls.
  - Heated by steam (from the user's connection) with a counter-pressure electrovalve that allows steam to be added gradually to the double wall.
  - Pressure control of the double wall through a pressure switch and a safety valve set to 0.5 bar, depression valve and gauge.

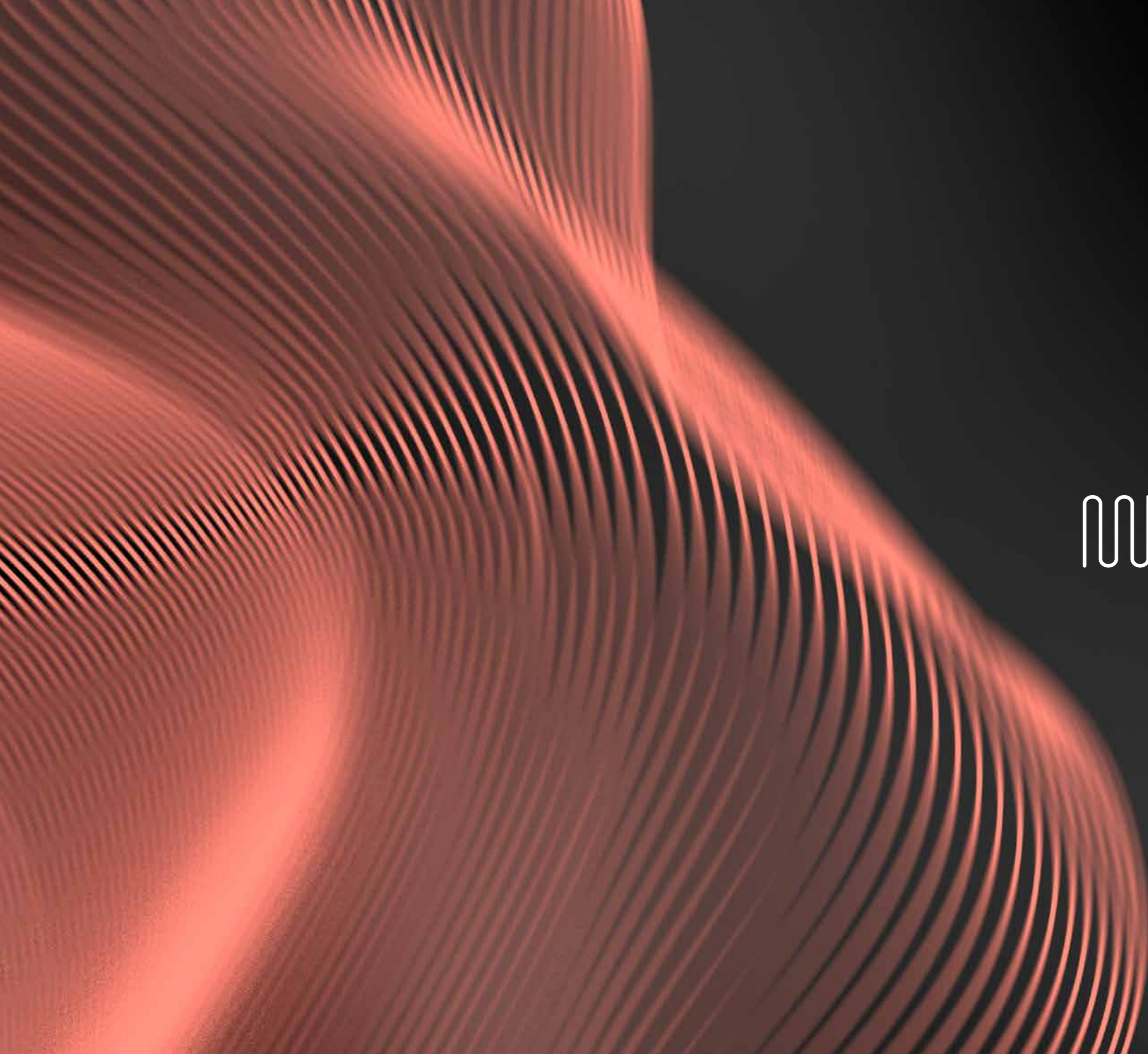

Ovens



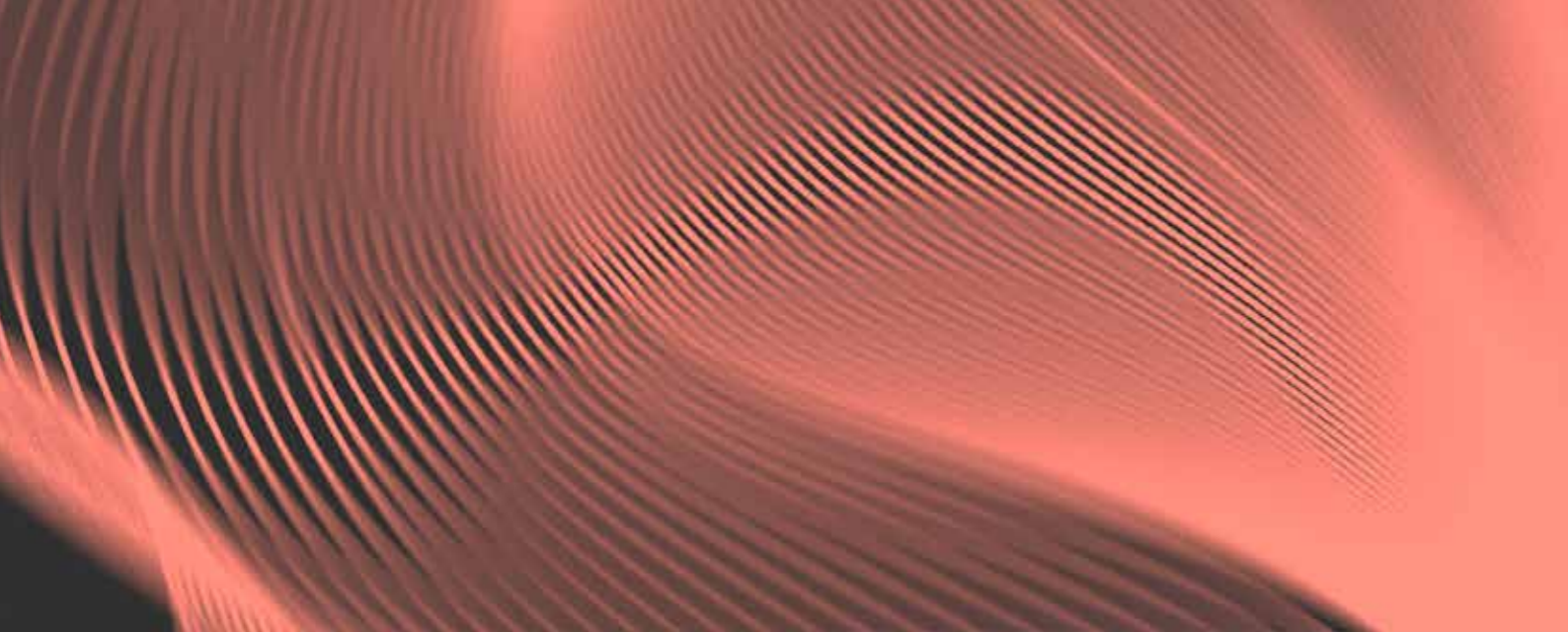

A new era  
of intelligent  
cooking



Access the website



Sales brochure

# Ovens

Compact ovens - iKORE Kompact .....	129
Industrial combi ovens - iKORE .....	133
— Advance .....	133
— Concept .....	147
Vacuum packers .....	161
Set-ups .....	163
— Stacking solutions .....	163
— Cook&Chill solutions .....	164
Other accessories .....	167
— Cleaning, racks, trolleys, containers .....	167

A new era of intelligent cooking



User experience

**A chef centred design**

Designed all through with the professionals' needs in mind, making it the perfect balance of quality, efficiency and comfort.



Food safety

**Hygiene, above all**

HACCP system, renewal of the inner water tank every 24h, 6-level automatic cleaning and more, to always guarantee the wellbeing of the consumer.

Open access through MyFagor



Smart cooking

**It's intelligence, not magic**

Powered by digital and technological intelligence to standardise the culinary processes in the most efficient way thanks to iCooking, Additional functions and Multitray.



Climate control

**Your desired cooking results**

Complete precision in the cooking chamber due to the humidity sensor and uniform heat distribution with a 6-speed two-way ventilation system.



Robust design

**Built to last**

The structure is 100% stainless steel and IPX5 protection, to face any culinary challenges with the highest demanding standards.



FagorKconnect

**Connected for a maximum performance**

Connected to ease, supervise and manage the daily work with a realtime vision and in a remote way.

**\*Standard in Advance models.**



iKORE ovens

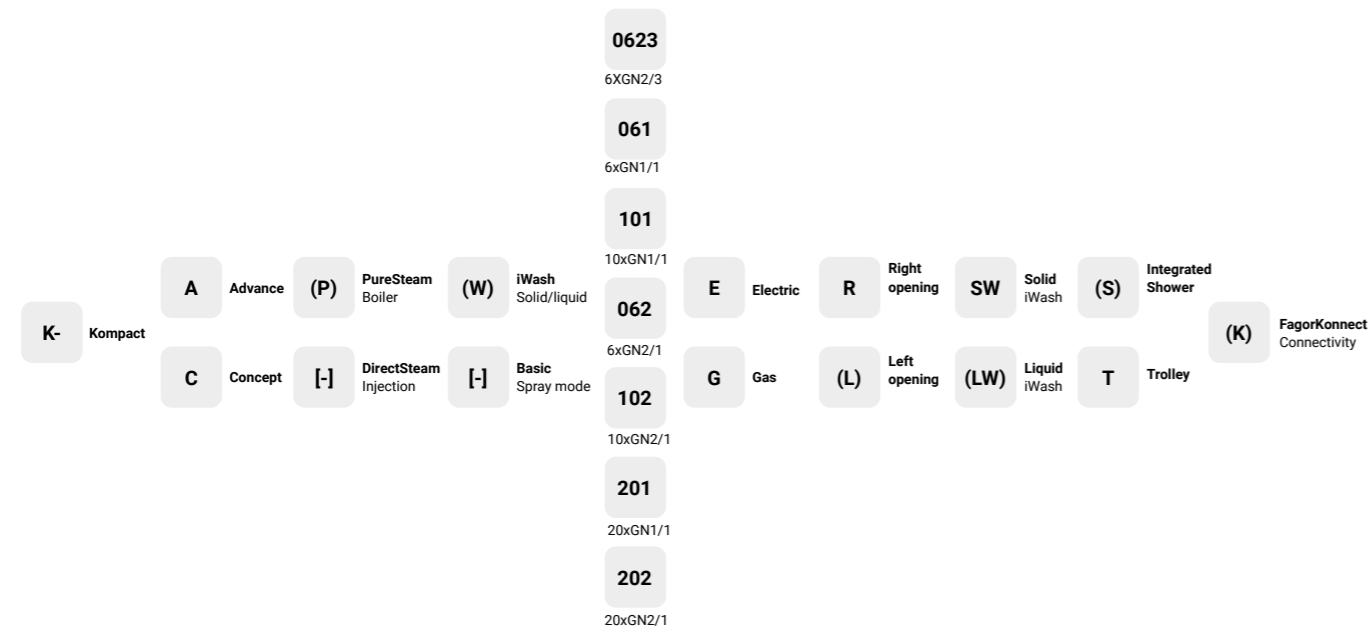

Customized to taste

ADVANCE

**Cooking quality, efficiency and intelligence.**

For the more revolutionary, those who pursue innovation through the latest technological advances, in a culinary world full of creativity.



Features	APW	AP	AW	A
<b>PureSteam</b> (boiler) 100% pure steam generator, with programmed descaling.	•	•	-	-
<b>DirectSteam</b> (Injection)	-	-	•	•
<b>iClima</b> Management and regulation of the real humidity in the chamber with 1% accuracy.	•	•	•	•
<b>EZ sensor</b> Internal multipoint core temperature probe.	•	•	•	•
<b>Multiprobe</b> Possibility to use up to 3 probes in the same cooking process: EZ sensor + 2 external probes (SV/ST).	◦	◦	◦	◦
<b>Functions</b>				
<b>FagorCookingCenter</b> (recipe collection)	•	•	•	•
<b>mCooking</b> - Manual cooking modes: Low and super-steam (30-130°C), Mixed (30-300°C) and Convection (30-300°C).	•	•	•	•
<b>iCooking</b> Intelligent cooking processes with automatic adjustment of their phases and parameters.	•	•	•	•
<b>iFunctions</b> Intelligent cooking processes with automatic adjustment of their phases and parameters.	•	•	•	•
<b>Multitray</b> Cooking management system by time and tray in the same climate.	•	•	•	•
<b>Control</b>				
<b>FagorTouch</b> 10.1" TFT capacitive glass display (7" on 0623 oven and Kompact versions)	•	•	•	•
<b>EasyCooking</b> Owner-customised interface with user and password control.	•	•	•	•
<b>Hygiene</b>				
<b>iWash SW</b> Efficient cleaning system with solid detergent and rinse aid.	•	-	•	-
<b>iWash LW</b> Efficient cleaning system with liquid detergent and possibility of remote execution.	◦	-	◦	-
<b>Integrated hand-held retractable shower.</b>	◦	◦	◦	◦
<b>HACCP</b> available remotely and with USB	•	•	•	•
<b>Connectivity</b>				
<b>FagorKconnect</b>	•	•	•	•
<b>Ethernet / Wifi</b>	•	•	•	•
<b>USB port</b>	•	•	•	•

- Standard
- Optional
- Not available

CONCEPT

**Simplicidad, potencia y robustez.**

For the more conservative, faithful to the traditional gastronomic methods, but are looking for the maximum performance in a quick and easy way.



Features	CPW	CP	CW	C
<b>PureSteam</b> (boiler) 100% pure steam generator, with programmed descaling.	•	•	-	-
<b>DirectSteam</b> (Injection)	-	-	•	•
<b>ClimaControl</b> Management and regulation of the real humidity in the chamber with 10% accuracy.	•	•	•	•
<b>EZ sensor</b> Internal multipoint core temperature probe.	•	•	•	•
<b>Monoprobe</b> Possibility to use only one probe per cooking: EZ sensor or external probe (SV)	◦	◦	◦	◦
<b>Functions</b>				
<b>FagorRecipeCenter</b> (recipe collection)	•	•	•	•
<b>mCooking</b> - Manual cooking modes: Low and super-steam (30-130°C), Mixed (30-300°C) and Convection (30-300°C).	•	•	•	•
<b>Cooking mode</b> Predefined cooking recipes.	•	•	•	•
<b>Funciones adicionales</b> Predefined cooking processes.	•	•	•	•
-	-	-	-	-
<b>Control</b>				
<b>FagorDial</b> 2.8" display with rotary push control and manual buttons with segment display.	•	•	•	•
-	-	-	-	-
<b>Higiene</b>				
<b>iWash SW</b> Efficient cleaning system with solid detergent and rinse aid.	•	-	•	-
<b>iWash LW</b> Efficient cleaning system with liquid detergent and possibility of remote execution.	◦	-	◦	-
<b>Integrated hand-held retractable shower.</b>	◦	◦	◦	◦
<b>HACCP</b> available remotely and with USB	•	•	•	•
<b>Connectivity</b>				
-	-	-	-	-
-	-	-	-	-
<b>USB port</b>	•	•	•	•





Explore the many benefits that FagorKonnnect provides, and find out in detail how you can specifically enhance the functionality of our iKORE ovens.

#### Recipe management:

- Import and export recipes from/to multiple ovens in bulk.
- Easy recipe creation and recipe repository By Fagor
- Create carts combining several recipes, sharing the same climate.
- Import recipes, carts and/or folders from the oven to FagorKonnnect

#### Detailed data displayed in real time:

- Phase or recipe
- Cooking Mode
- Cooking control
- Temperature
- Probe temperature setpoint
- Humidity level
- Turbine Speed Level
- Humidification level
- Door Status
- Phase Remaining Time
- Probe temperature

#### Specific graphs designed for the ovens analysis:

- Device status (cooking, washing, sat menu, alarm, available, offline, offline...)
- Cooked foods performed by day and by device
- Washes executed per day and device
- Device productivity
- Washing occupation
- Executed cooks by recipe
- Error analysis

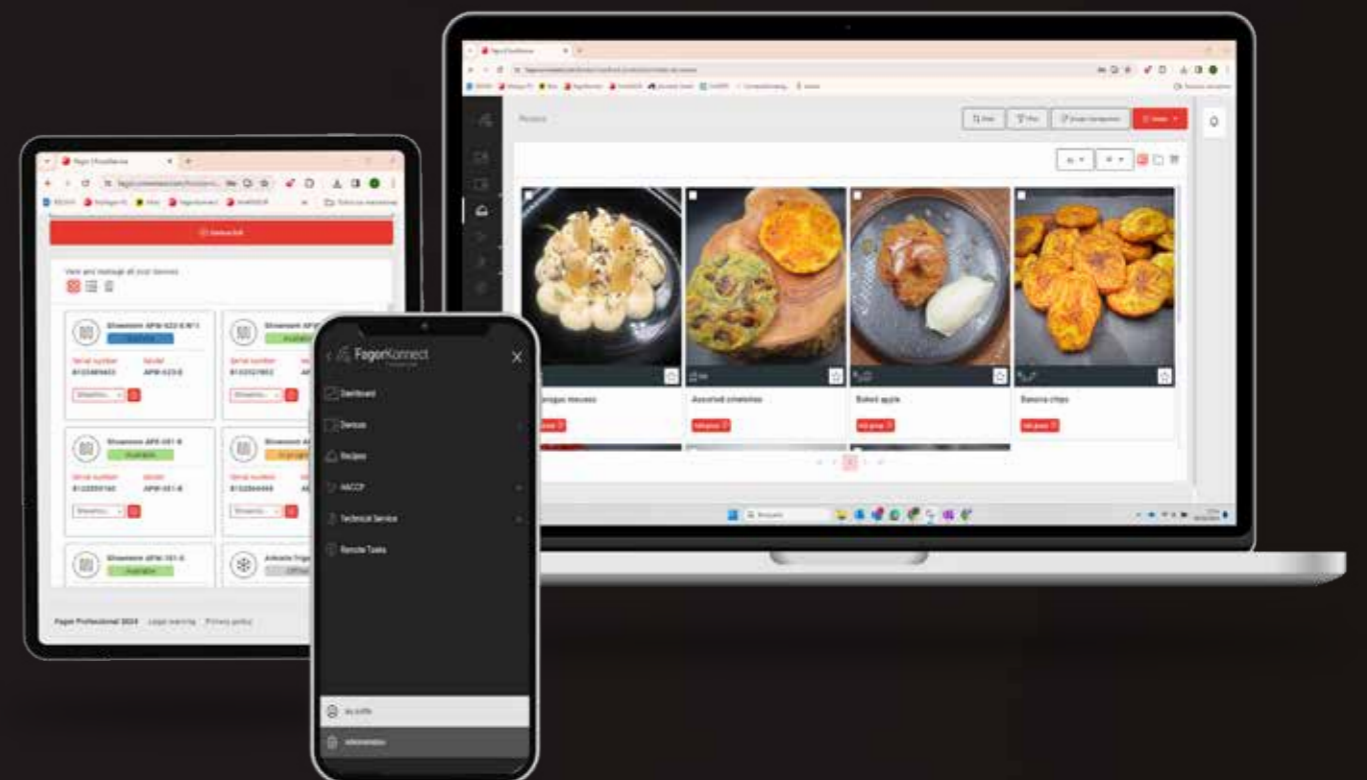



ADVANCE





## iKORE Kompact 061

PureSteam or DirectSteam





General information		Version	
FIELD	DATA	 ELECTRIC (E)	 NATURAL GAS (G)
Capacity (standard)	Racks and tray type	6 GN1/1	No version available
	Spacing between rack rails	47mm	-
Energy supply (standard)	Electric power	7,8 kW	-
	Frecuency	50/60 Hz	-
	Voltage	380-415V 3N	-
	Width	530mm	-
Dimensions and weight	Depth (with handle)	815mm (874mm)	-
	Height	760mm	-
	Net weight (gross)	~118,5Kg (145Kg)	-

## Codes and prices

HUMIDITY	WASHING	SHOWER	MODEL	 CODE	€	 CODE	€
 PureSteam boiler	Solid iWash	-	K-APW-061-E SW R K	19103865	-	-	-
	Modo Spray	-	K-AP-061-E R K	19103864	-	-	-
 DirectSteam injection	Solid iWash	-	K-AW-061-E SW R K	19103863	-	-	-
	Modo Spray	-	K-A-061-E R K	19103862	-	-	-

## Configurable options

OPTION	NAMING	DESCRIPTION	CONF. CODE	€
Opening	L	Inverted opening with door hinge on left-hand side	0103-0001	-
Washing	LW*	Liquid iWash *Only available for models with W	0107-0001	-
VOLTAGE OPTIONS			CONF. CODE	€
	230V 3~ 50/60Hz		0102-0001	-
	230V 1N 50/60Hz		0102-0002	-

\* Not convertible oven, standard configuration only

\* Marine version not available

## Accessories K-061

EXTRACTION	MODEL	CONDENSATION HOOD	ACTIVATED CARBON FILTER	HEIGHT (mm)	CODE	€
	EXH-K	x	-	220	19103309	-
	EXH-K CA	x	x	430	19103398	-
	FCA	Replacement for activated carbon filter of EXH-K CA			19107067	-
	Kit EXT-K	Extraction kit for EXH-K hoods			19103375	-
STANDS	MODEL	RACKS (SPACING)	WHEELS	HEIGHT (mm)	CODE	€
	SH-K 85	-	-	850	19103256	-
	SH-R K 85	-	x	850	19103257	-
	SH-B K 85	9 GN1/1 (62mm)	-	850	19103319	-
	SH-BR K 85	9 GN1/1 (62mm)	x	850	19103331	-
	SH-K 103	-	-	1030	19103553	-
	SH-R K 103	-	x	1030	19103554	-
	SH-B K 103	10 GN1/1 (62mm)	-	1030	19103555	-
	SH-BR K 103	10 GN1/1 (62mm)	x	1030	19103556	-
	MSH-K	Levelling support to place a compact oven on a cabinet or stand			19103258	-
EXTERNAL SHOWER KIT	MODEL	DESCRIPTION	CODE	€		
	Kit ducha	External shower kit (not retractable)	19004504	-		
FASTENING KIT	MODEL	DESCRIPTION	CODE	€		
	Kit A-11K	Fastening kit for iKORE Kompact ovens	19106481	-		

x Included

- Not included

For more accessories, check 'other accessories' chapter

ADVANCE

## iKORE Kompact 101

PureSteam or DirectSteam

FagorTouch  
7

General information		Version	
FIELD	DATA	ELECTRIC (E)	NATURAL GAS (G)
Capacity (standard)	Racks and tray type	10 GN1/1	No version available
	Spacing between rack rails	47mm	-
Energy supply (standard)	Electric power	12,8 kW	-
	Frecuency	50/60 Hz	-
	Voltage	380-415V 3N	-
	Width	530mm	-
Dimensions and weight	Depth (with handle)	815mm (874mm)	-
	Height	940mm	-
	Net weight (gross)	~139Kg (174Kg)	-

## Codes and prices

HUMIDITY	WASHING	SHOWER	MODEL	CODE	€	CODE	€
PureSteam boiler	Solid iWash	-	K-APW-101-E SW R K	19103869	-	-	-
	Spray mode	-	K-AP-101-E R K	19103868	-	-	-
DirectSteam injection	Solid iWash	-	K-AW-101-E SW R K	19103867	-	-	-
	Spray mode	-	K-A-101-E R K	19103866	-	-	-

## Configurable options

OPTION	NAMING	DESCRIPTION	CONF. CODE	€
Opening	L	Inverted opening with door hinge on left-hand side	0103-0001	-
Washing	LW*	Liquid iWash *Only available for models with W	0107-0001	-
VOLTAGE OPTIONS			CONF. CODE	€
	230V 3~ 50/60Hz		0102-0001	-
	230V 1N 50/60Hz		0102-0002	-

\* Not convertible oven, standard configuration only

\* Marine version not available

## AccessoriesK-101

EXTRACTION	MODEL	CONDENSATION HOOD	ACTIVATED CARBON FILTER	HEIGHT (mm)	CODE	€
	EXH-K	x	-	220	19103309	-
	EXH-K CA	x	x	430	19103398	-
	FCA	Replacement for activated carbon filter of EXH-K CA			19107067	-
	Kit EXT-K	Extraction kit for EXH-K hoods			19103375	-

STANDS	MODEL	RACKS (SPACING)	WHEELS	HEIGHT (mm)	CODE	€
	SH-K 85	-	-	850	19103256	-
	SH-R K 85	-	x	850	19103257	-
	SH-B K 85	9 GN1/1 (62mm)	-	850	19103319	-
	SH-BR K 85	9 GN1/1 (62mm)	x	850	19103331	-
	SH-K 103	-	-	1030	19103553	-
	SH-R K 103	-	x	1030	19103554	-
	SH-B K 103	10 GN1/1 (62mm)	-	1030	19103555	-
	SH-BR K 103	10 GN1/1 (62mm)	x	1030	19103556	-

	MSH-K	Levelling support to place a compact oven on a cabinet or stand			19103258	-
--	-------	---	--	--	----------	---

EXTERNAL SHOWER KIT	MODEL	DESCRIPTION	CODE	€
	Kit shower	External shower kit (not retractable)	19004504	-
FASTENING KIT	MODEL	DESCRIPTION	CODE	€
	Kit A-11K	Fastening kit for iKORE Kompact ovens	19106481	-

x Included

- Not included

For more accessories, check 'other accessories' chapter

ADVANCE

## iKORE 0623

PureSteam or DirectSteam



General information		Version	
FIELD	DATA	ELECTRIC (E)	NATURAL GAS (G)
Capacity (standard)	Racks and tray type	6 GN2/3	No version available
	Spacing between rack rails	47mm	-
Energy supply (standard)	Electric power	5,8 kW	-
	Frecuency	50/60 Hz	-
	Voltage	380-415V 3N	-
Dimensions and weight	Width	660mm	-
	Depth (with handle)	564mm (630mm)	-
	Height	570mm (600mm)	-
	Net weight (gross)	~66,5Kg (71,5Kg)	-

## Codes and prices

HUMIDITY	WASHING	SHOWER	MODEL	CODE	€	CODE	€
PureSteam boiler	Solid iWash	•	APW-0623-E R SW S K	19079298	€ STOCK	-	-
		-	APW-0623-E R SW K	19106932	-	-	-
DirectSteam injection	Solid iWash	•	AW-0623-E R SW S K	19106933	-	-	-
		-	AW-0623-E R SW K	19079299	€ STOCK	-	-

## Configurable options

OPTION	NAMING	DESCRIPTION	CONF. CODE	€	
Lavado	LW*	iWash Líquido *Solo para modelos con W	0107-0001	-	
VOLTAGE OPTIONS				CONF. CODE	€
	230V 3~ 50/60Hz		0102-0061	-	
	230V 1N 50/60Hz		0102-0062	-	
	Marine 440V 3~ 50/60Hz *	*External module, not integrated in the oven	0102-0063	-	

## Accessories 0623

EXTRACTION	MODEL	CONDENSATION HOOD	ACTIVATED CARBON FILTER	HEIGHT (mm)	CODE	€
	EXH-23	x	-	255	19073213	-
	EXH-23-CA	x	x	330	19103376	-
	FCA	Replacement for activated carbon filter of EXH-23 CA			19107067	-
	Kit EXT-23	Extraction kit for EXH-23 hoods			19096418	-
	STANDS					
	SH-23	-	-	850	19103553	-
	SH-23-R	-	x	850	19103554	-
	SH-23-B	2 x 6 GN2/3 (68mm)	-	850	19103555	-
	SH-23-RB	2 x 6 GN2/3 (68mm)	x	850	19103556	-
	SH-23-RBM	Mobile stand with 2 x 1.5l bottles for clean water and drainage	x	850	19103256	-
	SHP-23	Wall support for 0623 ovens			19103257	-
	MSH-23	Levelling support to place a 0623 oven on a cabinet or stand			19103319	-
FASTENING KIT						
	Kit A-23	Fastening kit for 0623 ovens			19106481	-

x Included  
- Not included

For more accessories, check 'other accessories' chapter



## ADVANCE

## iKORE 061

## PureSteam or DirectSteam



General information		Version	
FIELD	DATA	ELECTRIC (E)	NATURAL GAS (G)
Capacity (standard)	Racks and tray type	6 GN1/1	6 GN1/1
	Spacing between rack rails	68mm	68mm
Energy supply (standard)	Electric / gas power	11,1 kW	0,83 kW / 12 kW
	Frecuency	50/60 Hz	50 Hz
	Voltage	380-415V 3N	230V 1N
Dimensions and weight	Width	895mm	895mm
	Depth (with handle)	817mm (883mm)	817mm (883mm)
	Gas with boiler versions	-	922mm (988mm)
	Height (with hinge)	846mm (877mm)	846mm (877mm)
	Net weight (gross)	~118,5Kg (145Kg)	~146Kg (162,5Kg)

## Codes and prices

HUMIDITY	WASHING	SHOWER	MODEL	CODE	€	CODE	€
PureSteam boiler	Solid iWash	•	APW-061-(E/G) R SW S K	19078616	STOCK	-	19088205
		-	APW-061-(E/G) R SW K	19106934	-	19106935	-
DirectSteam injection	Solid iWash	•	AW-061-(E/G) R SW S K	19103818	STOCK	-	19106936
		-	AW-061-(E/G) R SW K	19078613	STOCK	-	19088204

## Configurable options

OPTION	NAMING	DESCRIPTION	CONF. CODE	€
Opening	L	Inverted opening with door hinge on left-hand side	0103-0001	-
Washing	LW*	Liquid iWash *Only available for models with W	0107-0001	-

VOLTAGE OPTIONS	CONF. CODE	€	GAS OPTIONS	CONF. CODE	€
230V 3~ 50/60Hz	0102-0001	-	Butane-Propane LPG	0101-0001	-
230V 1N 50/60Hz	0102-0002	-	Town gas TG	0101-0002	-
Marine 440V 3~ 50/60Hz	0102-0003	-			
230V 1N 60Hz	0102-0007	-			
230V 2~ 50Hz	0102-0008	-			
230V 2~ 60Hz	0102-0009	-			

## Accessories 061

EXTRACCIÓN	MODEL	CONDENSATION HOOD	ACTIVATED CARBON FILTER	LEFT OPENING (L)	HEIGHT (mm)				CODE	€
	EXH-11	x	-	-	303	x	-	-	19085190	-
	EXH-11 L	x	-	x	303	x	-	-	19103220	-
	EXH-11-CA	x	x	-	363	x	-	-	19103393	-
	EXH-11-CA L	x	x	x	363	x	-	-	19104232	-

FCA	Replacement for activated carbon filter of EXH-11 CA		x	-	-	-	-	-	19107067	-
	Kit EXT-11	Extraction kit for EXH-11 hoods		x	-	-	-	-	19096417	-
	Kit CTG-11	Flue gas exhaust stack for 061 ovens		-	x	x	x	-	19095581	-

STANDS	MODEL	RACKS ( SPACING)	WHEELS	DOORS	HEIGHT (mm)				CODE	€
	SH-11-65	-	-	-	650	x	x	-	19082326	-
						-	-	x	19082327	-
	SH-11-65 R	-	x	-	650	x	x	-	19083237	-
						-	-	x	19083234	-

	SH-11-65 B	2 x 6 GN1/1 (68mm)	-	-	650	x	x	-	19082006	-
						-	-	x	19082005	-
	SH-11-65 BR	2 x 6 GN1/1 (68mm)	x	-	650	x	x	-	19083238	-
						-	-	x	19083239	-

	SH-11- 65 BCP	2 x 6 GN1/1 (68mm)	-	x	650	x	x	-	19079211	-
						-	-	x	19079233	-

	SH-11-85	-	-	-	850	x	x	-	19103370	-
						-	-	x	19103413	-

	SH-11-85 R	-	x	-	850	x	x	-	19103373	-
						-	-	x	19103415	-

	SH-11-85 B	2 x 6 GN1/1 (68mm)	-	-	850	x	x	-	19103369	-
						-	-	x	19103442	-

	SH-11-85 BR	2 x 6 GN1/1 (68mm)	x	-	850	x	x	-	19103381	-
						-	-	x	19103443	-

STRUCTURES	MODEL	RACKS ( SPACING)				CODE	€
	EB-061*	Mobile rack for 6 GN1/1 trays (62mm)	x	x	x	19011559	-

	EP-061*	Mobile rack for 18 plates Ø31 (64mm) * GE-11 and CP-11(-R) required	x	x	x	19013353	-
--	---------	--	---	---	---	----------	---

TROLLEYS	MODEL	DESCRIPTION				CODE	€
	GE-11	Structure rack for EB-061 and EP-061	x	x	x	19011569	-
	CP-11	Structure support trolley for oven on SH-11-65	x	x	x	19013352	-
	CP-11-R	Adjustable structure support trolley for oven on SH-11	x	x	x	19018752	-

PLINTH	MODEL	DESCRIPTION				CODE	€
	Kit Z-11	Plinth kit	x	x	-	19087303	-
			-	-	x	19087305	-

x Included - Not included

For more accessories, check 'other accessories' chapter

For electric ovens only

For gas ovens only

Only for gas ovens with boiler: APW-061-G

## ADVANCE

## iKORE 101

## PureSteam or DirectSteam



General information		Version	
FIELD	DATA	ELECTRIC (E)	NATURAL GAS (G)
Capacity (standard)	Racks and tray type	10 GN1/1	10 GN1/1
	Spacing between rack rails	68mm	68mm
Energy supply (standard)	Electric / gas power	18,6 kW	0,83 kW / 18 kW
	Frecuency	50/60 Hz	50 Hz
	Voltage	380-415V 3N	230V 1N
Dimensions and weight	Width	895mm	895mm
	Depth (with handle)	817mm (883mm)	817mm (883mm)
	Gas with boiler versions	-	922mm (988mm)
	Height (with hinge)	1117mm (1149mm)	1117mm (1149mm)
	Net weight (gross)	~139Kg (174Kg)	~162Kg (197Kg)

## Codes and prices

HUMIDITY	WASHING	SHOWER	MODEL	CODE	€	CODE	€
PureSteam boiler	Solid iWash	•	APW-101-(E/G) R SW S K	19078668	STOCK	-	19088215
		-	APW-101-(E/G) R SW K	19107006	-	19107007	-
DirectSteam injection	Solid iWash	•	AW-101-(E/G) R SW S K	19103817	-	19107008	-
		-	AW-101-(E/G) R SW K	19078671	STOCK	-	19088214

## Configurable options

OPTION	NAMING	DESCRIPTION	CONF. CODE	€
Opening	L	Inverted opening with door hinge on left-hand side	0103-0001	-
Washing	LW*	Liquid iWash *Only available for models with W	0107-0001	-

VOLTAGE OPTIONS	CÓD. CONFIG.	€	GAS OPTIONS	CONF. CODE	€
230V 3~ 50/60Hz	0102-0021	-	Butane-Propane LPG	0101-0001	-
Marine 440V 3~ 50/60Hz	0102-0023	-	Town gas TG	0101-0002	-
230V 1N 60Hz	0102-0027	-			
230V 2~ 50Hz	0102-0028	-			
230V 2~ 60Hz	0102-0029	-			

## Accessories 101

EXTRACTION	MODEL	CONDENSATION HOOD	ACTIVATED CARBON FILTER	LEFT OPENING (L)	HEIGHT (mm)				CODE	€
	EXH-11	x	-	-	303	x	-	-	19085190	-
	EXH-11 L	x	-	x	303	x	-	-	19103220	-
	EXH-11-CA	x	x	-	363	x	-	-	19103393	-
	EXH-11-CA L	x	x	x	363	x	-	-	19104232	-
	FCA	Replacement for activated carbon filter of EXH-11 CA				x	-	-	19107067	-
	Kit EXT-11	Extraction kit for EXH-11 hoods				x	-	-	19096417	-
	Kit CTG-11	Flue gas exhaust stack for 061 ovens				-	x	x	19095581	-
STANDS	MODEL	RACKS ( SPACING)	WHEELS	DOORS	HEIGHT (mm)				CODE	€
	SH-11-65	-	-	-	650	x	x	-	19082326	-
								x	19082327	-
	SH-11-65 R	-	x	-	650	x	x	-	19083237	-
								x	19083234	-
	SH-11-65 B	2 x 6 GN1/1 (68mm)	-	-	650	x	x	-	19082006	-
								x	19082005	-
	SH-11-65 BR	2 x 6 GN1/1 (68mm)	x	-	650	x	x	-	19083238	-
							x	19083239	-	
	SH-11- 65 BCP	2 x 6 GN1/1 (68mm)	-	x	650	x	x	-	19079211	-
								x	19079233	-
	SH-11-85	-	-	-	850	x	x	-	19103370	-
								x	19103413	-
	SH-11-85 R	-	x	-	850	x	x	-	19103373	-
								x	19103415	-
	SH-11-85 B	2 x 6 GN1/1 (68mm)	-	-	850	x	x	-	19103369	-
								x	19103442	-
	SH-11-85 BR	2 x 6 GN1/1 (68mm)	x	-	850	x	x	-	19103381	-
								x	19103443	-
STRUCTURES	MODEL	RACKS ( SPACING)							CODE	€
	EB-101*	Mobile rack for 10 GN1/1 trays (62mm)				x	x	x	19011561	-
	EP-101*	Mobile rack for 30 plates Ø31 (64mm) * GE-11 and CP-11(-R) required				x	x	x	19013354	-
TROLLEYS	MODEL	DESCRIPTION							CODE	€
	GE-11	Structure rack for EB-061 and EP-061				x	x	x	19011569	-
	CP-11	Structure support trolley for oven on SH-11-65				x	x	x	19013352	-
	CP-11-R	Adjustable structure support trolley for oven on SH-11				x	x	x	19018752	-
PLINTH	MODEL	DESCRIPTION							CODE	€
	Kit Z-11	Plinth kit				x	x	-	19087303	-
						-	-	x	19087305	-

x Included - Not included

For more accessories, check 'other accessories' chapter

For electric ovens only

For gas ovens only

Only for gas ovens with boiler: APW-101-G

ADVANCE

## iKORE 062

PureSteam or DirectSteam



General information		Version	
FIELD	DATA	ELECTRIC (E)	NATURAL GAS (G)
Capacity (standard)	Racks and tray type	6 GN2/1 (12 GN1/1)	Version no disponible
	Spacing between rack rails	68mm	-
Energy supply (standard)	Electric / gas power	22,2 kW	-
	Frecuency	50/60 Hz	-
	Voltage	380-415V 3N	-
Dimensions and weight	Width	1134mm	-
	Depth (with handle)	1066mm (1134mm)	-
	Height (with hinge)	846mm (877mm)	-
	Net weight (gross)	~190Kg (220Kg)	-

Codes and prices							
HUMIDITY	WASHING	SHOWER	MODEL	CÓDIGO	€	CÓDIGO	€
PureSteam boiler	Solid iWash	•	APW-062-E R SW S	19087724	-	-	-
		-	APW-062-E R SW	19107009	-	-	-
DirectSteam injection	Solid iWash	•	AW-062-E R SW S	19107040	-	-	-
		-	AW-062-E R SW	19088209	-	-	-

Configurable options				
OPTION	NAMING	DESCRIPTION	CONF. CODE	€
Apertura	L	Inverted opening with door hinge on left-hand side	0103-0001	-
Lavado	LW*	Liquid iWash *Only available for models with W	0107-0001	-

VOLTAGE OPTIONS		CONF. CODE	€
	230V 3~ 50/60Hz	0102-0011	-
	Marine 440V 3~ 50/60Hz	0102-0013	-

## Accessories 062

STANDS	MODEL	RACKS ( SPACING)	WHEELS	DOORS	HEIGHT (mm)	CODE	€
	SH-21-65	-	-	-	650	19084190	-
	SH-21-65 R	-	x	-	650	19084191	-
	SH-21-65 B	6 GN1/1 + 6 GN2/1 (68mm)	-	-	650	19083224	-
	SH-21-65 BR	6 GN1/1 + 6 GN2/1 (68mm)	x	-	650	19084192	-
	SH-21-65 BCP	6 GN1/1 + 6 GN2/1 (68mm)	-	x	650	19082394	-
	SH-21-85	-	-	-	850	19103382	-
	SH-21-85 R	-	x	-	850	19103383	-
	SH-21-85 B	6 GN1/1 + 6 GN2/1 (68mm)	-	-	850	19103384	-
	SH-21-85 BR	6 GN1/1 + 6 GN2/1 (68mm)	x	-	850	19103385	-
STRUCTURES	MODEL	RACKS ( SPACING)			CODE	€	
	EB-062*	Mobile rack for 6 GN2/1 trays (62mm)			19095517	-	
	EP-062*	Mobile rack for 28 plates Ø31 (75mm) * GE-21 and CP-21(-R) required			19095518	-	
TROLLEYS	MODEL	DESCRIPTION			CODE	€	
	GE-21	Structure rack for EB-062 and EP-062			19011570	-	
	CP-21	Structure support trolley for oven on SH-21			19013355	-	
	CP-21-R	Adjustable structure support trolley for oven on SH-21			19018751	-	
PLINTH	MODEL	DESCRIPTION			CODE	€	
	Kit Z-21	Plinth kit			19087306	-	

x Included - Not included

For more accessories, check 'other accessories' chapter

ADVANCE

## iKORE 102

PureSteam or DirectSteam

FagorTouch  
10.1"

## General information

FIELD	DATA	Version	
		ELECTRIC (E)	NATURAL GAS (G)
Capacity (standard)	Racks and tray type	10 GN2/1 (20 GN1/1)	10 GN2/1 (20 GN1/1)
	Spacing between rack rails	68mm	68mm
Energy supply (standard)	Electric / gas power	33,6 kW	0,83 kW / 35 kW
	Frecuency	50/60 Hz	50 Hz
Dimensions and weight	Voltage	380-415V 3N	230V 1N
	Width	1134mm	1134mm
	Depth (with handle)	1066mm (1134mm)	1066mm (1134mm)
	Height (with hinge)	1117mm (1149mm)	1117mm (1149mm)
	Net weight (gross)	~217Kg (258Kg)	~230Kg (265,5Kg)

## Codes and prices

HUMIDITY	WASHING	SHOWER	MODEL	CODE	€	CODE	€
PureSteam boiler	Solid iWash	•	APW-102-(E/G) R SW S K	19079785	-	19088221	-
		-	APW-102-(E/G) R SW K	19107041	-	19107042	-
DirectSteam injection	Solid iWash	•	AW-102-(E/G) R SW S K	19107043	-	19107045	-
		-	AW-102-(E/G) R SW K	19079784	-	19088220	-

## Configurable options

OPTION	NAMING	DESCRIPTION	CONF. CODE	€
Opening	L	Inverted opening with door hinge on left-hand side	0103-0001	-
Washing	LW*	Liquid iWash *Only available for models with W	0107-0001	-

VOLTAGE OPTIONS	CONF. CODE	€	GAS OPTIONS	CONF. CODE	€
230V 3~ 50/60Hz	0102-0031	-	Butane-Propane LPG	0101-0001	-
Marine 440V 3~ 50/60Hz	0102-0033	-	Town gas TG	0101-0002	-
230V 1N 60Hz	0102-0037	-			
230V 2~ 50Hz	0102-0038	-			
230V 2~ 60Hz	0102-0039	-			

## Accessories 102

EXTRACTION	MODEL	DESCRIPTION	CODE	€
	Kit CTG-12*	Flue gas discharge stack 102 * For gas ovens only	19095590	-

STANDS	MODEL	RACKS ( SPACING)	WHEELS	DOORS	HEIGHT (mm)	CODE	€
	SH-21-65	-	-	-	650	19084190	-
	SH-21-65 R	-	x	-	650	19084191	-
	SH-21-65 B	6 GN1/1 + 6 GN2/1 (68mm)	-	-	650	19083224	-
	SH-21-65 BR	6 GN1/1 + 6 GN2/1 (68mm)	x	-	650	19084192	-
	SH-21-65 BCP	6 GN1/1 + 6 GN2/1 (68mm)	-	x	650	19082394	-
	SH-21-85	-	-	-	850	19103382	-
	SH-21-85 R	-	x	-	850	19103383	-
	SH-21-85 B	6 GN1/1 + 6 GN2/1 (68mm)	-	-	850	19103384	-
	SH-21-85 BR	6 GN1/1 + 6 GN2/1 (68mm)	x	-	850	19103385	-

STRUCTURES	MODEL	RACKS ( SPACING)	CODE	€
	EB-102*	Mobile rack for 10 GN2/1 trays (62mm)	19011562	-
	EP-102*	Mobile rack for 52 plates Ø31 (75mm) * Necesario GE-21 y CP-21(-R)	19013356	-

TROLLEYS	MODEL	DESCRIPTION	CODE	€
	GE-21	Structure rack for EB-102 and EP-102	19011570	-
	CP-21	Structure support trolley for oven on SH-21	19013355	-
	CP-21-R	Adjustable structure support trolley for oven on SH-21	19018751	-

PLINTH	MODEL	DESCRIPTION	CODE	€
	Kit Z-21	Plinth kit	19087306	-

x Included - Not included

For more accessories, check 'other accessories' chapter



ADVANCE

## iKORE 201

## PureSteam or DirectSteam

FagorTouch  
10.1"

General information		Version	
FIELD	DATA	ELECTRIC (E)	NATURAL GAS (G)
Capacity (standard)	Racks and tray type of trolley (T)*	20 GN1/1	20 GN1/1
	Spacing between rack rails	63mm	63mm
Energy supply (standard)	Electric / gas power	37,2 kW	1,55 kW / 36 kW
	Frecuency	50/60 Hz	50 Hz
	Voltage	380-415V 3N	230V 1N
Dimensions and weight	Width	935mm	935mm
	Depth (with handle)	966mm (1032mm)	966mm (1032mm)
	Height (with hinge)	1840mm (1871mm)	1840mm (1871mm)
	Net weight (gross)	~272,5Kg (331,5Kg)	~309Kg (341,5Kg)

## Codes and prices

HUMIDITY	WASHING	SHOWER	MODEL	CODE	€	CODE	€
PureSteam boiler	Solid iWash	•	APW-201-(E/G) R SW S T K	19079328	-	19088272	-
		-	APW-201-(E/G) R SW T K	19107046	-	19107049	-
DirectSteam injection	Solid iWash	•	AW-201-(E/G) R SW S T K	19107048	-	19107060	-
		-	AW-201-(E/G) R SW T K	19079330  STOCK	-	19091667	-

## Configurable options

OPTION	NAMING	DESCRIPTION	CONF. CODE	€
Washing	LW*	Liquid iWash *Only available for models with W	0107-0001	-
Trolley	Special T	Consult for other trolley configurations	-	consult

VOLTAGE OPTIONS	CONF. CODE	€	GAS OPTIONS	CONF. CODE	€
230V 3~ 50/60Hz	0102-0041	-	Butane-Propane LPG	0101-0001	-
Marine 440V 3~ 50/60Hz	0102-0043	-	Town gas TG	0101-0002	-
230V 1N 60Hz	0102-0047	-			
230V 2~ 50Hz	0102-0048	-			
230V 2~ 60Hz	0102-0049	-			

## Accessories 201

EXTRACTION	MODEL	DESCRIPTION	CODE	€
	Kit CTG-21*	Flue gas discharge stack for 201 * For gas ovens only	19095591	-
TROLLEYS	MODEL	RACKS (SPACING)	CODE	€
	CEB-201	20 GN1/1 (63mm)	19011551	-
	CEB-201-69	18 GN1/1 (69mm)	19103883	-
	CEB-201-80	16 GN1/1 (80mm)	19107454	-
	CEB-201-85	15 GN1/1 (85mm)	19107590	-
	CEP-201	50 plates Ø31 (75mm)	19013357	-
RAMP	MODEL	DESCRIPTION	CODE	€
	RH-201	Levelling ramp for 201 trolley	19044716	-
FASTENING KIT	MODEL	DESCRIPTION	CODE	€
	Kit A-20	Floor fastening kit for 201 ovens	19012270	-
KIT HANDLE	MODEL	DESCRIPTION	CODE	€
	Kit ASA	Side support kit for trolley handle	19087163	-

x Included - Not included

For more accessories, check 'other accessories' chapter

ADVANCE

## iKORE 202

## PureSteam or DirectSteam

FagorTouch  
10.1"

General information		Version	
FIELD	DATA	ELECTRIC (E)	NATURAL GAS (G)
Capacity (standard)	Racks and tray type of trolley (T)*	20 GN2/1 (40 GN1/1)	20 GN2/1 (40 GN1/1)
	Spacing between rack rails	63mm	63mm
Energy supply (standard)	Electric / gas power	67,2 kW	1,55 kW / 65 kW
	Frecuency	50/60 Hz	50 Hz
	Voltage	380-415V 3N	230V 1N
Dimensions and weight	Width	1165mm	1165mm
	Depth (with handle)	1074mm (1140mm)	1074mm (1140mm)
	Height (with hinge)	1840mm (1871mm)	1840mm (1871mm)
	Net weight (gross)	~338Kg (403,5Kg)	~357Kg (422,5Kg)

## Codes and prices

HUMIDITY	WASHING	SHOWER	MODEL	CODE	€	CODE	€
PureSteam calderín	Solid iWash	•	APW-202-(E/G) R SW ST K	19078839	-	19088278	-
		-	APW-202-(E/G) R SW T K	19107061	-	19107062	-
DirectSteam inyección	Solid iWash	•	AW-202-(E/G) R SW ST K	19107063	-	19107064	-
		-	AW-202-(E/G) R SW T K	19078837	-	19091670	-

## Configurable options

OPTION	NAMING	DESCRIPTION	CONF. CODE	€
Washing	LW*	Liquid iWash *Only available for models with W	0107-0001	-
Trolley	Special T	Consult for other trolley configurations	-	consultar

OPCIONES DE VOLTAJE	CONF. CODE	€	GAS OPTIONS	CONF. CODE	€
230V 3~ 50/60Hz	0102-0051	-	Butane-Propane LPG	0101-0001	-
Marine 440V 3~ 50/60Hz	0102-0053	-	Town gas TG	0101-0002	-
230V 1N 60Hz	0102-0057	-			
230V 2~ 50Hz	0102-0058	-			
230V 2~ 60Hz	0102-0059	-			

## Accessories 202

EXTRACTION	MODEL	DESCRIPTION	CODE	€
	Kit CTG-22*	Flue gas discharge stack for 202 *For gas ovens only	19095592	-
TROLLEYS	MODEL	RACKS (SPACING)	CODE	€
	CEB-202	20 GN2/1 (63mm)	19011550	-
	CEB-202-69	18 GN2/1 (69mm)	19103884	-
	CEB-202-80	16 GN2/1 (80mm)	19107481	-
	CEB-202-85	15 GN2/1 (85mm)	19107588	-
	CEP-202-90	90 plates Ø31 (75mm)	19081933	-
	CEP-202	100 plates Ø31 (75mm)	19011552	-
RAMP	MODEL	DESCRIPTION	CODE	€
	RH-202	Levelling ramp for 202 trolley	19034438	-
FASTENING KIT	MODEL	DESCRIPTION	CODE	€
	Kit A-20	Floor fastening kit for 202 ovens	19012270	-
KIT HANDLE	MODEL	DESCRIPTION	CODE	€
	Kit ASA	Side support kit for trolley handle	19087163	-

x Included - Not included

For more accessories, check 'other accessories' chapter

## CONCEPT

## iKORE 0623

## PureSteam or DirectSteam



General information		Version	
FIELD	DATA	ELECTRIC (E)	NATURAL GAS (G)
Capacity (standard)	Racks and tray type	6 GN2/3	Version no disponible
	Spacing between rack rails	47mm	-
Energy supply (standard)	Electric power	5,8 kW	-
	Frecuency	50/60 Hz	-
	Voltage	380-415V 3N~	-
Dimensions and weight	Width	660mm	-
	Depth (with handle)	564mm (630mm)	-
	Height	570mm (600mm)	-
	Net weight (gross)	~66,5Kg (71,5Kg)	-

## Codes and prices

HUMIDITY	WASHING	SHOWER	MODEL	CODE	€	CODE	€
PureSteam boiler	Solid iWash	●	CPW-0623-E R SW S	19073931	-	-	-
		-	CPW-0623-E R SW	19107065	-	-	-
	Spray mode	●	CP-0623-E R S	19096907	-	-	-
		-	CP-0623-E R	19098462	-	-	-
DirectSteam injection	Solid iWash	●	CW-0623-E R SW S	19107169	-	-	-
		-	CW-0623-E R SW	19075070	-	-	-
	Spray mode	●	C-0623-E R S	19107168	-	-	-
		-	C-0623-E R	19075013	-	-	-

## Configurable options

OPTION	NAMING	DESCRIPTION	CONF. CODE	€
Washing	LW*	Liquid iWash *Only available for models with W	0107-0001	-
OPCIONES DE VOLTAJE			CONF. CODE	€
	230V 3~ 50/60Hz		0102-0061	-
	230V 1N 50/60Hz		0102-0062	-
	Marine 440V 3~ 50/60Hz *	*External module, not integrated in the oven	0102-0063	-

## Accessories 0623

EXTRACTION	MODEL	CONDENSATION HOOD	ACTIVATED CARBON FILTER	HEIGHT (mm)	CODE	€	
	EXH-23	x	-	255	19073213	-	
	EXH-23-CA	x	x	330	19103376	-	
	FCA	Replacement for activated carbon filter of EXH-23 CA			19107067	-	
	Kit EXT-23	Extraction kit for EXH-23 hoods			19096418	-	
	STANDS	MODEL	RACKS (SPACING)	WHEELS	HEIGHT (mm)	CODE	€
	SH-23	-	-	-	850	19103553	-
	SH-23-R	-	-	x	850	19103554	-
	SH-23-B	2 x 6 GN2/3 (68mm)	-	-	850	19103555	-
	SH-23-RB	2 x 6 GN2/3 (68mm)	-	x	850	19103556	-
	SH-23-RBM	Mobile stand with 2 x 1.5l bottles for clean water and drainage	-	x	850	19103256	-
	SHP-23	Wall support for 0623 ovens				19103257	-
	MSH-23	Levelling support to place a 0623 oven on a cabinet or stand			19103319	-	
FASTENING KIT	MODEL	DESCRIPTION			CODE	€	
	Kit A-23	Fastening kit for 0623 ovens			19106481	-	

x Included

- Not included

For more accessories, check 'other accessories' chapter

## CONCEPT

## iKORE 061

## PureSteam or DirectSteam



General information		Version	
FIELD	DATA	ELECTRIC (E)	NATURAL GAS (G)
Capacity (standard)	Racks and tray type	6 GN1/1	6 GN1/1
	Spacing between rack rails	68mm	68mm
Energy supply (standard)	Electric / gas power	11,1 kW	0,83 kW / 12 kW
	Frecuency	50/60 Hz	50 Hz
	Voltage	380-415V 3N	230V 1N
Dimensions and weight	Width	895mm	895mm
	Depth (with handle)	817mm (883mm)	817mm (883mm)
	Gas with boiler versions	-	922mm (988mm)
	Height (with hinge)	846mm (877mm)	846mm (877mm)
	Net weight (gross)	~118,5Kg (145Kg)	~146Kg (162,5Kg)

## Codes and prices

HUMIDITY	WASHING	SHOWER	MODEL	CODE	€	CODE	€
PureSteam boiler	Solid iWash	•	CPW-061-(E/G) R SW S	19073648	-	19088202	-
		-	CPW-061-(E/G) R SW	19107352	-	19107353	-
	Spray mode	•	CP-061-(E/G) R S	19096875	-	19096877	-
		-	CP-061-(E/G) R	19098464	-	19107350	-
DirectSteam injection	Solid iWash	•	CW-061-(E/G) R SW S	19107357	-	19107356	-
		-	CW-061-(E/G) R SW	19076322	-	19088201	-
	Spray mode	•	C-061-(E/G) R S	19107354	-	19107355	-
		-	C-061-(E/G) R	19074625	-	19088200	-

## Configurable options

OPTION	NAMING	DESCRIPTION	CONF. CODE	€
Opening	L	Inverted opening with door hinge on left-hand side	0103-0001	-
Washing	LW*	Liquid iWash *Only available for models with W	0107-0001	-

VOLTAGE OPTIONS	CONF. CODE	€
230V 3~ 50/60Hz	0102-0001	-
230V 1N 50/60Hz	0102-0002	-
Marine 440V 3~ 50/60Hz	0102-0003	-
230V 1N 60Hz	0102-0007	-
230V 2~ 50Hz	0102-0008	-
230V 2~ 60Hz	0102-0009	-

GAS OPTIONS	CONF. CODE	€
Butane-Propane LPG	0101-0001	-
Town gas TG	0101-0002	-

## Accessories 061

EXTRACCIÓN	MODEL	CONDENSATION HOOD	ACTIVATED CARBON FILTER	LEFT OPENING (L)	HEIGHT (mm)				CODE	€
	EXH-11	x	-	-	303	x	-	-	19085190	-
	EXH-11 L	x	-	x	303	x	-	-	19103220	-
	EXH-11-CA	x	x	-	363	x	-	-	19103393	-
	EXH-11-CA L	x	x	x	363	x	-	-	19104232	-

FCA	Replacement for activated carbon filter of EXH-11 CA		x	-	-	-	-	-	19107067	-
	Kit EXT-11	Extraction kit for EXH-11 hoods		x	-	-	-	-	19096417	-
	Kit CTG-11	Flue gas exhaust stack for 061 ovens		-	x	x	x	-	19095581	-

STANDS	MODEL	RACKS ( SPACING)	WHEELS	DOORS	HEIGHT (mm)				CODE	€
	SH-11-65	-	-	-	650	x	x	-	19082326	-
								x	19082327	-
	SH-11-65 R	-	x	-	650	x	x	-	19083237	-
								x	19083234	-
	SH-11-65 B	2 x 6 GN1/1 (68mm)	-	-	650	x	x	-	19082006	-
								x	19082005	-
	SH-11-65 BR	2 x 6 GN1/1 (68mm)	x	-	650	x	x	-	19083238	-
								x	19083239	-
	SH-11- 65 BCP	2 x 6 GN1/1 (68mm)	-	x	650	x	x	-	19079211	-
								x	19079233	-
	SH-11-85	-	-	-	850	x	x	-	19103370	-
								x	19103413	-
	SH-11-85 R	-	x	-	850	x	x	-	19103373	-
								x	19103415	-
	SH-11-85 B	2 x 6 GN1/1 (68mm)	-	-	850	x	x	-	19103369	-
								x	19103442	-
	SH-11-85 BR	2 x 6 GN1/1 (68mm)	x	-	850	x	x	-	19103381	-
								x	19103443	-

STRUCTURES	MODEL	RACKS ( SPACING)				CODE	€
	EB-061*	Mobile rack for 6 GN1/1 trays (62mm)	x	x	x	19011559	-

	EP-061*	Mobile rack for 18 plates Ø31 (64mm) * GE-11 and CP-11(-R) required	x	x	x	19013353	-
--	---------	--	---	---	---	----------	---

TROLLEYS	MODEL	DESCRIPTION				CODE	€
	GE-11	Structure rack for EB-061 and EP-061	x	x	x	19011569	-
	CP-11	Structure support trolley for oven on SH-11-65	x	x	x	19013352	-
	CP-11-R	Adjustable structure support trolley for oven on SH-11	x	x	x	19018752	-

PLINTH	MODEL	DESCRIPTION				CODE	€
	Kit Z-11	Plinth kit	x	x	-	19087303	-
			-	-	x	19087305	-

x Included - Not included

For more accessories, check 'other accessories' chapter

For electric ovens only

For gas ovens only

Only for gas ovens with boiler: APW-061-G



## CONCEPT

## iKORE 101

## PureSteam or DirectSteam



General information		Version	
FIELD	DATA	ELECTRIC (E)	NATURAL GAS (G)
Capacity (standard)	Racks and tray type	10 GN1/1	10 GN1/1
	Spacing between rack rails	68mm	68mm
Energy supply (standard)	Electric / gas power	18,6 kW	0,83 kW / 18 kW
	Frecuency	50/60 Hz	50 Hz
	Voltage	380-415V 3N	230V 1N
Dimensions and weight	Width	895mm	895mm
	Depth (with handle)	817mm (883mm)	817mm (883mm)
	Gas with boiler versions	-	922mm (988mm)
	Height (with hinge)	1117mm (1149mm)	1117mm (1149mm)
	Net weight (gross)	~139Kg (174Kg)	~162Kg (197Kg)

## Codes and prices

HUMIDITY	WASHING	SHOWER	MODEL	CODE	€	CODE	€
PureSteam boiler	Solid iWash	●	CPW-101-(E/G) R SW S	19072806	-	19088212	-
		-	CPW-101-(E/G) R SW	19107359	-	19107360	-
	Spray mode	●	CP-101-(E/G) R S	19096891	-	19096893	-
		-	CP-101-(E/G) R	19098465	-	19107358	-
DirectSteam injection	Solid iWash	●	CW-101-(E/G) R SW S	19107363	-	19107364	-
		-	CW-101-(E/G) R SW	19073625	-	19088211	-
	Spray mode	●	C-101-(E/G) R S	19107361	-	19107362	-
		-	C-101-(E/G) R	19078439	-	19088210	-

## Configurable options

OPTION	NAMING	DESCRIPTION	CONF. CODE	€
Opening	L	Inverted opening with door hinge on left-hand side	0103-0001	-
Washing	LW*	Liquid iWash *Only available for models with W	0107-0001	-

VOLTAGE OPTIONS	CONF. CODE	€
230V 3~ 50/60Hz	0102-0021	-
Marine 440V 3~ 50/60Hz	0102-0023	-
230V 1N 60Hz	0102-0027	-
230V 2~ 50Hz	0102-0028	-
230V 2~ 60Hz	0102-0029	-

GAS OPTIONS	CONF. CODE	€
Butane-Propane LPG	0101-0001	-
Gas villa TG (Town gas)	0101-0002	-

## Accessories 101

EXTRACTION	MODEL	CONDENSATION HOOD	ACTIVATED CARBON FILTER	LEFT OPENING (L)	HEIGHT (mm)				CODE	€
	EXH-11	x	-	-	303	x	-	-	19085190	-
	EXH-11 L	x	-	x	303	x	-	-	19103220	-
	EXH-11-CA	x	x	-	363	x	-	-	19103393	-
	EXH-11-CA L	x	x	x	363	x	-	-	19104232	-

FCA	Replacement for activated carbon filter of EXH-11 CA		x	-	-	-	-	-	19107067	-
	Kit EXT-11	Extraction kit for EXH-11 hoods		x	-	-	-	-	19096417	-
	Kit CTG-11	Flue gas exhaust stack for 061 ovens		-	x	x	x	-	19095581	-

STANDS	MODEL	RACKS ( SPACING)	WHEELS	DOORS	HEIGHT (mm)				CODE	€
	SH-11-65	-	-	-	650	x	x	-	19082326	-
						-	-	x	19082327	-
	SH-11-65 R	-	x	-	650	x	x	-	19083237	-
						-	-	x	19083234	-
	SH-11-65 B	2 x 6 GN1/1 (68mm)	-	-	650	x	x	-	19082006	-
						-	-	x	19082005	-
	SH-11-65 BR	2 x 6 GN1/1 (68mm)	x	-	650	x	x	-	19083238	-
						-	-	x	19083239	-
	SH-11- 65 BCP	2 x 6 GN1/1 (68mm)	-	x	650	x	x	-	19079211	-
						-	-	x	19079233	-
	SH-11-85	-	-	-	850	x	x	-	19103370	-
						-	-	x	19103413	-
	SH-11-85 R	-	x	-	850	x	x	-	19103373	-
						-	-	x	19103415	-
	SH-11-85 B	2 x 6 GN1/1 (68mm)	-	-	850	x	x	-	19103369	-
						-	-	x	19103442	-
	SH-11-85 BR	2 x 6 GN1/1 (68mm)	x	-	850	x	x	-	19103381	-
						-	-	x	19103443	-

STRUCTURES	MODEL	RACKS ( SPACING)				CODE	€
	EB-101*	Mobile rack for 10 GN1/1 trays (62mm)	x	x	x	19011561	-
	EP-101*	Mobile rack for 30 plates Ø31 (64mm) * GE-11 and CP-11(-R) required	x	x	x	19013354	-

TROLLEYS	MODEL	DESCRIPTION				CODE	€
	GE-11	Structure rack for EB-061 and EP-061	x	x	x	19011569	-
	CP-11	Structure support trolley for oven on SH-11-65	x	x	x	19013352	-
	CP-11-R	Adjustable structure support trolley for oven on SH-11	x	x	x	19018752	-

PLINTH	MODEL	DESCRIPTION				CODE	€
	Kit Z-11	Plinth kit	x	x	-	19087303	-
			-	-	x	19087305	-

x Included - Not included

For more accessories, check 'other accessories' chapter

For electric ovens only

For gas ovens only

Only for gas ovens with boiler: APW-101-G

## CONCEPT

## iKORE 062

## PureSteam or DirectSteam



General information		Version	
FIELD	DATA	ELECTRIC (E)	NATURAL GAS (G)
Capacity (standard)	Racks and tray type	6 GN2/1	Version no disponible
	Spacing between rack rails	68mm	-
Energy supply (standard)	Electric / gas power	22,2 kW	-
	Frecuency	50/60 Hz	-
	Voltage	380-415V 3N	-
	Width	1134mm	-
Dimensions and weight	Depth (with handle)	1066mm (1134mm)	-
	Height (with hinge)	846mm (877mm)	-
	Net weight (gross)	~190Kg (220Kg)	-

Codes and prices							
HUMIDITY	WASHING	SHOWER	MODEL	CODE	€	CODE	€
PureSteam boiler	Solid iWash	●	CPW-062-E R SW S	19087480	-	-	-
		-	CPW-062-E R SW	19107366	-	-	-
	Spray mode	●	CP-062-E R S	19096879	-	-	-
		-	CP-062-E R	19107365	-	-	-
DirectSteam injection	Solid iWash	●	CW-062-E R SW S	19107368	-	-	-
		-	CW-062-E R SW	19088207	-	-	-
	Spray mode	●	C-062-E R S	19107367	-	-	-
		-	C-062-E R	19088206	-	-	-

Configurable options				
OPTION	NAMING	DESCRIPTION	CONF. CODE	€
Opening	L	Inverted opening with door hinge on left-hand side	0103-0001	-
Washing	LW*	Liquid iWash *Only available for models with W	0107-0001	-

VOLTAGE OPTIONS			CONF. CODE	€
	230V 3~ 50/60Hz		0102-0011	-
	Marine 440V 3~ 50/60Hz		0102-0013	-

## Accessories 062

STANDS	MODEL	RACKS ( SPACING)	WHEELS	DOORS	HEIGHT (mm)	CODE	€
	SH-21-65	-	-	-	650	19084190	-
	SH-21-65 R	-	x	-	650	19084191	-
	SH-21-65 B	6 GN1/1 + 6 GN2/1 (68mm)	-	-	650	19083224	-
	SH-21-65 BR	6 GN1/1 + 6 GN2/1 (68mm)	x	-	650	19084192	-
	SH-21-65 BCP	6 GN1/1 + 6 GN2/1 (68mm)	-	x	650	19082394	-
	SH-21-85	-	-	-	850	19103382	-
	SH-21-85 R	-	x	-	850	19103383	-
	SH-21-85 B	6 GN1/1 + 6 GN2/1 (68mm)	-	-	850	19103384	-
	SH-21-85 BR	6 GN1/1 + 6 GN2/1 (68mm)	x	-	850	19103385	-
STRUCTURES	MODEL	RACKS ( SPACING)			CODE	€	
	EB-062*	Mobile rack for 6 GN2/1 trays (62mm)			19095517	-	
	EP-062*	Mobile rack for 28 plates Ø31 (75mm) * GE-21 and CP-21(-R) required			19095518	-	
TROLLEYS	MODEL	DESCRIPTION			CODE	€	
	GE-21	Structure rack for EB-062 and EP-062			19011570	-	
	CP-21	Structure support trolley for oven on SH-21			19013355	-	
	CP-21-R	Adjustable structure support trolley for oven on SH-21			19018751	-	
PLINTH	MODEL	DESCRIPTION			CODE	€	
	Kit Z-21	Plinth kit			19087306	-	

x Included - Not included

For more accessories, check 'other accessories' chapter

## CONCEPT

## iKORE 102

## PureSteam o DirectSteam

FagorDial  
2.8"

General information		Version	
FIELD	DATA	ELECTRIC (E)	NATURAL GAS (G)
Capacity (standard)	Racks and tray type	10 GN2/1 (20 GN1/1)	10 GN2/1 (20 GN1/1)
	Spacing between rack rails	68mm	68mm
	Electric / gas power	33,6 kW	0,83 kW / 35 kW
Energy supply (standard)	Frecuency	50/60 Hz	50 Hz
	Voltage	380-415V 3N	230V 1N
Dimensions and weight	Width	1134mm	1134mm
	Depth (with handle)	1066mm (1134mm)	1066mm (1134mm)
	Height (with hinge)	1117mm (1149mm)	1117mm (1149mm)
	Net weight (gross)	~217Kg (258Kg)	~230Kg (265,5Kg)

Codes and prices							
HUMIDITY	WASHING	SHOWER	MODEL	CODE	€	CODE	€
PureSteam boiler	Solid iWash	•	CPW-102-(E/G) R SW S	19079303	-	19088218	-
		-	CPW-102-(E/G) R SW	19107371	-	19107372	-
	Spray mode	•	CP-102-(E/G) R S	19096895	-	19096897	-
		-	CP-102-(E/G) R	19107369	-	19107370	-
DirectSteam injection	Solid iWash	•	CW-102-(E/G) R SW S	19107455	-	19107456	-
		-	CW-102-(E/G) R SW	19079564	-	19088217	-
	Spray mode	•	C-102-(E/G) R S	19107348	-	19107349	-
		-	C-102-(E/G) R	19079594	-	19088216	-

Configurable options				
OPTION	NAMING	DESCRIPTION	CONF. CODE	€
Opening	L	Inverted opening with door hinge on left-hand side	0103-0001	-
Washing	LW*	Liquid iWash *Only available for models with W	0107-0001	-

OPCIONES DE VOLTAJE	CÓD. CONFIG.	€
230V 3~ 50/60Hz	0102-0031	-
Marine 440V 3~ 50/60Hz	0102-0033	-
230V 1N 60Hz	0102-0037	-
230V 2~ 50Hz	0102-0038	-
230V 2~ 60Hz	0102-0039	-

VOLTAGE OPTIONS	CONF. CODE	€
Butane-Propane LPG	0101-0001	-
Town gas TG	0101-0002	-

## Accessories 102

EXTRACTION	MODEL	DESCRIPTION	CODE	€			
	Kit CTG-12*	Flue gas discharge stack 102 * For gas ovens only	19095590	-			
STANDS	MODEL	RACKS ( SPACING)	WHEELS	DOORS	HEIGHT (mm)	CODE	€
	SH-21-65	-	-	-	650	19084190	-
	SH-21-65 R	-	x	-	650	19084191	-
	SH-21-65 B	6 GN1/1 + 6 GN2/1 (68mm)	-	-	650	19083224	-
	SH-21-65 BR	6 GN1/1 + 6 GN2/1 (68mm)	x	-	650	19084192	-
	SH-21-65 BCP	6 GN1/1 + 6 GN2/1 (68mm)	-	x	650	19082394	-
	SH-21-85	-	-	-	850	19103382	-
	SH-21-85 R	-	x	-	850	19103383	-
	SH-21-85 B	6 GN1/1 + 6 GN2/1 (68mm)	-	-	850	19103384	-
	SH-21-85 BR	6 GN1/1 + 6 GN2/1 (68mm)	x	-	850	19103385	-
STRUCTURES	MODEL	RACKS ( SPACING)	CODE	€			
	EB-102*	Mobile rack for 10 GN2/1 trays (62mm)	19011562	-			
	EP-102*	Mobile rack for 52 plates Ø31 (75mm) * GE-21 and CP-21(-R) required	19013356	-			
TROLLEYS	MODEL	DESCRIPTION	CODE	€			
	GE-21	Structure rack for EB-102 and EP-102	19011570	-			
	CP-21	Structure support trolley for oven on SH-21	19013355	-			
	CP-21-R	Adjustable structure support trolley for oven on SH-21	19018751	-			
PLINTH	MODEL	DESCRIPTION	CODE	€			
	Kit Z-21	Plinth kit	19087306	-			

x Included - Not included

For more accessories, check 'other accessories' chapter

## CONCEPT

## iKORE 201

## PureSteam or DirectSteam



General information		Version	
FIELD	DATA	ELECTRIC (E)	NATURAL GAS (G)
Capacity (standard)	Racks and tray type of trolley (T)*	20 GN1/1	20 GN1/1
	Spacing between rack rails	63mm	63mm
Energy supply (standard)	Electric / gas power	37,2 kW	1,55 kW / 36 kW
	Frecuency	50/60 Hz	50 Hz
	Voltage	380-415V 3N	230V 1N
Dimensions and weight	Width	935mm	935mm
	Depth (with handle)	966mm (1032mm)	966mm (1032mm)
	Height (with hinge)	1840mm (1871mm)	1840mm (1871mm)
	Net weight (gross)	~272,5Kg (331,5Kg)	~309Kg (341,5Kg)

Codes and prices							
HUMIDITY	WASHING	SHOWER	MODEL	CODE	€	CODE	€
PureSteam boiler	Solid iWash	●	CPW-201-(E/G) R SW T	19078184	-	19088259	-
		-	CPW-201-(E/G) R SW T	19107458	-	19107459	-
	Spray mode	●	CP-201-(E/G) R S T	19096899	-	19096901	-
		-	CP-201-(E/G) R T	19098466	-	19107457	-
DirectSteam injection	Solid iWash	●	CW-201-(E/G) R SW S T	19107462	-	19107463	-
		-	CW-201-(E/G) R SW T	19079085	-	19091665	-
	Spray mode	●	C-201-(E/G) R S T	19107460	-	19107461	-
		-	C-201-(E/G) R T	19079327	-	19088257	-

Configurable options				
OPTION	NAMING	DESCRIPTION	CONF. CODE	€
Washing	LW*	Liquid iWash *Only available for models with W	0107-0001	-
Trolley	Special T	Consult for other trolley configurations	-	Consult

VOLTAGE OPTIONS	CONF. CODE	€
230V 3~ 50/60Hz	0102-0041	-
Marine 440V 3~ 50/60Hz	0102-0043	-
230V 1N 60Hz	0102-0047	-
230V 2~ 50Hz	0102-0048	-
230V 2~ 60Hz	0102-0049	-

GAS OPTIONS	CONF. CODE	€
Butane-Propane LPG	0101-0001	-
Town gas TG	0101-0002	-

## Accessories 201

EXTRACTION	MODEL	DESCRIPTION	CODE	€
	Kit CTG-21*	Flue gas discharge stack for 201 *For gas ovens only	19095591	-
TROLLEYS	MODEL	RACKS (SPACING)	CODE	€
	CEB-201	20 GN1/1 (63mm)	19011551	-
	CEB-201-69	18 GN1/1 (69mm)	19103883	-
	CEB-201-80	16 GN1/1 (80mm)	19107454	-
	CEB-201-85	15 GN1/1 (85mm)	19107590	-
	CEP-201	50 plates Ø31 (75mm)	19013357	-
RAMP	MODEL	DESCRIPTION	CODE	€
	RH-201	Levelling ramp for 201 trolley	19044716	-
FASTENING KIT	MODEL	DESCRIPTION	CODE	€
	Kit A-20	Floor fastening kit for 201 ovens	19012270	-
KIT HANDLE	MODEL	DESCRIPTION	CODE	€
	Kit ASA	Side support kit for trolley handle	19087163	-

x Included - Not included

For more accessories, check 'other accessories' chapter









## CONCEPT

## iKORE 202





## PureSteam or DirectSteam



General information		Version	
FIELD	DATA	 ELECTRIC (E)	 NATURAL GAS (G)
Capacity (standard)	Racks and tray type of trolley (T)*	20 GN2/1 (40 GN1/1)	20 GN2/1 (40 GN1/1)
	Spacing between rack rails	63mm	63mm
Energy supply (standard)	Electric / gas power	67,2 kW	1,55 kW / 65 kW
	Frecuency	50/60 Hz	50 Hz
	Voltage	380-415V 3N	230V 1N
Dimensions and weight	Width	1165mm	1165mm
	Depth (with handle)	1074mm (1140mm)	1074mm (1140mm)
	Height (with hinge)	1840mm (1871mm)	1840mm (1871mm)
	Net weight (gross)	~338Kg (403,5Kg)	~357Kg (422,5Kg)

Codes and prices							
HUMIDITY	WASHING	SHOWER	MODEL	 CODE	€	 CODE	€
 PureSteam boiler	Solid iWash	•	CPW-202-(E/G) R SW S T	19075005	-	19088276	-
		-	CPW-202-(E/G) R SW T	19107465	-	19107466	-
	Spray mode	•	CP-202-(E/G) R S T	19096903	-	19096905	-
		-	CP-202-(E/G) R T	19098472	-	19107464	-
 DirectSteam injection	Solid iWash	•	CW-202-(E/G) R SW S T	19107469	-	19107480	-
		-	CW-202-(E/G) R SW T	19078517	-	19091669	-
	Spray mode	•	C-202-(E/G) R S T	19107467	-	19107468	-
		-	C-202-(E/G) R T	19078544	-	19088274	-

Configurable options				
OPTION	NAMING	DESCRIPTION	CONF. CODE	€
Washing	LW*	Liquid iWash *Only available for models with W	0107-0001	-
Trolley	Special T	Consult for other trolley configurations	-	consult

VOLTAGE OPTIONS	CONF. CODE	€
 230V 3~ 50/60Hz	0102-0051	-
 Marine 440V 3~ 50/60Hz	0102-0053	-
 230V 1N 60Hz	0102-0057	-
 230V 2~ 50Hz	0102-0058	-
 230V 2~ 60Hz	0102-0059	-

GAS OPTIONS	CONF. CODE	€
Butane-Propane LPG	0101-0001	-
Town gas TG	0101-0002	-

## Accessories 202

EXTRACTION	MODEL	DESCRIPTION	CODE	€
	 Kit CTG-22*	Flue gas discharge stack for 202 *For gas ovens only	19095592	-
TROLLEYS	MODEL	RACKS (SPACING)	CODE	€
	CEB-202	20 GN2/1 (63mm)	19011550	-
	CEB-202-69	18 GN2/1 (69mm)	19103884	-
	CEB-202-80	16 GN2/1 (80mm)	19107481	-
	CEB-202-85	15 GN2/1 (85mm)	19107588	-
	CEP-202- 90	90 plates Ø31 (75mm)	19081933	-
	CEP-202	100 plates Ø31 (75mm)	19011552	-
RAMP	MODEL	DESCRIPTION	CODE	€
	RH-202	Levelling ramp for 202 trolley	19034438	-
FASTENING KIT	MODEL	DESCRIPTION	CODE	€
	Kit A-20	Floor fastening kit for 202 ovens	19012270	-
KIT HANDLE	MODEL	DESCRIPTION	CODE	€
	Kit ASA	Side support kit for trolley handle	19087163	-

x Included - Not included

For more accessories, check 'other accessories' chapter

# Vacuum packers



## General characteristics

### Construction:

- AISI 304
- Busch pumps
- 2 units of high-quality polycarbonate fill sheets
- Protection against water
- Cable-free sealing bars with pneumatic pistons

### Control:

- High-precision microprocessor which controls the vacuum percentage of the chamber
- Digital control panel with display included
- Alarms for set vacuum level and oil change
- Visualisation of the complete machine cycles
- Oil level viewer.

### Functions and programmes:

- Automatic start of the vacuum cycle
- Piston with dual position (operating and idle)
- Easily programmable memory for 10 programmes
- Possibility of performing additional 60" vacuum
- Possibility of packaging liquids
- H2Oout programme to dehumidify the pump
- Programme for external packing both in bags and containers
- The G models make it possible to package delicate or soft products.

### Tabletop vacuum packing

POSITION OF SEALING BAR	MODEL	CODE	BAR LENGTH (mm)	PUMP CAPACITY (m3/h9)	CHAMBER (mm)	POWER (kW)	DIMENSIONS (mm)	€
	SVS-1-310/8	19107730	310	8	332 x 335 x 170	600	395 x 490 x 374	-
	SVS-1-310/8 G	19107731	310	8	332 x 335 x 170	600	395 x 490 x 374	-
	SVS-1-410/10	19107732	410	10	441 x 449 x 170	750	535 x 591 x 438	-
	SVS-1-410/10 G	19107733	410	10	441 x 449 x 170	1000	535 x 591 x 438	-
	SVS-1-410/20	19107734	410	20	441 x 449 x 170	1000	535 x 591 x 438	-
	SVS-1-410/20 G	19107735	410	20	441 x 449 x 170	1000	535 x 591 x 438	-
	SVS-2-410/20	19107736	410 + 410	20	441 x 449 x 170	1000	535 x 591 x 438	-
	SVS-2-410/20 G	19107737	410 + 410	20	441 x 449 x 170	1000	535 x 591 x 438	-

### Floor-standing vacuum packing

*POSITION OF SEALING BAR	MODEL	CODE	BAR LENGTH (mm)	PUMP CAPACITY (m3/h9)	CHAMBER (mm)	POTENCIA (kW)	DIMENSIONES (mm)	€
	SVP-2-455/25	19107738	455 + 455	25	485 x 550 x 175	1200	600 x 710 x 1035	-
	SVP-2-455/25 G	19107740	455 + 455	25	485 x 550 x 175	1200	600 x 710 x 1035	-
	SVP-2-620/63	19107745	620 + 620	63	650 x 535 x 200	1500	765 x 710 x 1050	-
	SVP-2-620/63 G	19107746	620 + 620	63	650 x 535 x 200	1500	765 x 710 x 1050	-
	SVP-2-950/100	19107751	950 + 950	100	980 x 585 x 230	2500	1100 x 800 x 1070	-
	SVP-2-950/100 G	19107752	950 + 950	100	980 x 585 x 230	2500	1100 x 800 x 1070	-
	SVP-2-520/25	19107741	520 + 520	25	485 x 550 x 175	1200	600 x 710 x 1035	-
	SVP-2-520/25 G	19107742	520 + 520	25	485 x 550 x 175	1200	600 x 710 x 1035	-
	SVP-2-505/63	19107743	505 + 505	63	650 x 535 x 200	1500	765 x 710 x 1050	-
	SVP-2-505/63 G	19107744	505 + 505	63	650 x 535 x 200	1500	765 x 710 x 1050	-
	SVP-2-560/100	19107747	560 + 560	100	980 x 585 x 230	2500	1100 x 800 x 1070	-
	SVP-2-560/100 G	19107750	560 + 560	100	980 x 585 x 230	2500	1100 x 800 x 1070	-

G: Models with inert gas inlet

## Accessories for vacuum packaging machines

### Trolleys for tabletop models

CODE	SUITABLE FOR MODELS	DESCRIPTION	€
19076888	SVS-1-310/8	Trolley with 4 wheels 590x550x610h mm	-
19076889	SVS-1-410/10 SVS-1-410/20	Trolley with 4 wheels 690x730x610h mm	-

### Tilted flat shelves for packaging liquids

CODE	SUITABLE FOR MODELS	DESCRIPTION	€
19076890	SVS-1-310/8	Stainless steel tilted flat shelf for packaging liquids	-
19076891	SVS-1-410/10 SVS-1-410/20	Stainless steel tilted flat shelf for packaging liquids	-
19076892	SVP-2-520/25	Stainless steel tilted flat shelf for packaging liquids	-
19076893	SVP-2-620/63	Stainless steel tilted flat shelf for packaging liquids	-
19076897		Stainless steel filter for liquids	-

### Suction tube for emptying into containers

CODE	DESCRIPTION	€
19076894	Suction tube for emptying into external containers	-

### SYV valve for core temperature probe

CODE	DESCRIPTION	€
19076895	Core temperature probe for vacuum cooking inox.	-
19076896	Set of valve seals (10 pieces)	-

# Stacking solutions



## General characteristics

- The kits for ovens in column are composed of a set of parts which allows the ovens to be positioned one above another
- This type of assembly is carried out with 1/1 tray ovens, from any of the three electric ranges.
- The codes of the two ovens must be specified when placing the order, as well as the code of the kit of parts to carry out the assembly in column
- **Fagor Professional supplies the column of ovens ready assembled and finished from the factory.**

MODEL	DESCRIPTION	CODE	€
K-61-61	Stacking kit for 2 iKORE Kompact 061 ovens.	19107453	-
K-61-101	Stacking kit for 1 iKORE Kompact 061 oven + 1 iKORE Kompact 101 oven	19107452	-
61-61 R	Stacking kit for 2 ovens iKORE 061 right door	19087274	-
61-61 L	Stacking kit for 2 ovens iKORE 061 left door	19087275	-
61-101 R	Stacking kit for 1 oven iKORE 061 + 1 oven iKORE 101 right door	19087272	-
61-101 L	Stacking kit for 1 iKORE 061 oven + 1 oven iKORE 101 left door	19087273	-
62-62 R	Stacking kit for 2 ovens iKORE 062 right door	19087551	-
62-62 L	Stacking kit for 2 ovens iKORE 062 left door	19088030	-
62-102 R	Stacking kit for 1 iKORE 062 oven + 1 oven iKORE 102 right door	19088031	-
62-102 L	Stacking kit for 1 iKORE 062 oven + 1 oven iKORE 102 left door	19088032	-

\* Only available for electric ovens

# Cook&Chill solutions



## General characteristics

- Kit of elements to make a stacking system "Cook & Chill" with an oven and a blast chiller or freezer.
- When ordering a "Cook & Chill" column, the oven code, the chiller code and the code of the corresponding kit of elements for column assembly, or the corresponding code for the most common assemblies, must be specified.
- **Fagor Professional supplies the column of ovens ready assembled and finished from the factory.**

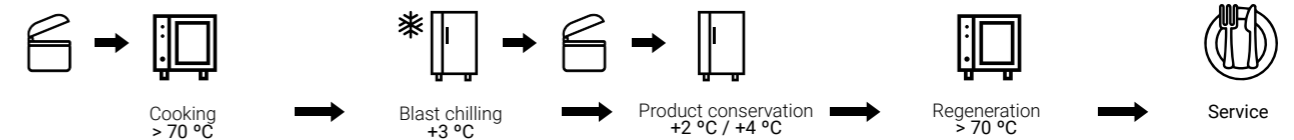

MODEL	DESCRIPTION	CODE	€
KIT C&C-0623	Cook&Chill assembly kit for iKORE 0623 oven + ABCO 0623 blast chiller	19087772	-
KIT C&C-061	Cook&Chill assembly kit for iKORE 061 oven + ABCO 061 blast chiller	19088139	-
KIT C&C-061 G	Cook&Chill assembly kit for iKORE 061 gas oven with boiler + ABCO 061 blast chiller	19095521	-



## The importance of using blast chillers

Blast chillers are machines designed to quickly lower the temperature of food from 90°C after cooking to a refrigeration temperature of +3°C in no more than 90 minutes, thus preventing bacteria from multiplying.

Our different ranges of mixed blast chillers, with built-in freezing cycle, can lower the temperature of the product to -18 °C in a time of 4 hours, thus achieving a very fast freezing of the food, avoiding, in addition to the increase in bacterial flora, the formation of macrocrystals.

# Our Cook&Chill selection

The combined use of ovens and blast chillers allows you to be more efficient, as it makes it easier for you to programme your work in the kitchen.



The correct use of blast chillers with combi ovens results in less waste, time savings and a product that is served at the right time.

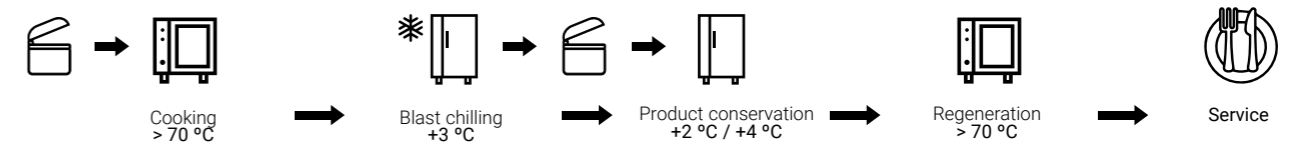

**Cook & Chill 0623**  
30-60 meals per day



Oven + Blast chiller		
MODEL	CODE	€
APW-0623-E R S SW K	19079298	-
Kit C&C-0623	19087772	-
ABCO-06 2/3 50Hz	19087540	-
<b>C&amp;C 0623 Solution</b>		-

**Cook & Chill 061**  
50-100 meals per day



Oven + Blast chiller		
MODEL	CODE	€
APW-061-E R S SW K	19078616	-
Kit C&C-061	19088139	-
ABCO-061 50Hz	19105609	-
<b>C&amp;C 061 Solution</b>		-

**Cook & Chill 101**  
80-150 meals per day



Oven + Stand + Blast chiller		
MODEL	CODE	€
APW-101-E R S SW K	19078668	-
SH-11-65 BCP	19079211	-
ABCO-101 50Hz	19105605	-
<b>C&amp;C 101 Solution</b>		-

**Cook & Chill 102**  
150-250 meals per day



Oven + Stand + Blast chiller		
MODEL	CODE	€
APW-102-E R S SW K	19079785	-
SH-21-65 BCP	19082394	-
ABCO-102 50Hz	19091443	-
<b>C&amp;C 102 Solution singular</b>		-

**Cook & Chill 201**  
150-250 meals per day



Oven + Roll in blast chillers		
MODEL	CODE	€
APW-201-E R S SW T K	19079328	-
RBP-201	19089779	-
<b>C&amp;C 201 Solution singular</b>		-

**Cook & Chill 202**  
200-400 meals per day



Oven + Roll in blast chillers		
MODEL	CODE	€
APW-202-E R S SW T K	19078839	-
RBM-202	19089790	-
<b>C&amp;C 202 Solution singular</b>		-

· Complete your ideal solution with our packaging machines and oven accessories: hoods, trolleys and frames, trays...

· See more blast chiller models in the refrigeration section.

(\*) Without condensing unit.

· Complete your ideal solution with our packaging machines and oven accessories: hoods, trolleys and frames, trays...

· See more blast chiller models in the refrigeration section.

(\*) Without condensing unit.



## Cleaning accessories

### Solid wash SW

	MODEL	DESCRIPTION	CODE	€
	BUCKET OF DETERGENT TABLETS	Bucket of detergent tablets, 75 units	19086761	-
	BUCKET OF RINSE AID TABLETS	Bucket of rinse aid tablets, 75 units	19086763	-
	AB BOOST	Powder detergent- 8kg drum	19086764	-

### Liquid wash LW

	MODEL	DESCRIPTION	CODE	€
	LIQUID DET. 10L	Liquid detergent 10L	19086053	-
	LIQUID R. AID 10L	Liquid rinse aid 10L	19086054	-

### Basic wash - Spray mode

	MODEL	DESCRIPTION	CODE	€
	KOI PLUS	Degreaser- 6kg bottle	19086765	-

### Externa shower

	MODEL	DESCRIPTION	CODE	€
	Shower kit	External shower kit	19004504	-

## Kits (various)

### Double lock

	MODEL	DESCRIPTION	CODE	€
	Kit DC	Double locking anchor kit to open the ovens door in two steps	19069736	-

### Fair kits

	MODEL	DESCRIPTION	CODE	€
	KIT FERIA ADVANCE	ADVANCE dummy hand control kit for trade fairs	19095582	-
	KIT FERIA CONCEPT	CONCEPT dummy hand control kit for trade fairs	19095583	-

### Back-up battery

	MODEL	DESCRIPTION	CODE	€
	Back-up kit	back-up battery kit	19084561	-

### Transformation kits (gas)

	MODEL	DESCRIPTION	CODE	€
	Kit HU-061	Gas transformation kit G25,1 for iKORE 061	19103095	-
	Kit HU-101	Gas transformation kit G25,1 for iKORE 101	19103096	-
	Kit HU-102	Gas transformation kit G25,1 for iKORE 102	19103097	-
	Kit HU-201	Gas transformation kit G25,1 for iKORE 201	19103098	-
	Kit HU-202	Gas transformation kit G25,1 for iKORE 202	19103099	-

## Racks and trolleys BAKE 60/40

### Pastry / bakery frames 600x400mm

RACK	MODEL	DESCRIPTION	OVEN	CODE	€
	GP-061	Rack kit for 5 BAKE 60/40 trays (spacing between rack rails = 85mm)	iKORE 061	19011982	-
	GP-101	Rack kit for 8 BAKE 60/40 trays (spacing between rack rails = 85mm)	iKORE 101	19011983	-
	GP-062	Rack kit for 5 BAKE 60/80 trays (spacing between rack rails = 85mm)	iKORE 062	19095570	-
	GP-102	Rack kit for 8 BAKE 60/80 trays (spacing between rack rails = 85mm)	iKORE 102	19012134	-

### Pastry / bakery trolleys 600x400mm

CARROS	MODEL	DESCRIPTION	OVEN	CODE	€
	CBK-15	Trolley for 15 BAKE 60/40 trays (spacing between rack rails = 85mm)	iKORE 201	19107596	-
	CBK-16	Trolley for 16 BAKE 60/40 trays (spacing between rack rails = 85mm)	iKORE 201	19107668	-
	CBK-30	Trolley for 15 BAKE 60/80 trays (spacing between rack rails = 85mm)	iKORE 202	19107620	-
	CBK-32	Trolley for 16 BAKE 60/80 trays (spacing between rack rails = 85mm)	iKORE 202	19107669	-

## Cooking accessories

### Smoker

	MODEL	POWER (W)	VOLTAGE	HZ	DIMENSIONS (mm)	CODE	€
	SMOKER	250	230V 1N	50/60	95 x 268 x 54	19059112	

### Additional external probe

	MODEL	DESCRIPTION	CODE	€
	Kit SV*	SousVide external temperature control probe kit for vacuum cooking	19059112	
	Kit ST*	External single point temperature control probe kit.	19087746	
	Kit SS	External support for ST and SV probes	19107627	



\***ADVANCE**: possibility of working with an internal probe and up to 2 external probes at the same time (total 3 probes working at the same time) Multitray  
 \***CONCEPT**: possibility of working with an internal or external probe (1 single probe working).

# Gastronorm trays (GN)

## Grid - AISI-304 1mm (EN631)

	MODEL	CAPACITY	DIMENSIONS (WxL)	DEPTH (mm)	CODE	€
	GRID 2/3	-	GN-2/3 (325x354 mm)	-	19058664	-
	GRID 1/1	-	GN-1/1 (325x530 mm)	-	19085067	-
	GRID 2/1	-	GN-2/1 (650x530 mm)	-	19085068	-

## Grills and grease trays

	MODEL	CAPACITY	DIMENSIONS (WxL)	DEPTH (mm)	CODE	€
	PO 1/1-8	8 chickens	GN-1/1 (325x530 mm)	-	19001496	-
	CO 1/1	Ribs	GN-1/1 (325x530 mm)	-	19000545	-
	BRG 1/1	5l	GN-1/1 (325x530 mm)	-	19107594	-
	BRG 2/1	10l	GN-2/1 (650x530 mm)	-	19107615	-

## Flat trays

	MODEL	CAPACITY (l)	DIMENSIONS (WxL)	DEPTH (mm)	CODE	€
	GN 2/3-20	1,70	GN-2/3 (325x354 mm)	20	19058658	-
	GN 2/3-40	3,2	GN-2/3 (325x354 mm)	40	19058659	-
	GN 1/1-20	2,50	GN-1/1 (325x530 mm)	20	19001669	-
	GN 1/1-40	5,50	GN-1/1 (325x530 mm)	40	19048493	-
	GN 1/1-65	9,50	GN-1/1 (325x530 mm)	65	19048494	-
	GN 1/1-100	14,00	GN-1/1 (325x530 mm)	100	19048495	-
	GN 2/1-20	3,00	GN-2/1 (650x530 mm)	20	19001673	-
	GN 2/1-40	10,50	GN-2/1 (650x530 mm)	40	19001674	-
	GN 2/1-65	18,50	GN-2/1 (650x530 mm)	65	19001675	-
	GN 2/1-100	28,00	GN-2/1 (650x530 mm)	100	19001672	-



## Perforated trays

	MODEL	CAPACITY (l)	DIMENSIONS (WxL)	DEPTH (mm)	CODE	€
	GNP 2/3-20	1,7	GN-2/3 (325x354 mm)	20	19058660	-
	GNP 2/3-40	3,2	GN-2/3 (325x354 mm)	40	19058661	-
	GNP 1/1-40	5,5	GN-1/1 (325x530 mm)	40	19001677	-
	GNP 1/1-65	9,5	GN-1/1 (325x530 mm)	65	19048496	-
	GNP 1/1-100	14	GN-1/1 (325x530 mm)	100	19001676	-
	GNP 2/1-40	10,5	GN-2/1 (650x530 mm)	40	19001680	-
	GNP 2/1-65	18,5	GN-2/1 (650x530 mm)	65	19001681	-
	GNP 2/1-100	28	GN-2/1 (650x530 mm)	100	19001679	-

## Granite trays

	MODEL	CAPACITY (l)	DIMENSIONS (WxL)	DEPTH (mm)	CODE	€
	TP 2/3-20	1,7	GN-2/3 (325x354 mm)	20	19058663	-
	TP 2/3-40	3,2	GN-1/1 (325x530 mm)	40	19059569	-
	TP 1/1-20	2,5	GN-1/1 (325x530 mm)	20	19001978	-
	TP 1/1-40	5,5	GN-1/1 (325x530 mm)	40	19001979	-
	TP 1/1-65	9,5	GN-1/1 (325x530 mm)	65	19001980	-
	TP 2/1-20	3,5	GN-2/1 (650x530 mm)	20	19001981	-
	TP 2/1-40	10,5	GN-2/1 (650x530 mm)	40	19001982	-
	TP 2/1-65	18,50	GN-2/1 (650x530 mm)	65	19001983	-

## Pastry trays

	MODEL	CAPACITY	DIMENSIONS (WxL)	DEPTH (mm)	CODE	€
	BPA 2/3 Flat	-	GN-2/3 (325x354 mm)	-	19058657	-
	BPA 1/1 Flat	-	GN-1/1 (325x530 mm)	-	19000313	-
	BPP 2/3 Perforated	-	GN-2/3 (325x354 mm)	-	19058656	-
	BPP 1/1 Perforated	-	GN-1/1 (325x530 mm)	-	19000314	-
	BB 1/1 Baguettes	4 cavities	GN-1/1 (325x530 mm)	-	19107820	-
	BB 60/40 Baguettes	5 cavities	BAKE 60/40 (600x400)	-	19107822	-



## Mould trays

	MODEL	CAPACITY	DIMENSIONS (WxL)	DEPTH (mm)	CODE	€
	MT 2/3 6	6 cavities	GN-2/3 (325x354 mm)	10 Ø x 15H	19107800	-
	MT 1/1 11	11 cavities	GN-1/1 (325x530 mm)	10 Ø x 15H	19107811	-

## Frying trays

	MODEL	CAPACITY	DIMENSIONS (WxL)	DEPTH (mm)	CODE	€
	FRI 2/3	-	GN-2/3 (325x354 mm)	40	19058655	-
	FRI 1/1	-	GN-1/1 (325x530 mm)	40	19012415	-

## Griddle grids to roast or mark

	MODEL	CAPACITY	DIMENSIONS (WxL)	DEPTH (mm)	CODE	€
	MG 2/3	-	GN-2/3 (325x354 mm)	-	19058654	-
	MG 1/1	-	GN-1/1 (325x530 mm)	-	19001460	-
	GRILL 1/1	-	GN-1/1 (325x530 mm)	(Perforated)	19002844	-
	FG 2/3	-	GN-2/3 (325x354 mm)	-	19059568	-
	FG 1/1	-	GN-1/1 (325x530 mm)	-	19076583	-





Dishwashing





## One body, three ranges.

E-VO Generation is a dream come true, and goes one step further: This is a different and innovative generation... Revolutionary.

Because E-VO is built on a unique simple idea: It's creation a single body structure that offers common benefits for its three different ranges: E-VO ADVANCE, E-VO CONCEPT PLUS and E-VO CONCEPT.

**All 3 ranges, advance, concept plus and concept, boast common structural characteristics:**

### Glasswasher



CONCEPT+  
CONCEPT

### Front loading



ADVANCE  
CONCEPT+  
CONCEPT

### Hood-type



ADVANCE  
CONCEPT+  
CONCEPT

- Front-loading glass washers - E-VO Generation.
- Constructed in stainless steel.
- Double wall door.
- Double rotating wash system, top and bottom, in stainless steel except in CO-350 which are made of composite material.
- Double rotating rinse system, top and bottom, made of composite material.
- Rounded tank to facilitate washing and drainage.
- Stainless steel heating elements in the wash tank and rinse boiler.
- Thermostatic control of temperatures (wash 60°C / rinse 85°C).
- Safety thermostat
- Rinse aid doser incorporated.
- Fitted with non-return valve.
- 260 W wash pump
- Water consumption of 2.2 liter per cycle.
- Magnetic safety stop switch in door opening.
- IPX4 anti-humidity protection.

- Front-loading dishwashers - E-VO Generation.
- Constructed in stainless steel.
- Whole body with double wall.
- Counterbalanced door with stainless steel hinges and double spring.
- At 850 mm high meaning the unit can be positioned under a counter.
- Double rotating wash and rinse system, top and bottom, in stainless steel.
- Rounded tank to facilitate washing and drainage.
- Stainless steel heating elements in the wash tank and rinse boiler.
- 380 mm opening door height means GN pans can be washed.
- Thermostatic control of temperatures (wash 60°C / rinse 85°C).
- 600 W wash pump with SOFT-START.
- Water consumption of 2.4 liter per cycle.
- Rinse aid doser incorporated.
- Magnetic safety stop switch in door opening.
- Safety thermostat.
- Model for 500 x 500 mm baskets.
- Hood-Type dishwashers - E-VO Generation.

- Constructed in stainless steel.
- Counterbalanced hood with handle and spring system.
- Double rotating wash and rinse system, top and bottom, in stainless steel.
- 440 mm hood opening (Accepts GN 1/1 trays).
- 750 W wash pump providing high water flow.
- Rounded tank to facilitate washing and drainage.
- Stainless steel heating elements in the wash tank and rinse boiler.
- Multi-voltage: Allows the machine to be connected to a single-phase or three-phase voltage network. (230 1N~/230 3~/400V 3N~).
- AISI-304 stainless steel filter trays in the wash tank.
- Thermostatic control of temperatures (wash 60°C / rinse 85°C).
- Thermal stop system which guarantees a rinse temperature of 85°C.
- Safety stop switch in hood opening.
- Safety thermostat.
- Water consumption of 2.4 liter per cycle.
- Model for 500 x 500 mm baskets.

	GLASSWASHER			FRONT LOADING			HOOD-TYPE		
	CONCEPT+	CONCEPT	CONCEPT	ADVANCE	CONCEPT+	CONCEPT	ADVANCE	CONCEPT+	CONCEPT
Basket Size	400x400	400x400	350x350	500x500	500x500	500x500	500x500	500x500	500x500
CONTROL PANEL									
				AD-505			AD-125		
	With rinsing pump	COP-404		COP-504			COP-144		
	Without rinsing pump	CO-402		CO-502			CO-142		
	Multi - power			CO-501			CO-110		
	Single phase	CO-400	CO-350	CO-500					



# Glasswasher

Concept + .....	177
Concept .....	178
Accessories .....	182

**Water connection:**  
It is advisable to introduce sanitary water in the dishwashers, with a temperature of 50 - 60 °C.

**Water pressure:**  
Minimum: 2 bar = 2 kg/cm<sup>2</sup>  
Maximum: 4 bar = 4 kg/cm<sup>2</sup>

**Water softener:**  
All glass / dishwashers should be connected to a treated water supply when the local supply is over 10 HF / 6 HD.

Any issues derived from a bad installation that don't meet with the indicated conditions will not be considered as a warranty.



The small and versatile solution for sparkling results.



Access the website



Sales brochure



# Glasswashers

EFFI  
RINSE230 V  
1 N

## General characteristics

- Electronic control and display of temperature, functions and errors.
- Control with help system for technical service.
- Thermostop system with rinse pump that guarantees a perfect hygienic result with a complete Glasswashing rinse temp at 63 degrees (EFFIRINSE) in accordance with the safety and hygiene specifications of standard DIN10512.
- Air Break check valve system type AA according to EN 1717/WRAS.
- Model for 400 x 400 mm baskets.
- 90s - 120s - 180s wash cycles and maximum production of 40 baskets/hour.
- Useful internal height of 270 mm.
- Tank with volume of 15 litres, with 2 kW heating element.
- Boiler with volume of 4 litres, with 2.8 kW heating element.

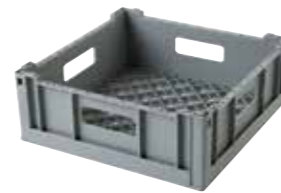
Basket  
400 x 400 mm

	MODEL	CODE 50 HZ.*	€
<b>CHARACTERISTICS</b>			
<b>Basic model</b>	<b>COP-404</b>	<b>19073733</b>	-
Rinse pump			
Voltage	230 V / 1N		
Power (kW)	3,06		
Dimensions (mm)	470x525x720		
<b>Versions</b>			
Drainage pump	B	COP-404 B	19075262
Peristaltic detergent doser	DD	COP-404 DD	19075263
Drainage pump and peristaltic detergent doser	B - DD	COP-404 B DD	19075264

\* Consult other possible factory versions.

<b>ACCESORIES</b>	
Stands	See page. 182
Conversion kits	See page. 182
Water softeners	See page. 204
Osmosis	See page. 204
Baskets	See page. 241

Accessories supplied: Two 400x 400 mm base baskets, 1 supplement for plates and a small basket for cutlery.

# Glasswashers

CO-402 COLD

230 V  
1 N

## General characteristics

- Electronic control and display of temperature, functions and errors.
- Control with help system for technical service.
- Model for 400 x 400 mm baskets. 90s - 120s - 180s wash cycles and maximum production of 40 baskets/hour.
- Useful internal height of 270 mm.
- Tank with volume of 15 litres, with 2 kW heating element.
- Boiler with volume of 4 litres, with 2.8 kW heating element.
- Thermal stop system which guarantees a rinse temperature of 85°C. Standard factory setting disabled.

Basket  
400 X 400 mm

	MODEL	CODE 50 HZ.*	€
<b>CHARACTERISTICS</b>			
<b>Basic model</b>	<b>CO-402 COLD</b>	<b>19073542</b>	-
Manual push button for final cold rinse	COLD	COLD	
Voltage	230 V / 1N		
Power (kW)	3,06		
Dimensions (mm)	470x525x720		
<b>Versions</b>			
Drainage pump	B	CO-402 COLD B	19075256
Peristaltic detergent doser	DD	CO-402 COLD DD	19075257
Drainage pump and peristaltic detergent doser	B - DD	CO-402 COLD B DD	19075254
Softener and peristaltic detergent doser	SOFT - DD	CO-402 SOFT DD	19073547

\* Consult other possible factory versions.

<b>ACCESORIES</b>	
Stands	See page. 182
Conversion kits	See page. 182
Water softeners	See page. 204
Baskets	See page. 241

Accessories supplied: Two 400x 400 mm base baskets, 1 supplement for plates and a small basket for cutlery.

## CONCEPT

## Glasswashers

CO-400

230 V  
1 N

- Highly resistant control buttons.
- 400 x 400 mm baskets.
- 120s fixed wash cycle and maximum production of 30 baskets/hour.
- Useful internal height of 270 mm.
- Tank with volume of 15 litres, with 2 kW heating element.
- Boiler with volume of 4 litres, with 2.8 kW heating element.

Basket  
400 x 400 mm

		MODEL	CODE 50 HZ.*	€
<b>CHARACTERISTICS</b>				
<b>Basic model</b>		<b>CO-400</b>	<b>19073541</b>	-
Voltage		230 V / 1N		
Power	(kW)	3,06		
Dimensions	(mm)	470x525x720		
<b>VERSIONS</b>				
Drainage pump	B	CO-400 B	19081172	-
Peristaltic detergent doser	DD	CO-400 DD	19081173	-
<b>Cold model</b>		<b>CO-400 COLD</b>	<b>19073546</b>	
Manual push button for final cold rinse	COLD	COLD		
<b>VERSIONS</b>				
Drainage pump	B	CO-400 COLD B	19075251	-
Peristaltic detergent doser	DD	CO-400 COLD DD	19075252	-
Drainage pump and peristaltic detergent doser	B - DD	CO-400 COLD B DD	19075253	-

\* Consult other possible factory versions.

<b>ACCESORIES</b>	
Stands	See page. 182
Conversion kits	See page. 182
Water softeners	See page. 204
Baskets	See page. 241

Accessories supplied: Two 400x 400 mm base baskets, 1 supplement for plates and a small basket for cutlery.

## CONCEPT

## Glasswashers

CO-350

230 V  
1 N**General characteristics**

- Highly resistant control buttons.
- 350 x 350 mm baskets.
- 120s fixed wash cycle and maximum production of 30 baskets/hour.
- Useful internal height of 220 mm.
- Tank with volume of 11 litres, with 2 kW heating element.
- Boiler with volume of 4 litres, with 2.4 kW heating element.

Basket  
350 x 350 mm

		MODEL	CODE 50 HZ.*	€
<b>CHARACTERISTICS</b>				
<b>Basic model</b>		<b>CO-350</b>	<b>19073540</b>	-
Voltage		230 V / 1N		
Power	(kW)	2,66		
Dimensions	(mm)	430x480x660		
<b>VERSIONS</b>				
Drainage pump	B	CO-350 B	19075244	-
Peristaltic detergent doser	DD	CO-350 DD	19075245	-
Drainage pump and peristaltic detergent doser	B - DD	CO-350 B DD	19075246	-
<b>CHARACTERISTICS</b>				
<b>Cold model</b>		<b>CO-350 COLD</b>	<b>19073545</b>	-
Manual push button for final cold rinse	COLD	COLD		
<b>VERSIONS</b>				
Drainage pump	B	CO-350 COLD B	19075247	-
Peristaltic detergent doser	DD	CO-350 COLD DD	19075248	-
Drainage pump and peristaltic detergent doser	B - DD	CO-350 COLD B DD	19075249	-

\* Consult other possible factory versions.

Accessories supplied: Two 350x 350 mm base baskets, 1 supplement for plates and a small basket for cutlery.

TECHNICAL DATA	CONCEPT +		CONCEPT	
	COP-404	CO-402	CO-400	CO-350
<b>WASH CYCLES</b>				
Cycle Time [s]	90/120/180	90/120/180	120	120
<b>THEORETICAL CAPACITY *1</b>				
Baskets [baskets/h]	40	40	30	30
Glasses [glasses/h]	1000	1000	750	480
<b>WATER CONSUMPTION</b>				
Tank capacity [l]	15	15	15	11
Boiler capacity	4	4	4	4
Rinse water consumption ** [l]	2.2	2.2	2.2	2.2
<b>TEMPERATURES</b>				
Tank temperature [°C]	60	60	60	60
Rinse water temperature [°C]	85	85	85	85
<b>DIMENSIONS</b>				
Width [mm]	470	470	470	430
Depth [mm]	525	525	525	480
With the door open [mm]	846	846	846	660
Height **3 [mm]	720	720	720	660
Useful height [mm]	270	270	270	220
Basket size [mm]	400x400	400x400	400x400	350x350
<b>ELECTRICAL SPECIFICATIONS</b>				
Total connected load (Alt) [kW]	3.06	3.06	3.06	2.66
Fuse protection [A]	16	16	16	16
Wash pump (P1) [kW]	0.26	0.26	0.26	0.26
Tank power [kW]	2	2	2	2
Rinse pump [kW]	0.13	-	-	-
Boiler power [kW]	2.8	2.8	2.8	2.4
Connection (factory default)	230V/50Hz/1N~	230V/50Hz/1N~	230V/50Hz/1N~	230V/50Hz/1N~
<b>OTHER INFORMATION</b>				
Min. inlet temperature [°C]	50	50	50	50
Max. inlet temperature [°C]	60	60	60	60
Required mains pressure [bar/kPA]	1-4/100-400	2-4/200-400	2-4/200-400	2-4/200-400
Max. drain height (only models B) [mm]	500(B)	500(B)	500(B)	500(B)
Noise level (dBA) [dBA]	<70	<70	<70	<70
Moisture protection	IPX4	IPX4	IPX4	IPX4
Net/gross weight [kg]	35/42	35/42	35/42	30/37
Wash arms	Stainless steel	Stainless steel	Stainless steel	Composite material
<b>ACCESSORIES</b>				
Glasses basket [un]	2	2	2	2
Small cutlery basket [un]	1	1	1	1
Supplement for dishes [un]	1	1	1	1

\*1 Customer circumstances (inlet water temperature/electrical connection) may reduce the values indicated here.

\*\*2 Non-binding information. The actual rinse water requirements may vary depending on site conditions.

\*\*3 The adjustable feet allow the vertical dimensions to be raised as required up to 25 mm.

## Accessories for glasswashers

WAGB-S



WAGB-XL + CO-400





### Stand for glasswashers

- Made of stainless steel.
- It can be used to store the containers of detergent and rinse aid.
- Allows you to install the glasswashers without drain pump; the water drains by gravity.

MODEL	CODE	VALID FOR MODELS	CHARACTERISTICS	DIMENSIONS (mm)	
WAGB-XL	19105218	CO-404 / CO-402 COLD / CO-400	Capacity for 2 baskets 400x400	470x465x505	-
WAGB-S	19105217	CO-404 / CO-402 COLD / CO-400 / CO-350		465x433x90	-

### Kit to transform the basic versions (except for soft versions)

MODEL	CODE	VALID FOR	DESCRIPTION	POWER (W)	€
DD 	19059327	Hood dishwashers Front-opening dishwashers Glasswashers	Peristáltic detergent doser	-	-
B-AF 	19013376	Front-opening dishwashers Glasswashers	Kit drain pump - 50/60 hz.	35	-



# Front loading dishwashers

Advance.....	185
Concept + .....	186
Concept .....	187
Accesorios .....	192

**Water connection:**  
It is advisable to introduce sanitary water in the dishwashers, with a temperature of 50 - 60 °C.

**Water pressure:**  
Minimum: 2 bar = 2 kg/cm<sup>2</sup>  
Maximum: 4 bar = 4 kg/cm<sup>2</sup>

**Water softener:**  
All glass / dishwashers should be connected to a treated water supply when the local supply is over 10 HF / 6 HD.

Any issues derived from a bad installation that don't meet with the indicated conditions will not be considered as a warranty.



Reliability and comfort  
combined with  
high efficiency.



Access the website



Sales brochure

# Front loading

AD-505

**EFFI  
RINSE**

## General characteristics

- Electronic and digital control.
- Digital display with information on programs, times and temperatures.
- Electronic programmer with help system for technical service.
- Rinse pump that guarantees a perfect hygienic result with a complete rinse at 80–85 °C (EFFIRINSE) in accordance with the safety and hygiene specifications of standard DIN10512.
- 60s, 90s, 120s and 'Glass' wash cycles.
- Theoretical maximum production of 60 baskets/hour.
- Self-cleaning programme: self-cleaning and automatic emptying.
- Tank with volume of 14 litres, with 1 kW heating element.
- Single-phase Multipower installation, with heating in the boiler which can be selected at time of installation, 1,9 / 2,8 / 5,6 kW.
- Multi-voltage: Allows the machine to be connected to a single-phase or three-phase voltage network (230 1N~/230 3~/400V 3N~).
- Simultaneous tank and boiler heating.
- Boiler with 5.6 kW heating element.
- Water consumption per 2.4 litre cycle.
- Stainless steel filter trays in the tank.
- IPX5 anti-humidity protection.

	MODEL	CODE 50 HZ.*	€
<b>CHARACTERISTICS</b>			
STOCK <b>Basic model</b>	<b>AD-505</b>	<b>19073539</b>	-
Rinse pump			
Drainage pump	B	B	
Peristaltic detergent doser	DD	DD	
Voltage	MULTIVOLTAGE		
Power	(KW)	MULTIPOWER	
Dimensions	(mm)	600x602x842 (1)	
<b>Versions</b>			
Softener	SOFT	AD-505 SOFT	19076139

\* Consult other possible factory versions.  
(1) SOFT Models: 600x632x842

ACCESSORIES	
Stands	See page 192
Conversion kits	See page 192
Water softeners	See page 204
Osmosis	See page 204
Baskets	See page 241

Accessories supplied: One CT-10 base basket, 1 CP-16/18 basket for plates and two cutlery holders.

# Front loading

COP-504

**EFFI  
RINSE**

## General characteristics

- Electronic control and display of temperature, functions and errors.
- Control with help system for technical service.
- Thermostop system with rinse pump that guarantees a perfect hygienic result with a complete rinse at 80–85 °C (EFFIRINSE) in accordance with the safety and hygiene specifications of standard DIN10512.
- Air Brake check valve system type AA according to EN 1717/WRAS.
- 90s, 120s y 180s wash cycles.
- Theoretical maximum production of 40 baskets/hour.
- Tank with volume of 20 litres, with 2.8 kW heating element.
- Boiler with 5.6 kW heating element.
- Single-phase Multipower installation, with heating in the boiler which can be selected at time of installation, either 2,8 / 3,7 / 5,6 kW.
- Multi-voltage: Allows the machine to be connected to a single-phase or three-phase voltage network. (230 1N~/230 3~/400V 3N~).
- Double system of filter trays in the tank.
- IPX4 anti-humidity protection.

	MODEL	CODE 50 HZ.*	€
<b>CHARACTERISTICS</b>			
STOCK <b>Basic model</b>	<b>COP-504</b>	<b>19073538</b>	-
Rinse pump			
Voltage	MULTIVOLTAGE		
Power	(kW)	MULTIPOWER	
Dimensions	(mm)	600x602x842	
<b>VERSIONS</b>			
Drainage pump	B	COP-504 B	19076134
Peristaltic detergent doser	DD	COP-504 DD	19076135
STOCK Drainage pump and peristaltic detergent doser	B DD	COP-504 B DD	19076136

\* Consult other possible factory versions.

ACCESSORIES	
Stands	See page 192
Conversion kits	See page 192
Water softeners	See page 204
Osmosis	See page 204
Baskets	See page 241

Accessories supplied: One CT-10 base basket, 1 CP-16/18 basket for plates and two cutlery holders.

## CONCEPT

## Front loading

CO-502



## General characteristics

- Electronic control and display of temperature, functions and errors.
- Control with help system for technical service.
- 90s, 120s and 180s wash cycles.
- Theoretical maximum production of 40 baskets/hour.
- Tank with volume of 20 litres, with 2.8 kW heating element.
- Single-phase Multipower installation, with heating in the boiler which can be selected at time of installation, either 2.8 / 3.7 / 5.6 kW.
- Multi-voltage: Allows the machine to be connected to a single-phase or three-phase voltage network. (230 1N~/230 3~/400V 3N~).
- Tray-filter in the wash tank.
- IPX4 anti-humidity protection.
- Thermal stop system which guarantees a rinse temperature of 85°C. Standard factory setting disabled.

	MODEL	CODE 50 HZ.*	€
<b>CHARACTERISTICS</b>			
© STOCK <b>Basic model</b>	<b>CO-502</b>	<b>19073537</b>	-
Voltage	MULTIVOLTAGE		
Power	(kW)	MULTIPOWER	
Dimensions	(mm)	600x602x842	
<b>VERSIONS</b>			
Drainage pump	B	CO-502 B	19076115 -
Peristaltic detergent doser	DD	CO-502 DD	19076116 -
© STOCK Drainage pump and peristaltic detergent doser	B - DD	CO-502 B DD	19076117 -

\* Consult other possible factory versions.

ACCESSORIES	
Stands	see page 192
Conversion kits	see page 192
Water softeners	see page 204
Baskets	see page 241

Accessories supplied: One CT-10 base basket, 1 CP-16/18 basket for plates and two cutlery holders.

## CONCEPT

## Front loading

CO-501



- Highly resistant control buttons.
- 90s, 120s and 180s wash cycles.
- Theoretical maximum production of 40 baskets/hour.
- Tank with volume of 20 litres, with 2.8 kW heating element.
- Single-phase Multipower installation, with heating in the boiler which can be selected at time of installation, either 2.8 / 3.7 / 5.6 kW.
- Multi-voltage: Allows the machine to be connected to a single-phase or three-phase voltage network. (230 1N~/230 3~/400V 3N~).
- Tray-filter in the wash tank.
- IPX4 anti-humidity protection.
- Thermal stop system which guarantees a rinse temperature of 85°C. Standard factory setting disabled.

	MODEL	CODE 50 HZ.*	€
<b>CHARACTERISTICS</b>			
© STOCK <b>Basic model</b>	<b>CO-501</b>	<b>19073534</b>	-
Voltage	MULTIVOLTAGE		
Power	(kW)	MULTIPOWER	
Dimensions	(mm)	600x602x842	
<b>VERSIONS</b>			
Drainage pump	B	CO-501 B	19076106 -
Peristaltic detergent doser	DD	CO-501 DD	19076107 -
© STOCK Drainage pump and peristaltic detergent doser	B - DD	CO-501 B DD	19076108 -

\* Consult other possible factory versions.

ACCESSORIES	
Stands	see page 192
Conversion kits	see page 192
Water softeners	see page 204
Baskets	see page 241

Accessories supplied: One CT-10 base basket, 1 CP-16/18 basket for plates and two cutlery holders.

## CONCEPT

## Front loading

CO-500

230 V  
1 N

## General characteristics

- Highly resistant control buttons.
- 120s wash cycle.
- Theoretical maximum production of 30 baskets/hour.
- Tank with volume of 20 litres, with 2.8 kW heating element.
- Water consumption of 2.4 liter per cycle.
- Tray-filter in the wash tank.
- IPX4 anti-humidity protection.
- Thermal stop system which guarantees a rinse temperature of 85°C. Standard factory setting disabled.

		MODEL	CODE 50 HZ.*	€
<b>CHARACTERISTICS</b>				
© STOCK	<b>Basic model</b>	<b>CO-500</b>	<b>19073532</b>	-
	Voltage	230 V / 1N		
	Power (kW)	MULTIPOWER		
	Dimensions (mm)	600x602x842		
<b>VERSIONS</b>				
	Drainage pump	B	CO-500 B	19075467
	Peristaltic detergent doser	DD	CO-500 DD	19075468
© STOCK	Drainage pump and peristaltic detergent doser	B - DD	CO-500 B DD	19075469

\* Consult other possible factory versions.

<b>ACCESORIES</b>	
Stands	see page 192
Conversion kits	see page 192
Water softeners	see page 204
Baskets	see page 241

Accessories supplied: One CT-10 base basket, 1 CP-16/18 basket for plates and two cutlery holders.

		ADVANCE	CONCEPT +	CONCEPT		
<b>Technical data</b>		<b>AD-505</b>	<b>COP-504</b>	<b>CO-502</b>	<b>CO-501</b>	<b>CO-500</b>
<b>WASH CYCLES</b>						
Cycle Time	[s]	60/90/120	90/120/180	90/120/180	90/120/180	120
<b>THEORETICAL CAPACITY*1</b>						
Baskets	[racks/h]	60	40	40	40	30
Plates	[plates/h]	1080	720	720	720	540
Glasses	[glasses/h]	2160	1440	1440	1440	1080
<b>WATER CONSUMPTION</b>						
Tank capacity	[l]	14	20	20	20	20
Boiler capacity		7	7	7	7	7
Rinse water consumption per cycle *2	[l]	2.4	2.4	2.4	2.4	2.4
<b>TEMPERATURES</b>						
Tank temperature	[°C]	60 (55-71)	60	60	60	60
Rinse water temperature	[°C]	82 (65-85)/PG 65	85	85	85	85
<b>DIMENSIONS</b>						
Width	[mm]	600	600	600	600	600
Depth	[mm]	602	602	602	602	602
With the door open	[mm]	1020	1020	1020	1020	1020
With water softener		1060	1060	1060	1060	1060
Height *3	[mm]	842	842	842	842	842
Useful height	[mm]	360	360	360	360	360
Basket size	[mm]	500X500	500X500	500X500	500X500	500X500
<b>ELECTRICAL SPECIFICATIONS</b>						
Total connected load (Alt/Sim)	[kW]	See table	See table	See table	See table	See table
Fuse protection	[A]	See table	See table	See table	See table	See table
Wash pump (P1)	[kW]	0.59	0.59	0.59	0.59	0.59
Tank power	[kW]	1	2,8	2,8	2,8	2,8
Rinse pump	[kW]	0.25	0.25	-	-	-
Boiler power	[kW]	See table	See table	See table	See table	2,8
Connection (factory default)		230V/50Hz/1N~	230V/50Hz/1N~	230V/50Hz/1N~	230V/50Hz/1N~	230V/50Hz/1N~
<b>OTHER INFORMATION</b>						
Min. inlet temperature	[°C]	15	15	15	15	50
Max. inlet temperature	[°C]	60	60	60	60	60
Required mains pressure	[bar/kPA]	1.0-4.0/100-400	1.0-4.0/100-400	2.0-4.0/200-400	2.0-4.0/200-400	2.0-4.0/200-400
Max. drain height (only B models)	[mm]	500	500(B)	500(B)	500(B)	500(B)
Noise level (dBA)	[dBA]	<65	<65	<65	<65	<65
Moisture protection		IPX5	IPX4	IPX4	IPX4	IPX4
Net/gross weight	[kg]	60/77	60/77	58/75	58/75	58/75
Rinsing arms		sst	sst	sst	sst	sst
<b>ACCESSORIES</b>						
Glasses basket	[un]	1	1	1	1	1
Small cutlery basket	[un]	2	2	2	2	1
Baskets for plates	[un]	1	1	1	1	1

\*1 Customer circumstances (inlet water temperature/electrical connection) may reduce the values indicated here.

\*2 Non-binding information. The actual rinse water requirements may vary depending on site conditions.

\*3 The adjustable feet allow the vertical dimensions to be raised as required up to 25 mm.



AD-505	380 V - 415 V / 3N~	16 A	15 A	7.2 kW	SIM	1 kW	5,6 kW	0.6 kW	
	220 V - 240 V / 1N~	13 A	10.7 A	2.5 kW	ALT	1 kW	1.9 kW	0.6 kW	
	220 V - 240 V / 1N~	FD	16 A	15 A	3.5 kW	SIM	1 kW	1.9 kW	0.6 kW
	220 V - 240 V / 1N~		20 A	19.1 A	4.4 kW	SIM	1 kW	2.8 kW	0.6 kW
	220-240V 3~		25 A	21 A	7.2 kW	SIM	1 kW	5.6 kW	0.6 kW
COP-504	380 V - 415 V / 3N~	16 A	14.7 A	6.2 kW	ALT	2.8 kW	5.6 kW	0.6 kW	
CO-502	220 V - 240 V / 1N~	FD	16 A	14.7 A	ALT	2.8 kW	2.8 kW	0.6 kW	
CO-501	220 V - 240 V / 1N~		20 A	18.8 A	ALT	2.8 kW	3.7 kW	0.6 kW	
	220-240V 3~		20 A	16.6 A	ALT	2.8 kW	5.6 kW	0.6 kW	
CO-500	220 V - 240 V / 1N~	FD	16 A	14.7 A	ALT	2.8 kW	2.8 kW	0.6 kW	



## Accessories for front loading

### WAUB-XL + CO-500





- Made of stainless steel.
- Valid for the front loading dishwashers of the E-VO Generation.
- Space for baskets 500 x 500 mm.

- Capacity for 2 baskets height 110 mm (CT-10, CP-16/18, CV-16/105...).
- It can be used to store the containers of detergent and rinse aid.

- Allows you to install the dishwasher without drain pump; the water drains by gravity.

MODEL	CODE	CHARACTERISTICS	DIMENSIONS (mm)	€
WAUB-XL	19105219	Capacity for 3 baskets 500x500	580x565x400	-

### Kit to transform the basic versions (except for soft versions)

MODEL	CODE	VALID FOR	DESCRIPTION	POWER (W)	€
DD 	19059327	Hood dishwashers Front-opening dishwashers Glasswashers	Peristáltic detergent doser	-	-
B-AF 	19013376	Front-opening dishwashers Glasswashers	Kit drain pump - 50/60 hz.	35	-

### Kit trays-filter for wash tank

MODEL	CODE	DESCRIPTION	€
K-BF-500 	19087264	Kit of 2 tray filters for wash tank in CO models	-

### Transformations to other voltages

OPTION	DESCRIPTION	€
400- 440V 3~ (FL)	400- 440V 3~ connection for ships in COP-504, CO-502 and CO-501	-



Simplicity and agility  
for large quantities  
and intensive use.



Access the website



Sales brochure

## Hood-type dishwashers

Advance.....	195
Concept + .....	197
Concept .....	198
Accesorios .....	201

**Water connection:**

It is advisable to introduce sanitary water in the dishwashers, with a temperature of 50 - 60 °C.

**Water pressure:**

Minimum: 2 bar = 2 kg/cm<sup>2</sup>  
Maximum: 4 bar = 4 kg/cm<sup>2</sup>

**Water softener:**

All glass / dishwashers should be connected to a treated water supply when the local supply is over 10 HF / 6 HD.

Any issues derived from a bad installation that don't meet with the indicated conditions will not be considered as a warranty.

## Hood-type

AD-125

EFFI  
RINSE

## General characteristics

- Electronic and digital control.
- Digital display with information on programs, times and temperatures.
- Electronic programmer with help system for technical service.
- Thermostop system with rinse pump that guarantees a perfect hygienic result with a complete rinse at 80-85 °C (EFFIRINSE) according to the safety and hygiene specifications of DIN10512.
- 55s, 75s, 120s, 480s and 'Glass' wash cycles.
- Theoretical maximum production of 65 baskets/hour (1170 plates/h).
- Self-cleaning programme: self-cleaning and automatic emptying.
- Double-walled Hood with special compressed insulating material.
- Tank with volume of 28 litres, with 2.1 kW heating element.
- Boiler with volume of 9 litres, with 9 kW heating element.
- Simultaneous tank and boiler heating.
- Maximum Total power: 11.85 kW (simultaneous).
- Drainage pump - power 70 W - tank emptying program.
- Peristaltic rinse aid doser incorporated.
- Peristaltic rinse aid doser incorporated.
- Air Brake check valve system type AA according to EN 1717/WRAS.
- IPX5 anti-humidity protection.

	MODEL	CODE 50 HZ.*	€
<b>CHARACTERISTICS</b>			
<b>Basic model</b>	<b>AD-125</b>	<b>19073921</b>	<b>-</b>
Rinse pump			
Drainage pump	B	B	
Peristaltic detergent doser	DD	DD	
Voltage	MULTIVOLTAGE		
Power	(kW)	MULTIPOWER	
Dimensions	(mm)	630 x 750 x 1.465	
<b>VERSIONS</b>			
Softener	SOFT	AD-125 SOFT	19075295 -
<b>CHARACTERISTICS</b>			
<b>Model with recovery system</b>	<b>AD-125 HRS</b>	<b>19075296</b>	<b>-</b>
Heat recovery system	HRS	HRS	
Dimensions	(mm)	630 x 750 x 1.990	
<b>VERSIONS</b>			
Softener	SOFT	AD-125 SOFT HRS	19074195 -

\* Consult other possible factory versions.

<b>ACCESORIES</b>	
Entry-exit tables	see page 202
Conversion kits	see page 201
Water softeners	see page 204
Osmosis	see page 204
Baskets	see page 241

Accessories supplied: One CT-10 base basket, 1 CP-16/18 basket for plates and two cutlery holders.

## Hood-type

AD-125 ECO

ECO  
TECHNOLOGY  
FOR A  
SUSTAINABLE  
FUTURE

## General characteristics

- Electronic and digital control.
- Digital display with information on programs, times and temperatures.
- Electronic programmer with help system for technical service.
- Rinse pump which guarantees a perfect hygiene result with complete linear rinse cycle at 85°C. (EFFIRINSE) in accordance with the safety and hygiene specifications of the DIN10512 standard.
- 55s, 75s, 120s and 480s wash cycles.
- Double-walled Hood with special compressed insulating material.
- Tank with volume of 28 litres, with 2.1 kW heating element.
- The ECO version hood type dishwashers are prepared to be connected to an external hot water generator, with gas heating, model GWB-20.
- The generator replaces the electric rinse boiler in the dishwasher, bringing a significant saving in electricity consumption.

**Note:** The generator is already included in the price of the dishwasher. When ordering, the GWB-20 generator code must be added to the machine code.

	MODEL	CODE 50 HZ.*	€
<b>CHARACTERISTICS</b>			
<b>Basic model</b>	<b>AD-125 ECO</b>	<b>19075300</b>	<b>-</b>
Rinse pump			
Drainage pump	B	B	
Peristaltic detergent doser	DD	DD	
Voltage	MULTIVOLTAGE		
Power	(kW)	2,70	
Dimensions	(mm)	630 x 750 x 1.465	

Accessories supplied: One CT-10 base basket, 1 CP-16/18 basket for plates and two cutlery holders.

\* Consult other possible factory versions.

## Gas hot water generator GWB-20

Forced draught burner and double safety valve. Electronic control of temperature and water levels. Automatic limescale removal. Automatic tank emptying.

	MODEL	CODE 50 HZ.*	€
Power	(kW)	20	
Dimensions	(mm)	432x548x770	
Butane/propane gas	LPG	GWB-20 LPG	19010831 -
Natural gas	GN	GWB-20 GN	19038551 -

\* Consult other possible factory versions.

## Hood-type

COP-144

EFFI  
RINSE

## General characteristics

- Electronic control and display of temperature, functions and errors.
- Control with help system for technical service.
- Thermostop system with rinse pump that guarantees a perfect hygienic result with a complete rinse at 80–85 °C (EFFIRINSE) in accordance with the safety and hygiene specifications of standard DIN10512.
- Air Brake check valve system type AA according to EN 1717/WRAS.
- 55s, 75s, 120s and 600s wash cycles.
- Theoretical maximum production of 65 baskets/hour (1170 plates/h).
- Tank with volume of 33 litres, with 4.5 kW heating element.
- Boiler with volume of 9 litres, with 9 kW heating element.
- Alternating or simultaneous tank and boiler heating.
- Maximum Total power: 9.75 kW (alternating) or 14.75 kW (simultaneous).
- IPX4 anti-humidity protection.

	MODEL	CODE 50 HZ.*	€
<b>CHARACTERISTICS</b>			
© STOCK <b>Basic model</b>	<b>COP-144</b>	<b>19073920</b>	-
Rinse pump			
Voltage	MULTIVOLTAGE		
Power	(kW)	9,75 / 14,25	
Dimensions	(mm)	630 x 750 x 1.465	
<b>VERSIONS</b>			
Drainage pump	B	COP-144 B	19075288 -
Peristaltic detergent doser	DD	COP-144 DD	19075289 -
© STOCK Drainage pump and detergent doser	B - DD	COP-144 B DD	19075290 -
<b>CHARACTERISTICS</b>			
<b>Model with recovery system</b>	<b>COP-144 HRS</b>	<b>19075044</b>	-
Heat recovery system	HRS	HRS	
Dimensions	(mm)	630 x 750 x 1.990	
<b>Versions</b>			
Drainage pump and detergent doser	B - DD	COP-144 HRS B DD	19075291 -

\* Consult other possible factory versions.

ACCESSORIES	
Entry-exit tables	see page 202
Conversion kits	see page 201
Water softeners	see page 204
Osmosis	see page 204
Baskets	see page 241

Accessories supplied: One CT-10 base basket, 1 CP-16/18 basket for plates and two cutlery holders.

## Hood-type

CO-142



## General characteristics

- Electronic control and display of temperature, functions and errors.
- 55s, 75s, 120s and 600s wash cycles.
- Theoretical maximum production of 65 baskets/hour (1170 plates/h).
- Tank with volume of 33 litres, with 4.5 kW heating element.
- Boiler with volume of 9 litres, with 9 kW heating element.
- Alternating or simultaneous tank and boiler heating.
- Thermal stop system which guarantees a rinse temperature of 85°C. Standard factory setting disabled.
- Maximum Total power: 9.75 kW (alternating) or 14.75 kW (simultaneous).
- IPX4 anti-humidity protection.

	MODEL	CODE 50 HZ.*	€
<b>CHARACTERISTICS</b>			
© STOCK <b>Basic model</b>	<b>CO-142</b>	<b>19073919</b>	-
Voltage	MULTIVOLTAGE		
Power	(kW)	9,75 / 14,25	
Dimensions	(mm)	630 x 750 x 1.465	
<b>VERSIONS</b>			
Drainage pump	B	CO-142 B	19075277 -
Peristaltic detergent doser	DD	CO-142 DD	19075278 -
© STOCK Drainage pump and peristaltic detergent doser	B - DD	CO-142 B DD	19075279 -
<b>CHARACTERISTICS</b>			
© STOCK <b>Model with recovery system</b>	<b>CO-142 HRS</b>	<b>19075041</b>	-
Heat recovery system	HRS	HRS	
Dimensions	(mm)	630 x 750 x 1.990	
<b>VERSIONS</b>			
Drainage pump and peristaltic detergent doser	B - DD	CO-142 HRS B DD	19075282 -

\* Consult other possible factory versions.

ACCESSORIES	
Entry-exit tables	see page. 202
Conversion kits	see page. 201
Water softeners	see page. 204
Baskets	see page. 241

Accessories supplied: One CT-10 base basket, 1 CP-16/18 basket for plates and two cutlery holders.



## Hood-type

CO-110



## General characteristics

- Highly resistant control buttons.
- 90s, 120s, 180s and 600s wash cycles.
- Theoretical maximum production of 40 baskets/hour.
- Tank with volume of 33 litres, with 4.5 kW heating element.
- Boiler with volume of 9 litres, with 6 kW heating element.
- Alternating or simultaneous tank and boiler heating.
- Thermal stop system which guarantees a rinse temperature of 85°C. Standard factory setting disabled.
- Maximum Total power: 6.75 kW (alternating) or 11.25 kW (simultaneous).
- IPX4 anti-humidity protection.

		MODEL	CODE 50 HZ.*	€
<b>CHARACTERISTICS</b>				
© STOCK	<b>Basic model</b>	<b>CO-110</b>	<b>19073548</b>	-
	Voltage	MULTIVOLTAGE		
	Power (kW)	6,75 / 11,25		
	Dimensions (mm)	630 x 750 x 1.465		
<b>VERSIONS</b>				
	Drainage pump	B	CO-110 B	19075270
	Peristaltic detergent doser	DD	CO-110 DD	19075271
© STOCK	Drainage pump and peristaltic detergent doser	B - DD	CO-110 B DD	19075272
<b>CHARACTERISTICS</b>				
	<b>Model with recovery system</b>	<b>CO-110 HRS</b>	<b>19075016</b>	-
	Heat recovery system	HRS	HRS	
	Dimensions (mm)	630 x 750 x 1.990		
<b>VERSIONS</b>				
	Drainage pump and peristaltic detergent doser	B - DD	CO-110 HRS B DD	19075273
* Consult other possible factory versions.				
<b>ACCESSORIES</b>				
	Entry-exit tables	see page. 202		
	Conversion kits	see page. 201		
	Water softeners	see page. 204		
	Baskets	see page. 241		

Accessories supplied: One CT-10 base basket, 1 CP-16/18 basket for plates and two cutlery holders.

TECHNICAL DATA	ADVANCE		CONCEPT +	CONCEPT	
	AD-125	AD-125 ECO	COP-144	CO-142	CO-110
<b>WASH CYCLES</b>					
Cycle Time [s]	55/75/120/480	55/75/120/480	55/75/120/600	55/75/120/600	90/120/180/600
<b>THEORETICAL CAPACITY*1</b>					
Baskets [baskets/h]	65	65	65	65	40
Plates [plates/h]	1170	1170	1170	1170	720
Glasses [glasses/h]	2340	2340	2340	2340	1440
<b>WATER CONSUMPTION</b>					
Tank capacity [l]	28	28	33	33	33
Boiler capacity	10	13	10	9	9
Rinse water consumption per cycle **	2.4	2.4	2.4	2.4	2.4
<b>TEMPERATURES</b>					
Tank temperature [°C]	60 (55-71)	60 (55-71)	60	60	60
Rinse water temperature [°C]	82 (65-85)	82 (65-85)	85	85	85
<b>DIMENSIONS</b>					
Width [mm]	630 (712)	630 (712)	630 (712)	630 (712)	630 (712)
Depth [mm]	750 (830)	750 (830)	750 (830)	750 (830)	750 (830)
Height with hood closed **	1465	1465	1465	1465	1465
Height with hood open [mm]	1940	1940	1940	1940	1940
Height with HRS [mm]	1990	1990	1990	1990	1990
Operating height [mm]	820-890	820-890	820-890	820-890	820-890
Useful height [mm]	430	430	430	430	430
Basket size [mm]	500x500	500x500	500x500	500x500	500x500
<b>ELECTRICAL SPECIFICATIONS</b>					
Total power connected(Alt/Sim) [kW]	See table	See table	See table	See table	See table
Fuse protection [A]	See table	See table	See table	See table	See table
Wash pump (P1) [kW]	0.75	0.75	0.75	0.75	0.75
Tank power [kW]	2.1	2.1	4.5	4.5	4.5
Rinse pump [kW]	0.25	0.25	0.25	-	-
Boiler power [kW]	9	-	9	9	6
Connection (factory default)	400V/50Hz/3N~	400V/50Hz/3N~	400V/50Hz/3N~	400V/50Hz/3N~	400V/50Hz/3N~
<b>OTHER INFORMATION</b>					
Min. inlet temperature [°C]	15	15	15	15	15
Max. inlet temperature [°C]	60	60	60	60	60
Required mains pressure [bar/kPA]	1.0-4.0/100-400	1.0-4.0/100-400	1.0-4.0/100-400	2.0-4.0/200-400	2.0-4.0/200-400
Required mains pressure for HRS models [bar/kPA]	2.0-4.0/200-400	2.0-4.0/200-400	2.0-4.0/200-400	2.0-4.0/200-400	2.0-4.0/200-400
Max. drain height (only B models) [mm]	600	600	130/600(B)	130/600(B)	130/600(B)
Noise level (dBA) [dBA]	<65	<65	<70	<70	<70
Moisture protection	IPX5	IPX5	IPX4	IPX4	IPX4
Net/gross weight [kg]	111/129	109/127	97/115	95/113	95/113
Net/gross weight with HRS [kg]	127/147	125/145	113/133	111/131	111/131
Rinsing arms	Stainless steel	Stainless steel	Stainless steel	Stainless steel	Stainless steel
<b>ACCESSORIES</b>					
Glasses basket [un]	1	1	1	1	1
Small cutlery basket [un]	2	2	2	2	2
Baskets for plates [un]	1	1	1	1	1

\*1 Customer circumstances (inlet water temperature/electrical connection) may reduce the values indicated here.

\*\* Non-binding information. The actual rinse water requirements may vary depending on site conditions.

\*\*3 The adjustable feet allow the vertical dimensions to be raised as required up to 75 mm.

	VOLTAGE	FACTORY DEFAULT	FUSE PROTECTION	TOTAL AMP.	TOTAL CONNECTED LOAD	CONNECTION	TANK POWER	BOILER POWER	WASH PUMP POWER
AD-125	380 V - 415 V / 3N~	FD	20 A	18.7 A	11,85 kW	SIM	2.1 kW	9 kW	0.75 kW
	220 V - 240 V / 1N~		32 A	26.7 A	6,35 kW	SIM	1.1 kW	4.5 kW	0.75 kW
	220 V - 240 V / 1N~		40 A	34.8 A	8,15 kW	SIM	1.4 kW	6 kW	0.75 kW
	220-240V 3~		40 A	30,5 A	11,85 kW	SIM	2.1 kW	9 kW	0.75 kW
AD-125 ECO	380 V - 415 V / 3N~	FD	16 A	5.7 A	2,85 kW	-	2.1 kW	-	0.75 kW
	220 V - 240 V / 1N~		16 A	11.8 A	2,85 kW	-	2.1 kW	-	0.75 kW
	220-240V 3~		16 A	7.9 A	2,85 kW	-	2.1 kW	-	0.75 kW
"COP-144 CO-142"	380 V - 415 V / 3N~		20 A	15.7 A	9,75 kW	ALT	4.5 Kw	9 kW	0.75 kW
	380 V - 415 V / 3N~	FD	25 A	22.2 A	14,25 kW	SIM	4.5 Kw	9 kW	0.75 kW
	220 V - 240 V / 1N~		25 A	22.2 A	5,25 kW	ALT	2.3 Kw	4.5 kW	0.75 kW
	220 V - 240 V / 1N~		32 A	28.7 A	6,75 kW	ALT	3 Kw	6 kW	0.75 kW
	220 V - 240 V / 1N~		50 A	41.8 A	9,75 kW	ALT	4.5 Kw	9 kW	0.75 kW
	220 V - 240 V / 1N~		40 A	32 A	7,55 kW	SIM	2.3 Kw	4.5 kW	0.75 kW
	220 V - 240 V / 1N~		50 A	41.8 A	9,75 kW	SIM	3 Kw	6 kW	0.75 kW
	220-240V 3~		32 A	25.2 A	9,75 kW	ALT	4.5 Kw	9 kW	0.75 kW
	220-240V 3~		40 A	36.5 A	14,25 kW	SIM	4.5 Kw	9 kW	0.75 kW
	220-240V 3~		16 A	11.3 A	6,75 kW	ALT	4.5 Kw	6 kW	0.75 kW
CO-110	380 V - 415 V / 3N~	FD	20 A	17.8 A	11,25 kW	SIM	4.5 Kw	6 kW	0.75 kW
	220 V - 240 V / 1N~		20 A	15.7 A	3,75 kW	ALT	2.25 Kw	3 kW	0.75 kW
	220 V - 240 V / 1N~		25 A	20 A	4,75 kW	ALT	3 Kw	4 kW	0.75 kW
	220 V - 240 V / 1N~		32 A	28.7 A	6,75 kW	ALT	4.5 Kw	6 kW	0.75 kW
	220 V - 240 V / 1N~		32 A	25.7 A	6,05 kW	SIM	2.25 Kw	3 kW	0.75 kW
	220 V - 240 V / 1N~		40 A	33 A	7,75 kW	SIM	3 Kw	4 kW	0.75 kW
	220 V - 240 V / 1N~		50 A	48,3 A	11,25 kW	SIM	4.5 Kw	6 kW	0.75 kW
	220-240V 3~		20 A	17.7 A	6,75 kW	ALT	4.5 Kw	6 kW	0.75 kW
	220-240V 3~		32 A	29 A	11,25 kW	SIM	4.5 Kw	6 kW	0.75 kW

### Tables for hood-type dishwashers

- Worktop made of stainless steel with satin finish.
- Welded bowl 450 x 450 x 250 mm.
- Shower unit not included, but provided with a hole to fit it.
- Sorting hole with black rubber ring flush with the worktop for disposal of waste into a rubbish bin (not included).
- Splashback 100 x 15 mm.
- Square stainless steel legs 40 x 40 mm.
- Frame height 850 mm with height-adjustable stainless steel legs (-10 mm / + 50 mm).
- Supplied disassembled.

### Tables without bowl



### Tables without bowl and with splashback



DIMENSIONS	CODE	MODEL	€	RIGHT			€			
				DIMENSIONS	CODE	MODEL				
700x620x850	19104311	WHTC-70	-	700x740x850	19104313	WHTW-70 R	-	19104312	WHTW-70 L	-
1200x620x850	19105486	WHTC-120	-	1200x740x850	19104315	WHTW-120 R	-	19104314	WHTW-120 L	-

### Tables with bowl and splashback



DIMENSIONS	RIGHT			LEFT		
	CODE	MODEL	€	CODE	MODEL	€
700x740x850	19104319	WHTWB-70 R	-	19104318	WHTWB-70 L	-
1200x740x850	19104321	WHTWB-120 R	-	19104320	WHTWB-120 L	-

## Tables for hood type dishwashers

### Kit to transform the basic versions

MODEL	CODE	DESCRIPTION	POWER (W)	€
DD	19059327	PERISTALTIC DETERGENT DOSER		-
B-CAP	19059326	KIT DRAIN PUMP HOOD TYPE	96	-

### Transformations to other voltages

MODEL	DESCRIPTION	€
400- 440V 3~ (HT)	400- 440V 3~ connection for ships in Hood type dishwashers	-

### Tables with bowl, sorting hole and splashback



DIMENSIONS	RIGHT			LEFT		
	CODE	MODEL	€	CODE	MODEL	€
1200x740x850	19104323	WHTWBS-120 R	-	19104322	WHTWBS-120 L	-
1500x740x850	19104325	WHTWBS-150 R	-	19104324	WHTWBS-150 L	-

### Side closure



RIGHT			LEFT		
CODE	MODEL	€	CODE	MODEL	€
19104327	WHSC-R	-	19104326	WHSC-L	-

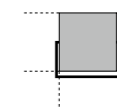

### Union element for hood dishwashers

CODE	MODEL	DIMENSIONS (mm)	€
19104316	WHTJ-14	140	-
19104317	WHTJ-62	640	-

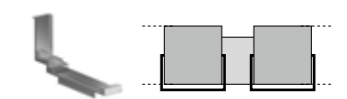

# Water treatment

## What you can achieve with treatment of water

Most of the water that comes out of the tap seems perfectly pure, however it may contain, as already mentioned, invisible contaminants. Removing these elements has a decisive influence on water quality.

Calcium and magnesium (hardness) are eliminated and the useful life of the equipment is significantly extended, reducing maintenance interventions and the use of detergents and rinse aids.

	SOFTNER	REVERSE OSMOSIS
EXCELLENT WASH		X
SAVING DETERGENTS	X	X
REDUCES GLASS AND CERAMICS WEAR		X
PROTECTS THE MACHINE	X	X
GOODBYE MANUAL DRYING		X

## Water treatment methods

Water treatment occurs mainly in two ways.

### SOFTNER

The result obtained by using the water softener is to eliminate the calcium Ca<sup>2+</sup> and magnesium Mg<sup>2+</sup> ions, responsible for the hardness of the water. This effectively prevents the formation of encrustations which over time reduce the performance of the machines and cause malfunctions.

### REVERSE OSMOSIS

Thanks to the very high degree of filtration that characterizes reverse osmosis machines, it is possible to obtain water with high quality characteristics. Water, passing through one or more membranes, is deprived not only of the elements that determine its hardness, but also of all substances contaminants, responsible, for example, for unwanted odors and flavors.

For excellent results and long maintenance intervals, the two technologies can be combined.



## Manual water softeners

For hardness bigger than 5 HF / 3 HD.

Manual maintenance required.

CODE	DESCRIPTION	CAPACITY OF REGENERATION (*)	DIMENSIONS (mm)	€
19004690	DESCALING KIT 12 L.	1.050 litres between 2 regenerations	Ø 185x560 mm	-
19004798	DESCALING KIT 16 L.	1.400 litres between 2 regenerations	Ø 185x740 mm	-



## Reverse osmosis

### GREAT ADVANTAGES OF REVERSE OSMOSIS:

- It reduces detergent use by up to 60% and rinse aid by 70-100%.
- It polishes plates, glasses and cutlery, obtaining a mark-free washing result since it does not require drying after the wash.
- It extends the life of glassware and dishes since it reduces corrosion.
- It protects the machinery, extending its life.



### Inlet water conditions:

- Type of inlet water: drinking water.
- Inlet water temperature: 5 °C - 35 °C.
- Minimum flow: 400 l/h.
- Supply pressure: 1.5-6 bar.
- Maximum conductivity of inlet water: 1200 µS / cm.
- Maximum inlet water hardness: up to 35°f with pH below 8.5 and up to 27°f with pH above 8.5.
- As of 10°dH 15°dH or 27°f, we recommend installing a water softening system prior to osmosis to prevent blockage of the membrane.
- High-flow reverse osmosis system.
- Vertical or horizontal installation.
- Flow: 120 l/h at 15°C.
- Recovery rate from 25% to 60%.
- Typical rejection rate: 95 %.
- Electrical connection 230V ~ 50/60Hz.
- Prefilter that reduces and eliminates water turbidity, chlorine, tastes and smells. Its nominal filtration rate is 5 microns.
- Easy to install.
- Prefilter change alarm.
- Water leak alarm.
- Low-pressure alarm at system entrance.
- Manual bypass valve.

**ONLY VALID FOR: AD-505, AD-125, COP-404, COP-504 y COP-144**

MODEL	CODE	FLOW 15°C (L/H)	NUMBER OF MEMBRANES	VOLTAGE (V)	FREQUENCY (HZ)	POWER (KW)	DIMENSIONS (mm)	€
REVO-120	19076763	120	2	230	50 / 60	0,33	145 x 560 x 455	-

MODEL	CODE	DESCRIPTION	€
PREF-PACK6	19076764	Pack of 6 units of rapid-connection cartridges with extruded carbon block filter	-



Robust and powerful  
for high degrees  
of cleanliness.



Access the website

# Utensilwashers

Utensilwashers LP Series.....**208**  
Utensilwashers LP-ECO Series...**208**  
Accessories .....**207**

**Water connection:**

It is advisable to introduce sanitary water in the dishwashers, with a temperature of 50 - 60 °C.

**Water pressure:**

Minimum: 2 bar = 2 kg/cm<sup>2</sup>  
Maximum: 4 bar = 4 kg/cm<sup>2</sup>

**Water softener:**

All glass / dishwashers should be connected to a treated water supply when the local supply is over 10 HF / 6 HD.

Any issues derived from a bad installation that don't meet with the indicated conditions will not be considered as a warranty.



# Utensilwashers



## General characteristics

### LP SERIES

- LP Series for the cleaning of utensils and kitchen recipients.
- Made with double skinned of stainless steel 18/10 (AISI 304).
- Stamped tank. Double stainless steel filter.
- Electronic control panel.
- Rotating wash and rinse arms.
- Wash temperature 55°C and rinse 80°C.
- Wash cycles: 2' - 4' - 6'.
- Continuous wash cycle up to 12'.
- Maximum theoretical productivity: 30 racks/hour.
- Thermostop system.
- Built-in peristaltic rinse dispenser and detergent dispenser (DD)
- Electric connection: 380 V - 415 V / 3N~ 50 Hz.
- Self cleaning vertical washing pumps
- Rinsing pump that guarantees a perfect hygienic result and constant pressure control during the rinse.
- B: Drain pump included.
- HRS: Models available with energy recovery.

### LP-ECO SERIES

- Similar features to LP series models except:
- Do not include a rinsing pumps that allows to control the rinse pressure.
- Without rinse pump.
- Without self cleaning cycle. Fixed cycles duration: 2' - 4' - 8'.

LP-130 B DD



LP-70 B DD



LP-63 B DD



LP-62 B DD









LP-61 B DD



MODEL	CODE 50 HZ*	BASKET SIZE (mm)	USABLE HIGHT (mm)	TANK CAPACITY (L)	WATER CONSUMPTION (L/BASKETS)	POWER (kW)	DIMENSIONS (mm)	€
LP-SERIES								
LP-61 B DD	19076870	500x600	400	23	3	6,7	600x700x1.230	-
LP-62 B DD	19076872	560x630	650	37	3	7,5	720x780x1.730	-
LP-62 B DD HRS	19076873	560x630	650	37	3	7,5	720x780x1.960	-
LP-63 B DD	19072567	560x630	850	37	3	7,5	720x780x1.930	-
LP-63 B DD HRS	19076875	560x630	850	37	3	7,5	720x780x2.160	-
LP-70 B DD	19075071	700x700	850	68	4	10,7	850x860x1.960	-
LP-70 B DD HRS	19076876	700x700	850	68	4	10,7	850x850x2.160	-
LP-130 B DD	19074725	1.320x700	850	131	6	15,9	1.470x850x1.960	-
LP-130 B DD HRS	19076877	1.320x700	850	131	6	15,9	1.470x850x2.160	-
LP-SERIES ECO								
LP-61 DD ECO	19003005	500x600	400	23	3	6,7	600x700x1.230	-
LP-62 DD ECO	19003006	560x630	650	37	3	7,5	719x780x1.730	-

\* Consult other possible factory versions.  
Accessories supplied: One basket.

## Accessories for utensilwashers

MODEL	CODE	DESCRIPTION	
 CT-LP61B	19023165	Basket for LP-61 B	-
 CT-LP62	19010251	Basket for LP-62 and LP-63 H	-
 CT-LP70	19010252	Basket for LP-70	-
 CT-LP130	19011085	Basket for LP-130	-
 SMP	19010253	Support for pastry dispenser	-
 ARM8	19010254	Frame support for 8 trays	-
 CU150	19010255	Cutlery container (150 x 150 mm)	-

# Rack conveyor

Compact dishwashers .....211  
Modular dishwashers.....216  
Accessories.....222

**Water connection:**  
It is advisable to introduce sanitary water in the dishwashers, with a temperature of 50 - 60 °C.

**Water pressure:**  
Minimum: 2 bar = 2 kg/cm<sup>2</sup>  
Maximum: 4 bar = 4 kg/cm<sup>2</sup>

**Water softener:**  
All glass / dishwashers should be connected to a treated water supply when the local supply is over 10 HF / 6 HD.

Any issues derived from a bad installation that don't meet with the indicated conditions will not be considered as a warranty.



Robust and reliable machines, with an increased output capacity.



Access the website



Comercial video



Sales brochure

# Rack conveyor | Compact dishwashers

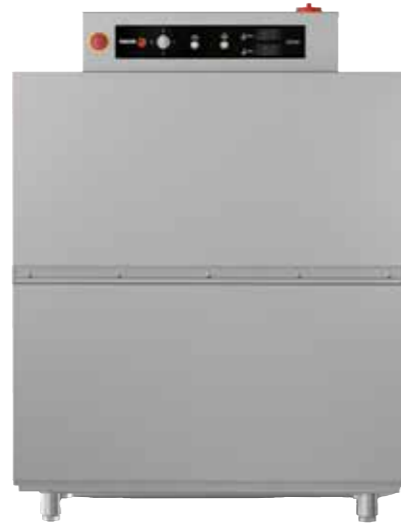

## General characteristics

- All the main parts are manufactured in AISI-304 anti-corrosion stainless steel: tanks, washing and rinsing arms, rinsing jets, doors, basket conveyance system, boiler and metal tubes.
- Upwards-opening double panel door.
- Tank tray filters made of AISI-304 stainless steel, easy to access and remove for cleaning and access to the tank.
- Safety filter for pump suction.
- Rinsing boiler with heat insulation.
- Easy access for installation. Electrovalve located on one side (no need to remove panels to connect the machine).
- Electrical panel designed for easy connection of dosers for liquid and solid detergents, rinse aid, limit switches, supplementary emergency stop button.
- Washing arms easily removable as a set, for cleaning, with a plug on each branch providing access for cleaning inside.
- Rinse jets easily dismountable and

- removable.
- System of electronic regulation of speeds by means of frequency shifter.
- Configurable electronic temperature control:
  - Wash (50 - 65 °C)
  - Rinse (70 - 85 °C)
- Guarantor of rinse at 85 °C.
- Pressure regulator for flow control.
- Emergency stop button incorporated.
- Extra anti-entrapment protection system at the entrance, mounted on the AS-260 splash guard supplement (optional).
- Open door blocking system.
- IPX4 protection system.
- System for detection of blockage of conveyor carriage and automatic reverse function.
- High-power washing system with 4 upper and 4 lower washing branches.
- 3 washing programs: deep, medium and high-capacity.

- Double effect rinse.
- Energy-saving system: reduces consumption by halting operation of the pumps, and by passing the heating of the rinse to stand-by mode (70 °C).
- Auto-timer which deactivates the conveyor motor after a pre-set period of inactivity (10 minutes).
- Energy saving system in the wash: the wash does not start up until it detects the passage of the basket.
- Rinse saving system. The rinse stops when the basket has left, saving water and energy.
- Limit switch included.

Equipment included:  
 - 2 base baskets, CT-10  
 - 2 baskets for plates CP-16/18, 1 basket for glasses CV-16/105, 1 basket for cutlery CT-10 R

MODEL	HZ (1)	CODE	ENTRANCE (*)	WATER SUPPLY	PROGRAMS (BASKETS/H)			INTERNAL ZONES (**)	WATER CONSUMPTION (L/H)	ELECTRICAL POWER (kW)	DIMENSIONS (mm)	€
					DEEP	MEDIUM	HIGH-CAPACITY					
CCO-120-L-HW	50	19048203	L	>50°	80	100	120		210	19.45	1,180 x 790 x 1,550	-
CCO-120-R-HW	50	19048204	R					LP + A				
CCO-120-L-CW	50	19045325	L	<50°	80	100	120		210	28.45	1,180 x 790 x 1,550	-
CCO-120-R-CW	50	19046527	R					LP + A				

(1): Consult other possible factory versions.  
 (\*) Entry of baskets:  
 L: Entrance from the Left of the machine.  
 R: Entrance from the Right of the machine.

(\*\*) Internal zones  
 LP: Main wash.  
 A: Double effect rinse.

# Rack conveyor | Compact dishwashers



## General characteristics

- All the main parts are manufactured in AISI-304 anti-corrosion stainless steel: tanks, washing and rinsing arms, rinsing jets, doors, basket conveyance system, boiler and metal tubes.
- Upwards-opening double panel door.
- Tank tray filters made of AISI-304 stainless steel, easy to access and remove for cleaning and access to the tank.
- Safety filter for pump suction.
- Rinsing boiler with heat insulation.
- Easy access for installation. Electrovalve located on one side (no need to remove panels to connect the machine).
- Electrical panel designed for easy connection of dosers for liquid and solid detergents, rinse aid, limit switches, supplementary emergency stop button.
- Washing arms easily removable as a set, for cleaning, with a plug on each branch providing access for cleaning inside.
- Rinse jets easily dismountable and

- removable.
- System of electronic regulation of speeds by means of frequency shifter.
- Configurable electronic temperature control:
  - Wash (50 - 65 °C)
  - Rinse (70 - 85 °C)
- Guarantor of rinse at 85 °C.
- Pressure regulator for flow control.
- Emergency stop button incorporated.
- Extra anti-entrapment protection system at the entrance, mounted on the AS-260 splash guard supplement (optional).
- Open door blocking system.
- IPX4 protection system.
- System for detection of blockage of conveyor carriage and automatic reverse function.
- High-power washing system with 4 upper and 4 lower washing branches.
- 3 washing programs: deep, medium and high-capacity.

- Double effect rinse.
- Energy-saving system: reduces consumption by halting operation of the pumps, and by passing the heating of the rinse to stand-by mode (70 °C).
- Auto-timer which deactivates the conveyor motor after a pre-set period of inactivity (10 minutes).
- Energy saving system in the wash: the wash does not start up until it detects the passage of the basket.
- Rinse saving system. The rinse stops when the basket has left, saving water and energy.
- Limit switch included.

Equipment included:  
 - 2 base baskets, CT-10  
 - 2 baskets for plates CP-16/18, 1 basket for glasses CV-16/105, 1 basket for cutlery CT-10 R

MODEL	HZ (1)	CODE	ENTRANCE (*)	WATER SUPPLY	PROGRAMS (BASKETS/H)			INTERNAL ZONES (**)	WATER CONSUMPTION (L/H)	ELECTRICAL POWER (kW)	DIMENSIONS (mm)	€
					DEEP	MEDIUM	HIGH-CAPACITY					
CCO-160-L-HW	50	19048233	L	>50°	100	130	160		240	22.45	1,180 x 790 x 1,550	-
CCO-160-R-HW	50	19048255	R					LP + A				
CCO-160-L-CW	50	19048231	L	<50°	100	130	160		240	31.45	1,180 x 790 x 1,550	-
CCO-160-R-CW	50	19048254	R					LP + A				

(1): Consult other possible factory versions.  
 (\*) Entry of baskets:  
 L: Entrance from the Left of the machine.  
 R: Entrance from the Right of the machine.

(\*\*) Internal zones  
 LP: Main wash.  
 A: Double effect rinse.

# “eco” version - gas heated

CCO-160-L-ECO + AS-260 + GWB-40



## General characteristics

- The ECO version conveyor dishwashers are fitted with an external hot water generator, gas heated, model GWB-40 (#).
- The generator replaces the electric rinse boiler in the dishwasher, bringing a significant saving in electricity consumption.
- Given the heating power of the generator, the dishwasher can be installed in facilities with a cold water connection.
- The dishwasher has a motor pump to send the water from the generator to the rinse jets.
- The dishwasher incorporates a flow regulator to ensure constant water consumption.
- The first filling of the dishwasher wash tank takes place with water from the generator, rapidly reaching the set temperature.

MODEL	HZ	CODE	ENTRANCE	WATER SUPPLY	PROGRAMS (BASKETS/H)	INTERNAL ZONES (**)	WATER CONSUMPTION (L/H)	ELECTRICAL POWER (kW)	GAS POWER (kW)	DIMENSIONS (mm)			
	(1)	(#)	(*)	DEEP ME. HIGH-CAPACITY DIUM									
CCO-120-L-ECO	50	19046991	L	<50°	80	100	120		210	10.7	48	1,180 x 790 x 1,550	-
CCO-120-R-ECO	50	19046990	R										
CCO-160-L-ECO	50	19048253	L	<50°	100	130	160		240	10.7	48	1,180 x 790 x 1,550	-
CCO-160-R-ECO	50	19048256	R										

(#) Note:  
The generator is already included in the price of the dishwasher. When ordering, the GWB-40 generator code must be added to the machine code.

(1): Consult other possible factory versions.  
(\*) Entry of baskets:  
L: Entrance from the Left of the machine.  
R: Entrance from the Right of the machine.

(\*\*) Internal zones  
 LP: Main wash.  
 A-ECO: Double effect rinse.

## Gas hot water generator GWB-40

MODEL	CODE (1)	DESCRIPTION	POWER (kW)	DIMENSIONS (mm)	€
GWB-40	LPG 50 Hz - 19011596 GN 50 Hz - 19038585	GAS HOT WATER GENERATOR Forced draught burner and double safety valve. Electronic control of temperature and water levels. Automatic limescale removal. Automatic tank emptying.	40,00	432x548x770	-

Consult other possible factory versions.

# Complementary modules for compact conveyor dishwashers

AS-260



CRS-600



CDT-600



## Factory assembly options on request

MODEL	HZ	CODE	DESCRIPTION	POWER (kW)	DIMENSIONS (mm)	€
<b>OPTION AT THE ENTRANCE TO SELECT FROM</b>						
AS-260	-	19048568	ANTI-SPLASH GUARD SUPPLEMENT (ENTER) With fitting for connection of fume extractor. With separator curtains. Includes extra anti-entrapment protection element. Fitted as standard at the entrance of modular dishwashers. This item cannot be installed on dishwashers fitted with energy recovery (CRS)	-	L = 260 mm	-
CRS-600	50/60	19048639	CONVEYOR RECOVERY SYSTEM: Recommended for models with cold water input (CW) Aspires the steam generated inside the tunnel and sends the condensed water to the tank of the machine increasing the water temperature from 15/18 °C to 35/40 °C. Allows savings of up to 3 kW-h. Recommended for models with cold water input (CW) with temperatures no higher than 25 °C. It is not appropriate for installation in machines with hot water input, nor in ECO models with rinse water heating in the GWB-40 generator. Module with conveyance system included. With separator curtains. Bottom shelf. This item cannot be installed on dishwashers fitted with anti-splash guard supplement at the entrance (AS-260).	0,75	600x790x1.930	-
<b>OPTION AT THE EXIT TO SELECT FROM</b>						
CDT-600	50/60	19046516	DRYING TUNNEL :Supplementary element with 9 kW heating element box and upper fan for drying of the dishes with 0.55 kW motor. Module with conveyance system included, for placement at the end of the machine. With separator curtains. Bottom shelf. This item cannot be installed on dishwashers fitted with anti-splash guard supplement at the exit (ASE-260). A maximum of one drier per machine can be installed.	9,55	600x790x1.930	-
ASE-260	-	19076633	ANTI-SPLASH GUARD SUPPLEMENT (EXIT) With fitting for connection of fume extractor. With separator curtains. Includes extra anti-entrapment protection element. Optional on all compact or modular rack-type dishwashers. This item cannot be installed on dishwashers fitted with CDT drying.	-	L = 260 mm	-

## Disassembled accessories

MODEL	HZ	CODE	DESCRIPTION	POWER (kW)	DIMENSION (mm)	€
KIT CDT-600 MODULE L	50/60	19056095	DRYING TUNNEL: Supplementary element with 9 kW heating element box and upper fan for drying of the dishes with 0.55 kW motor. Module with conveyance system included, for placement at the end of the machine. With separator curtains. Bottom shelf. A maximum of one drier per machine can be installed.	9,55	600x790x1.930	-
KIT CDT-600 MODULE R	50/60	19086106				

## Transformations to other voltages

VOLTAGE	CHARACTERISTICS	€
400- 440V 3~ (RC-C)	400- 440V 3~ connection for ships in Compact rack type dishwashers	-
220-240V 3~ (RC)	220-240V 3~ connection for rack type dishwashers	-



# Pack for compact drag dishwashers



CCO-120 PACK L CW



	Model	Code		
Dishwasher	CCO-120 L CW	19045325		
Anti-salp.	AS-260	19048568	CCO-120 PACK L CW	19068300
Drying tunnel	CDT-600	19046516		
Dishwasher	CCO-120 R CW	19046527		
Anti-salp.	AS-260	19048568	CCO-120 PACK R CW	19068304
Drying tunnel	CDT-600	19046516		
Dishwasher	CCO-160 L CW	19048231		
Anti-salp.	AS-260	19048568	CCO-160 PACK L CW	19068305
Drying tunnel	CDT-600	19046516		
Dishwasher	CCO-160 R CW	19048254		
Anti-salp.	AS-260	19048568	CCO-160 PACK R CW	19068306
Drying tunnel	CDT-600	19046516		

Note: the packs are not equipped for the installation of introductors of baskets in corner or automatized unloading curves.

MODEL	CODE	ENTRANCE	HZ (1)	PRODUCTION		WATER	POWER	DIMENSIONS	€
				Speed No.	Baskets/h				
CCO-120 PACK L CW	19068300	LEFT	50	3	120	210	38,00	2.040x790x1.930	-
CCO-120 PACK R CW	19068304	RIGHT	50	3	120	210	38,00	2.040x790x1.930	-
CCO-160 PACK L CW	19068305	LEFT	50	3	160	240	41,00	2.040x790x1.930	-
CCO-160 PACK R CW	19068306	RIGHT	50	3	160	240	41,00	2.040x790x1.930	-

(1): Consult other possible factory versions.

## CONCEPT

# Rack conveyor | Modular dishwashers

CCO-180-L



- All the main parts are manufactured in AISI-304 anti-corrosion stainless steel: tanks, washing and rinsing arms, rinsing jets, doors, basket conveyance system, boiler and metal tubes.
- Upwards-opening double panel door.
- Tank tray filters made of AISI-304 stainless steel, easy to access and remove for cleaning and access to the tank.
- Safety filter for pump suction.
- Rinsing boiler with heat insulation.
- Easy access for installation. Electrovalve located on one side (no need to remove panels to connect the machine).
- Electrical panel designed for easy connection of dosers for liquid and solid detergents, rinse aid, limit switches, supplementary emergency stop button.
- Washing arms easily removable as a set, for cleaning, with a plug on each branch providing access for cleaning inside.
- Rinse jets easily dismantlable and removable.
- System of electronic regulation of speeds by means of frequency shifter.

- Configurable electronic temperature control:
  - Wash (50 - 65 °C)
  - Rinse (70 - 85 °C)
- Guarantor of rinse at 85 °C.
- Pressure regulator for flow control.
- Emergency stop button incorporated.
- Extra anti-entrapment protection system at the entrance, mounted on the AS-260 splash guard supplement, as standard.
- Open door blocking system.
- IPX4 protection system.
- System for detection of blockage of conveyor carriage and automatic reverse function.
- Prewash module with 3 upper and 3 lower washing branches.
- High-power washing system with 5 upper and 5 lower washing branches.
- 3 washing programs: intensive (DIN10534), medium and high-capacity.
- Pre-rinse and rinse, both double effect, in models 180, 225 and 270.

- Triple-effect pre-rinse and double-effect rinse in model 320.
- Energy-saving system: reduces consumption by halting operation of the pumps, and by passing the heating of the rinse to stand-by mode (70 °C).
- Auto-timer which deactivates the conveyor motor after a pre-set period of inactivity (10 minutes).
- Energy saving system in the wash: the wash does not start up until it detects the passage of the basket.
- Rinse saving system. The rinse stops which the basket has left, saving water and energy.
- Limit switch included.

- Equipment included:
- 2 base baskets, CT-10
  - 2 baskets for plates CP-16/18
  - 1 basket for glasses CV-16/105
  - 1 basket for cutlery CT-10 R

MODEL	HZ (1)	CODE	ENTRANCE (*)	WATER SUPPLY	PROGRAMS (BASKETS/H)	MODULES CONSUMPTION (**)	WATER CONSUMPTION (L/H)	ELECTRICAL POWER (KW)	DIMENSIONS (mm)	€
CCO-180-L-HW	50	19048582	L	>50°	90 135 180	AS-260 + LP + DA	210	25.7	1,750 x 790 x 1,550	-
CCO-180-R-HW	50	19048587	R	>50°	90 135 180	AS-260 + LP + DA	210	25.7	1,750 x 790 x 1,550	-
CCO-180-L-CW	50	19047209	L	<50°	90 135 180	AS-260 + LP + DA	210	34.7	1,750 x 790 x 1,550	-
CCO-180-R-CW	50	19047164	R	<50°	90 135 180	AS-260 + LP + DA	210	34.7	1,750 x 790 x 1,550	-
CCO-225-L-HW	50	19048595	L	>50°	125 175 225	AS-260 + PL3+LP+DA	210	35.9	2,360 x 790 x 1,550	-
CCO-225-R-HW	50	19048212	R	>50°	125 175 225	AS-260 + PL3+LP+DA	210	35.9	2,360 x 790 x 1,550	-
CCO-225-L-CW	50	19048119	L	<50°	125 175 225	AS-260 + PL3+LP+DA	210	44.9	2,360 x 790 x 1,550	-
CCO-225-R-CW	50	19048120	R	<50°	125 175 225	AS-260 + PL3+LP+DA	210	44.9	2,360 x 790 x 1,550	-

Consult other possible factory versions.

- (\*) Entry of baskets:
- L: Entrance from the Left of the machine.
- R: Entrance from the Right of the machine.
- (\*\*) COMPOSITION OF MODULES

The diagrams and composition indicated always refer to the left-entry version.

- AS-260: Anti-splash guard supplement
- PL3: Cold water prewash
- PL5: First Wash with cold water
- L5: First wash with hot water
- LP: Main wash
- DA: Double-effect rinse and pre-rinse
- TA: Double-effect rinse and triple-effect pre-rinse

# Rack conveyor | Modular dishwashers

CCO-320-L



## General Characteristics

- All the main parts are manufactured in AISI-304 anti-corrosion stainless steel: tanks, washing and rinsing arms, rinsing jets, doors, basket conveyance system, boiler and metal tubes.
- Upwards-opening double panel door.
- Tank tray filters made of AISI-304 stainless steel, easy to access and remove for cleaning and access to the tank.
- Safety filter for pump suction.
- Rinsing boiler with heat insulation.
- Easy access for installation. Electrovalve located on one side (no need to remove panels to connect the machine).
- Electrical panel designed for easy connection of dosers for liquid and solid detergents, rinse aid, limit switches, supplementary emergency stop button.
- Washing arms easily removable as a set, for cleaning, with a plug on each branch providing access for cleaning inside.
- Rinse jets easily dismountable and removable.
- System of electronic regulation of speeds by means of frequency shifter.

- Configurable electronic temperature control:
  - Wash (50 - 65 °C)
  - Rinse (70 - 85 °C)
- Guarantor of rinse at 85 °C.
- Pressure regulator for flow control.
- Emergency stop button incorporated.
- Extra anti-entrapment protection system at the entrance, mounted on the AS-260 splash guard supplement, as standard.
- Open door blocking system.
- IPX4 protection system.
- System for detection of blockage of conveyor carriage and automatic reverse function.
- Prewash module with 3 upper and 3 lower washing branches.
- High-power washing system with 5 upper and 5 lower washing branches.
- 3 washing programs: intensive (DIN10534), medium and high-capacity.
- Pre-rinse and rinse, both double effect, in models 180, 225 and 270.

- Triple-effect pre-rinse and double-effect rinse in model 320.
- Energy-saving system: reduces consumption by halting operation of the pumps, and by passing the heating of the rinse to stand-by mode (70 °C).
- Auto-timer which deactivates the conveyor motor after a pre-set period of inactivity (10 minutes).
- Energy saving system in the wash: the wash does not start up until it detects the passage of the basket.
- Rinse saving system. The rinse stops which the basket has left, saving water and energy.
- Limit switch included.

- Equipment included:
- 2 base baskets, CT-10
  - 2 baskets for plates CP-16/18,
  - 1 basket for glasses CV-16/105,
  - 1 basket for cutlery CT-10 R

MODEL	HZ (1)	CODE	ENTRANCE WATER		PROGRAMS (BASKETS/H)			MODULES CONSUMPTION (**)	WATER SUMPTION (L/H)	ELECTRICAL POWER (KW)	DIMENSIONS (mm)	€
			(*)	SUPPLY	INTENSIF (DIN-10534)	MEDIUM	HIGH-CAPACITY					
CCO-270-L-HW	50	19048608	L	>50°	140	205	270		240	39,9	2,660 x 790 x 1,550	-
CCO-270-R-HW	50	19048614	R	>50°	140	205	270		240	48,9	2,660 x 790 x 1,550	-
CCO-270-L-CW	50	19048606	L	<50°	140	205	270		240	48,9	2,660 x 790 x 1,550	-
CCO-270-R-CW	50	19048612	R	<50°	140	205	270		240	48,9	2,660 x 790 x 1,550	-
CCO-320-L-HW	50	19048621	L	>50°	170	245	320		240	47,1	3,260 x 790 x 1,550	-
CCO-320-R-HW	50	19048630	R	>50°	170	245	320		240	47,1	3,260 x 790 x 1,550	-
CCO-320-L-CW	50	19048618	L	<50°	170	245	320		240	56,1	3,260 x 790 x 1,550	-
CCO-320-R-CW	50	19048627	R	<50°	170	245	320		240	56,1	3,260 x 790 x 1,550	-

Consult other possible factory versions. Entry of baskets:  
Entrance from the Left of the machine.  
Entrance from the Right of the machine.  
COMPOSITION OF MODULES  
The diagrams and composition indicated always refer to the left-entry version.

- AS-260: Anti-splash guard supplement
- PL3: Cold water prewash
- PL5: First Wash with cold water
- L5: First wash with hot water
- LP: Main wash
- DA: Double-effect pre-rinse and rinse
- TA: Triple-effect pre-rinse and double-effect rinse

# Modular | Dishwashers "ECO" version - gas heated

CCO-225-L-ECO + GWB-40



## Specific characteristics

- The ECO version conveyor dishwashers are fitted with an external hot water generator, gas heated, model GWB-40 (#).
- The generator replaces the electric rinse boiler in the dishwasher, bringing a significant saving in electricity consumption.

- Given the heating power of the generator, the dishwasher is for installation in facilities with a cold water connection.
- The dishwasher has a motor pump to send the water from the generator to the rinse jets.

- The dishwasher incorporates a flow regulator to ensure constant water consumption.
- The first filling of the dishwasher wash tank takes place with water both from the generator and from the filling electrovalve.

MODEL	HZ (1)	CODE	ENTRANCE WATER	PROGRAMS (BASKETS/H)	MODULES CONSUMPTION (**)	WATER CONSUMPTION (L/H)	ELECTRICAL POWER (KW)	GAS POWER (KW)	DIMENSIONS (mm)	€			
			(*)	RED INTENSIF (DIN-10534) MEDIUM HIGH CAPACITY									
CCO-180-L-ECO	50	19048584	L	<50°	90	135	180		210	19,7	48	1.750 x 790 x 1.550	-
CCO-180-R-ECO	50	19048591	R	<50°	90	135	180		210	19,7	48	1.750 x 790 x 1.550	-
CCO-225-L-ECO	50	19048597	L	<50°	125	175	225		210	20,9	48	2.360 x 790 x 1.550	-
CCO-225-R-ECO	50	19048602	R	<50°	125	175	225		210	20,9	48	2.360 x 790 x 1.550	-
CCO-270-L-ECO	50	19048610	L	<50°	140	205	270		240	21,9	48	2.660 x 790 x 1.550	-
CCO-270-R-ECO	50	19048616	R	<50°	140	205	270		240	21,9	48	2.660 x 790 x 1.550	-
CCO-320-L-ECO	50	19048624	L	<50°	170	245	320		240	29,1	48	3.260 x 790 x 1.550	-
CCO-320-R-ECO	50	19048633	R	<50°	170	245	320		240	29,1	48	3.260 x 790 x 1.550	-

(1) Consult other possible factory versions.  
(#) Note on codes  
The generator is already included in the price of the dishwasher. When ordering, the GWB-40 generator code must be added to the machine code.

(\*) Entry of baskets:  
L: Entrance from the Left of the machine.  
R: Entrance from the Right of the machine.

(\*\*) COMPOSITION OF MODULES  
The diagrams and composition indicated always refer to the left-entry version.

- AS-260: Anti-splash guard supplement
- PL3: Cold water prewash
- PL5: First Wash with cold water
- L5: First wash with hot water
- LP: Main wash
- DA: Double-effect rinse and pre-rinse
- TA: Double-effect rinse and triple-effect pre-rinse

## Gas hot water generator GWB-40

MODEL	CODE (1)	DESCRIPTION	POWER (KW)	DIMENSIONS (mm)	€
GWB-40	LPG 50 Hz -19011596 GN 50 Hz - 19038585	GAS HOT WATER GENERATOR Forced draught burner and double safety valve. Electronic control of temperature and water levels. Automatic limescale removal. Automatic tank emptying.	40,00	432x548x770	-

(1) Consult other possible factory versions.

# Complementary modules for modular conveyor dishwashers

CRS-700 L



CDT-600



Factory assembly options on request

MODEL	CODE	DESCRIPTION	POWER (KW)	DIMENSIONS (mm)	€
-------	------	-------------	------------	-----------------	---

OPTION AT THE ENTRANCE

	(*) CRS-700-L CRS-700-R	19056031 19048641	UPPER ENERGY RECOVERY Recommended for dishwashers with cold water inlet (CW) with temperatures not exceeding 25 °C. It aspirates the steam generated inside the tunnel and sends the condensed water to the tanks of the machine, increasing the water temperature from 15/18 °C to 35/40 °C. Save up to 3 kW-h. Fitted into the top of the dishwasher. Does not increase length. Its installation does not proceed in machines with hot water inlet, nor in ECO models with rinse water heating in the GWB-40 generator.	0,55	600x790x500	-
--	-------------------------------	----------------------	--	------	-------------	---

OPTION AT THE EXIT TO SELECT FROM

	CDT-600	19046516	SHORT DRYING TUNNEL FOR MODELS 180 AND 225 Supplementary element with 9 kW heating element box and upper fan for drying of the dishes with 0,55 kW motor. Module with conveyance system included, for placement at the end of the machine. With separator curtains. Bottom shelf. This element cannot be installed in a dishwasher equipped with exist anti-splash guard supplement (ASE-260). A maximum of one drier per machine can be installed.	9,55	600x790x1.930	-
	CDT-800	19047215	LONG DRYING TUNNEL FOR MODELS 270 AND 320 Supplementary element with 13.5 kW heating element box and upper fan for drying of the dishes with 1.1 kW motor. Module with conveyance system included, for placement at the end of the machine. With separator curtains. Bottom shelf. A maximum of one drier per machine can be installed. This element cannot be installed in a dishwasher equipped with exist anti-splash guard supplement (ASE-260).	14,6	800x790x1.930	-
	ASE-260	19076633	ANTI-SPLASH GUARD SUPPLEMENT (EXIT) With fitting for connection of fume extractor. With separator curtains. Includes extra anti-entrapment protection element. Optional on all compact or modular rack-type dishwashers. This item cannot be installed on dishwashers fitted with CDT drying.	-	L = 260 mm	-

(\*) Entry of baskets: L: Entrance from the Left of the machine. R: Entrance from the Right of the machine.

Dissassembled accesories

MODEL	HZ	CODE	DESCRIPTION	POWER (KW)	DIMENSIONS (mm)	€
	KIT CDT-600 MODULE L	50/60 19056095	SHORT DRYING TUNNEL FOR MODELS 180 AND 225 Supplementary element with 9 kW heating element box and upper fan for drying of the dishes with 0,55 kW motor. Module with conveyance system included, for placement at the end of the machine. With separator curtains. Bottom shelf. This element cannot be installed in a dishwasher equipped with exist anti-splash guard supplement (ASE-260). A maximum of one drier per machine can be installed.	9,55	600x790x1.930	-
	KIT CDT-600 MODULE R	50/60 19086106	SHORT DRYING TUNNEL FOR MODELS 180 AND 225 Supplementary element with 9 kW heating element box and upper fan for drying of the dishes with 0,55 kW motor. Module with conveyance system included, for placement at the end of the machine. With separator curtains. Bottom shelf. This element cannot be installed in a dishwasher equipped with exist anti-splash guard supplement (ASE-260). A maximum of one drier per machine can be installed.	9,55	600x790x1.930	-
	KIT CDT-800 MODULE L	50/60 19056098	LONG DRYING TUNNEL FOR MODELS 270 AND 320: Supplementary element with 13.5 kW heating element box and upper fan for drying of the dishes with 1.1 kW motor. Module with conveyance system included, for placement at the end of the machine. With separator curtains. Bottom shelf. This element cannot be installed in a dishwasher equipped with exist anti-splash guard supplement (ASE-260). A maximum of one drier per machine can be installed.	14,6	800x790x1.930	-
	KIT CDT-800 MODULE R	50/60 19086108	LONG DRYING TUNNEL FOR MODELS 270 AND 320: Supplementary element with 13.5 kW heating element box and upper fan for drying of the dishes with 1.1 kW motor. Module with conveyance system included, for placement at the end of the machine. With separator curtains. Bottom shelf. This element cannot be installed in a dishwasher equipped with exist anti-splash guard supplement (ASE-260). A maximum of one drier per machine can be installed.	14,6	800x790x1.930	-

Transformations to other voltages

VOLTAGE	CHARACTERISTICS	€
400- 440V 3~ (RC-M)	400- 440V 3~ connection for ships in Modular rack type dishwashers	-
220-240V 3~ (RC)	220-240V 3~ connection for rack type dishwashers	-



Composition of a conveyance train with complementary modules:  
CCO-320-L + CDT-800 + CRS-700-L  
The CRS-700-L energy recycler is located at the top and does not increase the length of the machine.

MÓDULO	COMPACT		MODULAR			
	CCO-120	CCO-160	CCO-180	CCO-225	CCO-270	CCO-320
Supplementary Anti-splash + anti-entrapment protection at the entrance	AS-260	o	o	•	•	•
Prewash	PL3	-	-	•	-	•
Intense prewash	PL5	-	-	-	•	-
First wash	L5	-	-	-	-	•
Main wash	LP	•	•	•	•	•
Double effect rinse	A	•	•	-	-	-
Double effect ECO rinse	A-ECO	o	o	-	-	-
Double effect pre-rinse + Double effect rinse	DA	-	-	•	•	•
Double effect pre-rinse + Double effect ECO rinse	DA-ECO	-	-	o	o	o
Triple effect pre-rinse + Double effect rinse	TA	-	-	-	-	•
Triple effect pre-rinse + Double effect ECO rinse	DA / TA-ECO	-	-	-	-	o
Drying Module 600	CDT-600	o	o	o	o	-
Drying Module 800	CDT-800	-	-	-	-	o
Energy recycler for compact models	CRS-600	o	o	-	-	-
Energy recycler for modular dishwashers	CRS-700	-	-	o	o	o
Supplementary anti-splash guard at the exit	ASE-260	o	o	o	o	o

x: Standard - : o: Optional

All the modular machines come with an anti-splash module AS-260 at the entrance as standard, 260 mm in length. An exterior extractor can be fitted to this module. Optionally, you can also request it as a supplement to fit to the exit of the machine.

The CDT drying tunnels are fitted to the exit of the machine, increasing the total length by 600 or 800 mm (depending on the model of drying tunnel installed). For models 270 and 320, the long CDT-800 drying tunnel is to be installed.

The CRS-700 energy recycler is to be placed on top of the modular dishwashers, and the total length is not increased. Recommended for models with cold water input (CW) with temperatures no higher than 25 °C. It is not appropriate for installation in machines with hot water input, nor in ECO models with rinse water heating in the GWB-40 generator.

The mission of this accessory is to collect the steam from the inside of the dishwasher, and, after a process of condensation, send this water (which is at high temperature) to the rinse system. This raises the average temperature in the rinse system, which therefore requires a lower supply of electrical energy, contributing to notable savings in energy and costs (around 3 kW-h).

## Summary table of characteristics for conveyor dishwashers

	CCO-120	CCO-160	CCO-180	CCO-225	CCO-270	CCO-320
Speeds	3	3	3	3	3	3
Production (baskets/h)						
Deep wash program	80	100	-	-	-	-
Intensive program (DIN-10534)	-	-	90	125	140	170
Medium program	100	130	135	175	225	245
High-capacity program	120	160	180	225	270	320
<b>PREWASH PL3,PL5</b>						
Tank capacity (l)	-	-	-	60	100	60
Pump power (kW)	-	-	-	1,2	2,2	1,2
<b>WASH L5, LP</b>						
Tank capacity (l)	50	50	100	100	100	200
Temperature (°C)	55-65	55-65	55-65	55-65	55-65	55-65
Heating power (kW)	9	9	12	12	12	18
Pump power (kW)	1.2	1.2	2.2	2.2	2.2	4.4
<b>PRE-RINSE DA, TA</b>						
Tank capacity (l)	-	-	15	15	15	15
Temperature (°C)	-	-	70	70	70	70
Heating power (kW)	-	-	5	5	5	5
Pump power (kW)	-	-	0.26	0.26	0.26	0.26
<b>RINSE</b>						
Boiler volume (l)	21	21	21	21	21	21
Temperature (°C)	80-85	80-85	80-85	80-85	80-85	80-85
Heating power (kW)						
CW	27	30	27	24	27	27
CW with recycler	24	27	24	21	24	24
HW	18	21	18	15	18	18
ECO	-	-	-	-	-	-
ECO rinse pump power (kW)	0,26	0,26	0,26	0,26	0,26	0,26
Water consumption *1						
(l/h)	210	240	210	210	240	240
(l/basket)	1.75	1.5	1.17	0.93	0.89	0.75
<b>STANDARD CONNECTION</b>						
Type of connection (default)	ALT.	ALT.	ALT.	SIM.	SIM.	SIM.
Voltage *2	400 V /3N ~ / 50 - 60Hz					
Total power (kw)						
CW	28.5	31.5	34.7	44.9	48.9	56.1
CW with recycler	26.2	29.2	32.3	42.5	46.5	53.7
HW	19.5	22.5	25.7	35.9	39.9	47.1
ECO	10.7	10.7	19.7	20.9	21.9	29.1
ECO gas booster (gas kW)	38	38	38	38	38	38
<b>WIDTH (mm)</b>						
Standard	1180	1180	1760	2360	2660	3260
With drying module	1780	1780	2360	2960	3460	4060
Depth (mm)	790	790	790	790	790	790
<b>HEIGHT (mm) *3</b>						
Standard	1550-1610	1550-1610	1550-1610	1550-1610	1550-1610	1550-1610
With drying	1860-1920	1860-1920	1860-1920	1860-1920	1860-1920	1860-1920
With recycler	1960-2020	1960-2020	1960-2020	1960-2020	1960-2020	1960-2020
With open door blocking system	1870-1930	1870-1930	1870-1930	1870-1930	1870-1930	1870-1930
Operating height (mm)	850-900	850-900	850-900	850-900	850-900	850-900
Useful entrance height (mm)	390	390	390	390	390	390
Passage width (mm)	510	510	510	510	510	510
<b>WEIGHT (KG)</b>						
Net	211	211	259	381	434	556
Gross	305	305	382	556	628	792
<b>WATER CONNECTION</b>						
Operating pressure	2 - 4 bars					
Type of connection	3/4" GAS					
Tª of hot water	50 °C - 60 °C					
Tª of cold water	15 °C - 50 °C					

\*1 - Non-binding information Consumption might vary depending on the characteristics of the facility

\*2 - Standard voltage: 400 V 3+N - For other voltages and options, please consult Fagor Professional

\*3 - The adjustable feet allow for height adjustment, raising the machine by up to 60 mm

## Pre-rinsing tables

MFDB-1200 LM-D,  
model, with sink and shower tap

## General characteristics

- Manufactured for the compact and modular conveyor dishwashers.

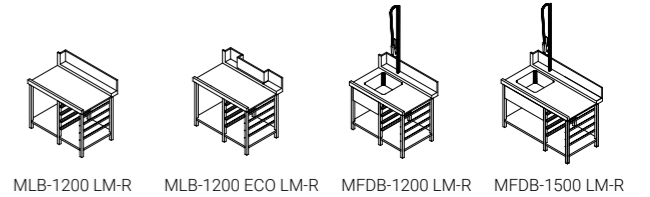

MODEL	CODE	ENTRY (*)	EQUIPMENT FEATURES	DIMENSIONS (mm)	€
MLB-1200 LM-R	19006097	R	- Rear guard - Lower rack - Guides for baskets	1.200x800x900	-
MLB-1200 LM-L	19006096	L			
MLB-1200 ECO/LM-R	19006099	R	- Rear guard - Lower rack - Guides for baskets - Hole for chimney of GWB-40	1.200x800x900	-
MLB-1200 ECO/LM-L	19006098	L			
MFDB-1200 LM-R	19006104	R	- Rear guard - Sink - Shower tap - Lower rack - Guides for baskets	1.200x800x900	-
MFDB-1200 LM-L	19006105	L			
MFDB-1500 LM-R	19006404	R	- Rear guard - Sink - Shower tap - Lower rack - Guides for baskets	1.500x800x900	-
MFDB-1500 LM-L	19006405	L			

(\*) Entrance of the baskets:  
L: Entry from the left side of the machine.  
R: Entrance from the right side of the machine.

## Delivery / sorting tables



## General characteristics

- Serving staff can deposit dirty dishes while the dishwashing staff are sorting them on the other side.
- The table is supplied with a sorting shelf (450 mm over the work top) and a waste disposal.
- Adjustable feet.

MODEL	CODE	SHELF DIMENSIONS (mm)	SHELF CAPACITY (BASKETS)	DIMENSIONS (mm)	€
MD3C	19006410	1.530x600	3	1.600x800x1.642	-
MD4C	19006509	2.030x600	4	2.100x800x1.642	-



## Delivery / sorting tables

M FDP-1800 LM-L



### General characteristics

- Manufactured for the compact and modular conveyor dishwashers.
- Rear guard in all the models.
- Waste disposal.
- Space for the trash bin.
- Tables with sink built-in shower tap.

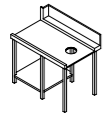

MLH-1200 LM-R

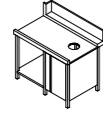

MLP-1200 LM-R

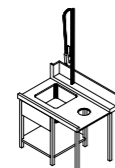

MFDH-1200 LM-R

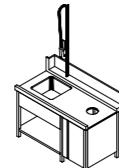

M FDP-1500 LM-R

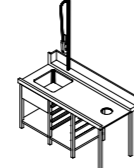

MFDH-1800 LM-R

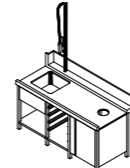

M FDP-1800 LM-R

MODEL	CODE	ENTRY (*)	HOUSING FOR BIN	CHARACTERISTICS	DIMENSIONS (mm)	€
MLH-1200 LM-R	19006100	R	OPEN	- Lower rack	1.200x800x900	-
MLH-1200 LM-L	19006101	L				
MLP-1200 LM-R	19006102	R	DOOR	- Lower rack	1.200x800x900	-
MLP-1200 LM-L	19006103	L				
MFDH-1200 LM-R	19006106	R	OPEN	- Sink - Shower tap - Lower rack	1.200x800x900	-
MFDH-1200 LM-L	19006107	L				
M FDP-1200 LM-R	19006108	R	DOOR	- Sink - Shower tap - Lower rack	1.200x800x900	-
M FDP-1200 LM-L	19006109	L				
MFDH-1500 LM-R	19006408	R	OPEN	- Sink - Shower tap - Lower rack	1.500x800x900	-
MFDH-1500 LM-L	19006407	L				
M FDP-1500 LM-R	19006409	R	DOOR	- Sink - Shower tap - Lower rack	1.500x800x900	-
M FDP-1500 LM-L	19006406	L				
MFDH-1800 LM-R	19006506	R	OPEN	- Sink - Shower tap - Lower rack - Guides for baskets	1.800x800x900	-
MFDH-1800 LM-L	19006507	L				
M FDP-1800 LM-R	19006508	R	DOOR	- Sink - Shower tap - Lower rack - Guides for baskets	1.800x800x900	-
M FDP-1800 LM-L	19006505	L				



(\*) Entrance of the baskets:  
L: Entry from the left side of the machine.  
R: Entrance from the right side of the machine.

## Pre-rinsing table with introducer of baskets in corner

M CFD-1000 R

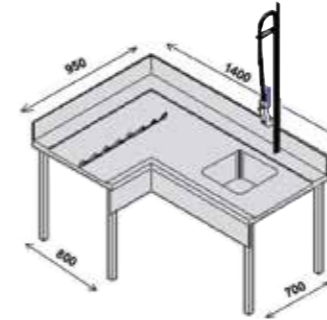

### General characteristics

- Rear guard 200 mm. Built in sink and shower tap.
- Length of the sink side: 1,400 mm - Depth: 700 mm.
- Element to introduce the baskets with the movement of the advancement system of the conveyor.
- Length of the introducer side: 950 mm - Depth: 800 mm.
- Ask the manufacturer to adapt the machine to install the table.

MODEL	CODE	ENTRY (*)	EQUIPMENT FEATURES	DIMENSIONS (mm)
M CFD-1000 R	19006350	R	- Rear guard - Sink - Shower tap - Introducer	1.400x950x900
M CFD-1000 L	19006351	L		



(\*) Entrance of the baskets:  
L: Entry from the left side of the machine.  
R: Entrance from the right side of the machine.

## Introducers of baskets in corner

E-90-R-CV

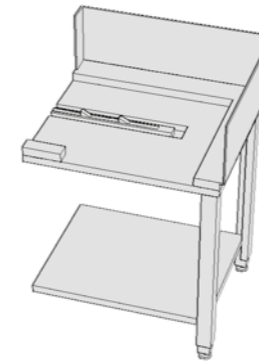

### General characteristics

- Element to introduce the baskets in the machine.
- Movement by the advancement system of the conveyor.
- Rear guard 250 mm.
- Lower shelf.
- Ask the manufacturer to adapt the machine to install the introducer.



(\*) Entrance of the baskets:  
L: Entry from the left side of the machine.  
R: Entrance from the right side of the machine.

MODEL	CODE	DESCRIPTION	DIMENSIONS (mm)	€
E-90-L	19004789	INTRODUCER OF BASKETS BY THE LEFT SIDE For rack conveyors WITH entry splash-guard (AS-260).	800x700x850	-
E-90-L-CV	19004792	INTRODUCER OF BASKETS BY THE LEFT SIDE For rack conveyors WITHOUT entry splash-guard (AS-260).	800x700x850	-
E-90-R	19004790	INTRODUCER OF BASKETS BY THE RIGHT SIDE For rack conveyors WITH entry splash-guard (AS-260).	800x700x850	-
E-90-R-CV	19004791	INTRODUCER OF BASKETS BY THE RIGHT SIDE For rack conveyors WITHOUT entry splash-guard (AS-260).	800x700x850	-
-	19003534	Basket introducer mechanism to install on a custom made introducer	-	-

## Automatized curves for exit

180-L-TS



### General characteristics

- Automatic movement with the conveyor exit system.
- Ask the manufacturer to adapt the machine to install the automatized curve.

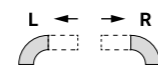

(\*) Exit of basket. It is opposite to the model of conveyor dishwasher.  
L: Exist from the left of the machine  
R: Exist from the right of the machine

MODEL	CODE	EXIT (*)	DESCRIPTION	DIMENSIONS (mm)
180-L-TS	19004788	L	AUTOMATIZED CURVE 180° AT LEFT For rack conveyors WITHOUT exit splash-guard (ASE-260). Also for models WITH DRYING TUNNEL	778x1.442x900
180-L	19004786	L	AUTOMATIZED CURVE 180° AT LEFT For rack conveyors WITH exit splash-guard (ASE-260).	778x1.442x900
180-R-TS	19004797	R	AUTOMATIZED CURVE 180° AT RIGHT For rack conveyors WITHOUT exit splash-guard (ASE-260). Also for models WITH DRYING TUNNEL	778x1.442x900
180-R	19004787	R	AUTOMATIZED CURVE 180° AT RIGHT For rack conveyors WITH exit splash-guard (ASE-260).	778x1.442x900
90-L-TS	19004795	L	AUTOMATIZED CURVE 90° AT LEFT For rack conveyors WITHOUT exit splash-guard (ASE-260). Also for models WITH DRYING TUNNEL	778x778x900
90-L	19004794	L	AUTOMATIZED CURVE 90° AT LEFT For rack conveyors WITH exit splash-guard (ASE-260).	778x778x900
90-R-TS	19004796	R	AUTOMATIZED CURVE 90° AT RIGHT For rack conveyors WITHOUT exit splash-guard (ASE-260). Also for models WITH DRYING TUNNEL	778x778x900
90-R	19004793	R	AUTOMATIZED CURVE 90° AT RIGHT For rack conveyors WITH exit splash-guard (ASE-260).	778x778x900

## Rolling tables



### General characteristics

- Removable rolling units made in ABS, Ø 40 mm.
- Easy cleaning.
- Drain outlet.
- Adjustable stainless steel legs.
- Can be connected to the automatic curves.
- Includes limit switch for connection to the dishwasher

MODEL	CODE	DESCRIPTION	CAPACITY (BASKETS)	DIMENSIONS (mm)	€
MR2C	19004901	Rolling table	2	1128x665x850	-
MR3C	19005073	Rolling table	3	1638x665x850	-
MR4C	19004902	Rolling table	4	2148x665x850	-

# Flight type dishwashers

Flight type dishwashers.....231

**Water connection:**  
It is advisable to introduce sanitary water in the dishwashers, with a temperature of 15 - 25 °C.

**Water pressure:**  
Minimum: 2 bar = 2 kg/cm<sup>2</sup>  
Maximum: 4 bar = 4 kg/cm<sup>2</sup>

**Water softener:**  
All glass / dishwashers should be connected to a treated water supply when the local supply is over 10 HF / 6 HD.

Any issues derived from a bad installation that don't meet with the indicated conditions will not be considered as a warranty.



A high performance solution.



Commercial video

Sales brochure

## Flight type dishwashers



## Common features of the range

- Wash modules without inner piping.
- Double-skin construction.
- Double-skin doors with thermal and acoustic insulation.
- Counterweighted doors with safety stops allow full unrestricted access to the pre-wash, wash, pre-rinse and rinse areas.
- Modular construction allowing the machine to be divided on site into narrower modules.
- Loading area of 763 mm and unloading area of 830 mm useful length at 900 mm height.
- 150 mm splash (AS) guard module at the loading area.
- Activation of the washing process by photocell.
- Belt drive speed controlled by a frequency converter and a micro cut-off which, in the event of any kind of blockage, stops the machine without causing any damage to it. It has an unblocking feature that reverses the belt to help clear the jam.
- Autotimer: after a period of inactivity, the traction motor is deactivated, reducing power consumption.
- Power-saving mode (stand-by): Reduction of power consumption and limescale deposition on the heating element by reducing the temperature of the boiler and tank water when the machine is not in operation.
- Automatic pre-heating system. Activation of the washing pumps and the dryers prior to reaching the setpoint temperatures to heat the environment and thus achieve a quick start-up of the machine.
- Washing tanks:
  - 100-litre tank.
  - Washing system consisting of 6 upper arms and 5 lower arms.
  - Stainless steel arms in the pre-wash and wash, removable for cleaning.
  - Triple level filtration in the wash and pre-wash modules.
  - The bottom of the tank is stamped to ensure complete draining and facilitate cleaning.
  - Thermally insulated boilers.
  - Easily removable stainless steel rinsing arms with high efficiency rinsing nozzles.
  - Adjustable steam suction system that prevents vapours from escaping.
  - Energy recovery included, located on the upper part of the machine, which allows the installed power to be reduced by 9kW.
  - Drying (D) placed on the unloading area and possibility of adding up to 2 additional dryers.
  - Curtains resistant to high temperatures and detergents, which are installed to prevent water splashing and contamination between modules.
  - Detection of belt end with stop and autostart.
  - Machine protected against water jets according to IPX5 category.

## Interface



- Electromechanical switch that allows you to choose between 3 programmes depending on the workload or dirt.
- Two digital displays for the control and visualisation of washing and rinsing temperatures.
- Unlock push button to reverse the conveyor carriage to help clear the jam and another push button to activate it.

- The conveyor carriage locking and activation push buttons are also on the loading and unloading areas.
- Emergency push buttons at the entrance and exit included.
- Main switch included.

## Useful height

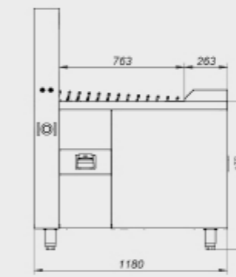
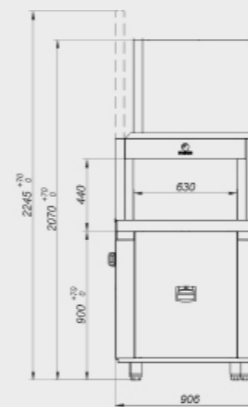

## Unloading area

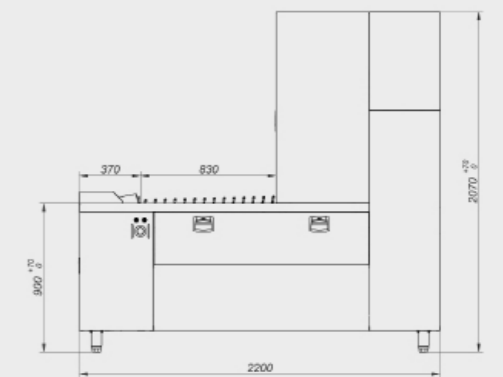

## Available belts

Belt for plates and baskets

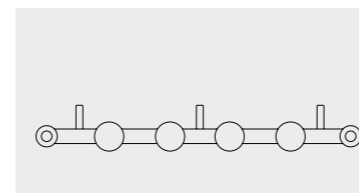

Belt for kitchenware (pots and containers)

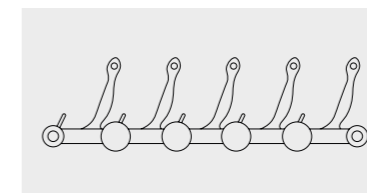

Belt for isothermal trays

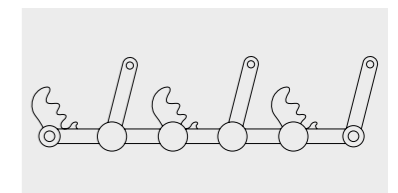



## CONCEPT

## Flight type dishwashers FCO-W4-RD

FCO-W4-RD R



## Specific features

- Electromechanical switch that allows you to choose between 3 programmes and two digital displays for the control and visualisation of washing and rinsing temperatures.
- Splash guard module (AS).
- Main wash (W).
- Prerinse / Rinse (4)
  - Pre-rinsing: Consisting of 2 upper and 1 lower prerinsing arms.
  - Rinsing: With one rinse pump. Type A non-return device in compliance with EN 1717 and WRAS approval. Consisting of 1 upper and 1 lower rinse arm. It uses a frequency converter for the rinse pump, which allows to vary the amount of rinse water by automatically adapting it to the selected conveying speed.
- Energy Recovery as standard (R).
- One standard drier (D) for optimal drying of ceramic dishes. Possibility of adding two extra dryers for drying plastic or stainless steel kitchenware

## Technical data

Height (1)	mm	2070
Height with door open	mm	2245
Clearance (WxH)	mm	630x440
Supply water pressure min. - max.	bar	1,5-4
Traction motor	kW	0,25
Tank capacity	lt	100
Tank power	kW	18
Washing pump power	kW	2,6
PRE-RINSE/RINSE	PRE-RINSE	RINSE 4
Boiler capacity	lt	20
Tank capacity	lt	30
Boiler heater power	kW	18
Tank resistance power	kW	5
Rinsing pump power	kW	0,26
DRY	DRY D	
Heater power	kW	7,5
Fan power	kW	1,95

(1) Adjustable height (+70/+0 mm)

## Programs

PROGRAM	PRODUCTION (PLATES/H)	WATER CONSUMPTION (L/H)	WASH TEMPERATURE (°C)	RINSE TEMPERATURE (°C)	TOTAL POWER (KW) (1)
					COLD WATER INLET WITH ENERGY RECOVERY (RC) 15°-25°
380-400V 3N 50Hz (1) Simultaneous					
Intensive program (DIN-10534)	1575	190	65	85	53,8
Medium program	2325	210	65	85	53,8
High capacity program	3100	230	65	85	53,8

(1) Consult other possible factory versions.

## Codes and prices \*

CODE	MODEL	ENTRY DIRECTION	€
19073687	FCO-W4-RD R	Right	-
19075203	FCO-W4-RD L	Left	-

\* The price of the machine does not include the belt, which must be ordered separately. See options and accessories.

## Belts

CODE	MODEL	DESCRIPTION	€
19072468	PLATE BELT FCO-W4-RD	Belt for plates and baskets	-
19072498	KITCHENWARE BELT FCO-W4-RD	Belt for kitchenware (pots and containers)	-
19072497	ISOTHERMAL TRAY BELT FCO-W4-RD	Belt for isothermal trays	-

## Extra drying

CODE	MODEL	VOLTAGE AND FREQUENCY (HZ)	DESCRIPTION	POWER (KW)	DIMENSIONS (MM)	€
19075207	FDM-700	400V 3N 50/60	Extra drying	9,5	700x900x2070	-

One standard drier (D) for optimal drying of ceramic dishes. Possibility of adding two extra dryers for drying plastic or stainless steel kitchenware.



## Disassembly

CODE	MODEL	DESCRIPTION	€
19075212	BELT MODULE DISASSEMBLY KIT	Extra charge for disassembly and shipment of the machinery in several packages.bultos.	-

## Transformations to other voltages

VOLTAGE	CHARACTERISTICS	€
220-240V 3~ (FG)	220-240V 3~ connection for rack type dishwashers	

## Standard accessories

	Glass basket	ps	2
	Cutlery basket	ps	1
	Cups basket	ps	2

## CONCEPT

## Flight type dishwashers FCO-PW4-RD

FCO-PW4-RD R



## Specific features

- Electromechanical switch that allows you to choose between 3 programmes and two digital displays for the control and visualisation of washing and rinsing temperatures.
- Splash guard module (AS).
- Pre-wash (P): Consisting of 6 upper arms and 5 lower arms. Continuous renewal of the pre-wash water with a constant amount of pre-rinse water, channelling the surplus through a recirculation pump.
- Main wash (W).
- Pre-rinsing / rinsing (4)
  - Pre-rinsing: Consisting of 2 upper and 1 lower prerinsing arms.
  - Rinsing: With one rinsing pump. Type A non-return device in compliance with EN 1717 and WRAS approval. Consisting of 1 upper and 1 lower rinsing arm. It uses a frequency converter for the rinse pump, which allows to vary the amount of rinse water by automatically adapting it to the selected conveying speed.
- Energy Recovery as standard (R).
- One standard drier (D) for optimal drying of ceramic dishes. Possibility of adding two extra dryers for drying plastic or stainless steel kitchenware.

## Technical data

Height (1)	mm	2070
Height with door open	mm	2245
Clearance (WxH)	mm	630x440
Supply water pressure min. - max.	bar	1,5-4
Traction motor	kW	0,25
PRE-WASH/WASH	PRE-WASH P	MAIN WASH W
Tank capacity	lt	100
Tank heater power	kW	15
Washing pump power	kW	2,6
PRE-RINSE/RINSE	PRE-RINSE	RINSE 4
Boiler capacity	lt	20
Tank capacity	lt	30
Boiler heater power	kW	18
Tank resistance power	kW	5
Rinsing pump power	kW	0,26
DRY	DRY D	
Heater power	kW	7,5
Fan power	kW	1,95

(1) Adjustable height (+70/+0 mm)

## Programs

PROGRAM	PRODUCTION (PLATES/H)	WATER CONSUMPTION (L/H)	WASH TEMPERATURE (°C)	RINSE TEMPERATURE (°C)	TOTAL POWER (KW) (1)
					COLD WATER INLET WITH ENERGY RECOVERY (RC) 15°-25°
Intensive program (DIN-10534)	2490	190	65	85	53,4
Medium program	3520	210	65	85	53,4
High capacity program	4600	230	65	85	53,4

(1) Consult other possible factory versions.

## Options and accessories

## Codes and prices \*

CODE	MODEL	ENTRY DIRECTION	€
19068360	FCO-PW4-RD R	Right	-
19068366	FCO-PW4-RD L	Left	-

\* The price of the machine does not include the belt, which must be ordered separately. See options and accessories.

## Belts

CODE	MODEL	DESCRIPTION	€
19074856	PLATE BELT FCO-PW4-RD	Belt for plates and baskets	-
19072700	KITCHENWARE BELT FCO-PW4-RD	Belt for kitchenware (pots and containers)	-
19075209	ISOTHERMAL TRAY BELT FCO-PW4-RD	Belt for isothermal trays	-

## Extra Drying

CODE	MODEL	VOLTAGE AND FREQUENCY (HZ)	DESCRIPTION	POWER (KW)	DIMENSIONS (MM)	€
19075207	FDM-700	400V 3N 50/60	Extra drying	9,5	700x900x2070	-

One standard drier (D) for optimal drying of ceramic dishes. Possibility of adding two extra dryers for drying plastic or stainless steel kitchenware.



## Disassembly

CODE	MODEL	DESCRIPTION	€
19075212	BELT MODULE DISASSEMBLY KIT	Extra charge for disassembly and shipment of the machinery in several packages.	-

## Transformations to other voltages

VOLTAGE	CHARACTERISTICS	€
220-240V 3~ (FG)	220-240V 3~ connection for rack type dishwashers	-

## Standard accessories

	Glass basket	ps	2
	Cutlery basket	ps	1
	Cups basket	ps	2

## CONCEPT

## Flight type diswashers FCO-P2W4

FCO-P2W4-RD R

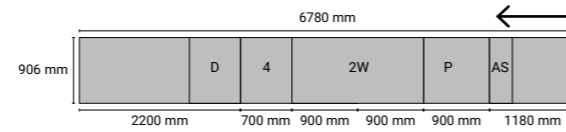

## Specific features

- Electromechanical switch that allows you to choose between 3 programmes and two digital displays for the control and visualisation of washing and rinsing temperatures.
- Splash guard module (AS).
- Pre-wash (P): Consisting of 6 upper arms and 5 lower arms. Continuous renewal of the pre-wash water with a constant amount of pre-rinse water, channelling the surplus through a recirculation pump.
- First wash and main wash (2W).
- Pre-Rinse / Rinse (4)
  - Pre-rinsing: Consisting of 3 upper and 1 lower prerinsing arms.
  - Rinsing: With one rinsing pump. Type A non-return device in compliance with EN 1717 and WRAS approval. Consisting of 1 upper and 1 lower rinsing arm. It uses a frequency converter for the rinse pump, which allows to vary the amount of rinse water by automatically adapting it to the selected conveying speed.
- Energy Recovery as standard (R).
- One standard drier (D) for optimal drying of ceramic dishes. Possibility of adding two extra dryers for drying plastic or stainless steel kitchenware.

## Technical data

Height (1)	mm	2070	
Height with door open	mm	2245	
Clearance (WxH)	mm	630x440	
Supply water pressure min. - max.	bar	1,5-4	
Traction motor	kW	0,25	
<b>WASH</b>			
		PRE-WASH P	FIRST WASH + MAIN WASH 2W
Tank capacity	lt	100	100 + 100
Tank heater power	kW		12 + 15
Washing pump power	kW	2,6	2,6 + 2,6
<b>PRE-RINSE/RINSE</b>			
		PRE-RINSE	RINSE 4
Boiler capacity	lt	-	20
Tank capacity	lt	30	-
Boiler heater power	kW	-	18
Tank resistance power	kW	5	-
Rinsing pump power	kW	0,26	0,15
<b>DRY</b>			
		DRY D	
Heater power	kW	7,5	
Fan power	kW	1,95	

(1) Adjustable height (+70/+0 mm)

PROGRAM	PRODUCTION (PLATES/H)	WATER CONSUMPTION (L/H)	WASH TEMPERATURE (°C)	RINSE TEMPERATURE (°C)	TOTAL POWER (KW) (1)
					COLD WATER INLET WITH ENERGY RECOVERY (RC) 15°-25°
380-400V 3N 50Hz (1) Simultaneous					
Intensive program (DIN-10534)	3350	220	65	85	68
Medium program	4970	245	65	85	68
High capacity program	6600	270	65	85	68

(1) Consult other possible factory versions.

## Codes and prices \*

CODE	MODEL	ENTRY DIRECTION	€
19074752	FCO-P2W4-RD R	Right	-
19073649	FCO-P2W4-RD L	Left	-

\* The price of the machine does not include the belt, which must be ordered separately. See options and accessories.

## Belts

CODE	MODEL	DESCRIPTION	€
19073644	PLATE BELT FCO-P2W4-RD	Belt for plates and baskets	-
19072701	KITCHENWARE BELT FCO-P2W4-RD	Belt for kitchenware (pots and containers)	-
19075210	ISOTHERMAL TRAY BELT FCO-P2W4-RD	Belt for isothermal trays	-

## Extra Drying

CODE	MODEL	VOLTAGE AND FREQUENCY (HZ)	DESCRIPTION	POWER (KW)	DIMENSIONS (MM)	€
19075207	FDM-700	400V 3N 50/60	Extra drying	9,5	700x900x2070	-

One standard drier (D) for optimal drying of ceramic dishes. Possibility of adding two extra dryers for drying plastic or stainless steel kitchenware



## Disassembly

CODE	MODEL	DESCRIPTION	€
19075212	BELT MODULE DISASSEMBLY KIT	Extra charge for disassembly and shipment of the machinery in several packages.	-

## Transformations to other voltages

VOLTAGE	CHARACTERISTICS	€
220-240V 3~ (FG)	220-240V 3~ connection for rack type dishwashers	-

## Standard accessories

	Glass basket	un	2
	Cutlery basket	un	1
	Cups basket	un	2

## CONCEPT

## Flight type dishwashers FCO-P3W4-RD

FCO-P2W4-RD R

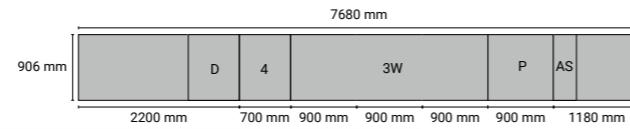

## Technical data

- Electromechanical switch that allows you to choose between 3 programmes and two digital displays for the control and visualisation of washing and rinsing temperatures.

- Splash guard module (AS).

- Pre-wash (P): Consisting of 6 upper arms and 5 lower arms.

Continuous renewal of the pre-wash water with a constant amount of pre-rinse water, channelling the surplus through a recirculation pump.

- First wash, second wash and main wash (3W)

- Pre-rinsing / Rinsing (4)

· Pre-rinsing: Consisting of 3 upper and 1 lower prerinsing arms.

· Rinsing: With one rinsing pump. Type A non-return device in compliance with EN 1717 and WRAS approval. Consisting of 1 upper and 1 lower rinsing arm. It uses a frequency converter for the rinse pump, which allows to vary the amount of rinse water by automatically adapting it to the selected conveying speed.

- Energy Recovery as standard (R).

- One standard drier (D) for optimal drying of ceramic dishes. Possibility of adding two extra dryers for drying plastic or stainless steel kitchenware.

Height (1)	mm	2070
Height with door open	mm	2245
Clearance (WxH)	mm	630x440
Supply water pressure min. - max.	bar	1,5-4
Traction motor	kW	0,25

WASH		PRE-WASH P	FIRST WASH, SECOND WASH AND MAIN WASH 3W
		Tank capacity	lt
Tank heater power	kW		12 + 12 + 15
Washing pump power	kW	2,6	2,6 + 2,6 + 2,6
PRE-RINSE/RINSE		PRE-RINSE	RINSE 4
Boiler capacity	lt	-	20
Tank capacity	lt	30	-
Boiler heater power	kW	-	18
Tank heater power	kW	5	-
Rinsing pump power	kW	0,26	0,15
DRY		DRY D	
Heater power	kW		7,5
Fan power	kW		1,95

(1) Adjustable height (+70/+0 mm)

PROGRAM	PRODUCTION (PLATES/H)	WATER CONSUMPTION (L/H)	WASH TEMPERATURE (°C)	RINSE TEMPERATURE (°C)	TOTAL POWER (KW) (1)
					COLD WATER INLET WITH ENERGY RECOVERY (RC) 15°-25°
380-400V 3N 50Hz (1) Simultaneous					
Intensive program (DIN-10534)	4275	220	65	85	82,6
Medium program	6410	245	65	85	82,6
High capacity program	8600	270	65	85	82,6

(1) Consult other possible factory versions.

## Codes and prices\*

CODE	MODEL	ENTRY DIRECTION	€
19075204	FCO-P3W4-RD R	Right	-
19075119	FCO-P3W4-RD L	Left	-

\* The price of the machine does not include the belt, which must be ordered separately. See options and accessories.

## Belts

CODE	MODEL	DESCRIPTION	€
19075208	PLATE BELT FCO-P3W4-RD	Belt for plates and baskets	-
19072707	KITCHENWARE BELT FCO-P3W4-RD	Belt for kitchenware (pots and containers)	-
19075211	ISOTHERMAL TRAY BELT FCO-P3W4-RD	Belt for isothermal trays	-

## Extra Drying

CODE	MODEL	VOLTAGE AND FREQUENCY (HZ)	DESCRIPTION	POWER (KW)	DIMENSIONS (MM)	€
19075207	FDM-700	400V 3N 50/60	Extra drying	9,5	700x900x2070	-

One standard drier (D) for optimal drying of ceramic dishes. Possibility of adding two extra dryers for drying plastic or stainless steel kitchenware



## Disassembly

CODE	MODEL	DESCRIPTION	€
19075212	BELT MODULE DISASSEMBLY KIT	Extra charge for disassembly and shipment of the machinery in several packages.	-

## Transformations to other voltages

VOLTAGE	CHARACTERISTICS	€
220-240V 3~ (FG)	220-240V 3~ connection for rack type dishwashers	-

## Standard accessories

	Glass basket	un	2
	Cutlery basket	un	1
	Cups basket	un	2



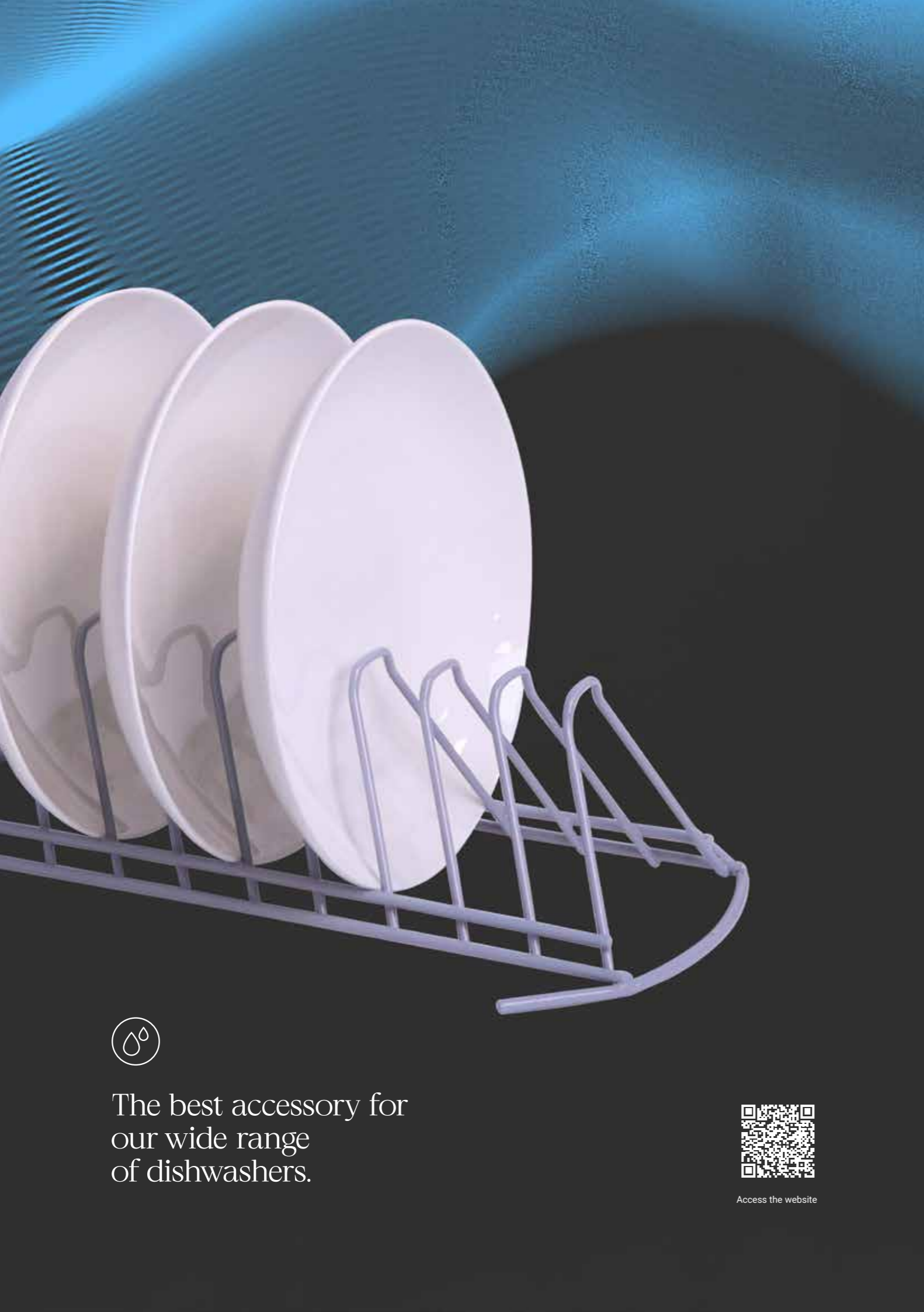

# Dishwasher accessories

Baskets .....241









The best accessory for  
our wide range  
of dishwashers.





Access the website

## Basket for crockery, cutlery and trays

	CODE	MODEL	DESCRIPTION	Ø MÁX (mm)	PRODUCT CAPACITY	DIMENSIONS (mm)	€
	19000487	CP-16/18	Plates basket	Ø 230 Ø 320	16-18 8-9	500x500x110	-
	19004479	CP-12	Deep plates basket (75 mm)	Ø 230 Ø 320	12 6	500x500x140	-
	19000484	CT-10	Glass basket	-	-	500x500x110	-
	19082432	WRPG-40	Glass basket	-	-	400x400x110	-
	19082434	WRPG-35	Glass basket	-	-	350x350x110	-
	19084452	WRWP-11	Plates insert	-	11	400x400x110	-
	19087265	CT-10 R	Cutlery basket	-	-	500x500x110	-
	19000483	CB-7	Self-service trays basket	-	7	500x500x110	-
	19000792	CU-7	Cutlery insert	-	15	105x105x130	-
	19102721	CU-GW	Cutlery insert	-	9	Ø 96x104	-

## Glass baskets

### Rod baskets

	CODE	MODEL	DIVISIONS	Ø MÁX (MM)	DIMENSIONS (MM)	€
	19107614	WRWG-40	4	92	400x400x183	-
	19107616	WRWG-50	5	92	500x500x190	-

### Plastic baskets



500x500x140





500x500x190



500x500x240



	PRODUCT CAPACITY	CODE	MODEL	€	CODE	MODEL	€	CODE	MODEL	€
	16	19000488	CV-16/105	-	19000489	CV-16/155	-	19000490	CV-16/205	-
	25	19000491	CV-25/105	-	19000492	CV-25/155	-	19000493	CV-25/205	-
	36	19000494	CV-36/105	-	19000495	CV-36/155	-	19000496	CV-36/205	-





Commercial  
Refrigeration



# A commitment to a more sustainable world.

The iKOLD generation has been designed with the kitchen professional in mind. A renewed aesthetic, perfectly integrated with the Fagor Professional brand and our Catering equipment (cooking blocks, ovens, refrigeration, neutral furniture...) for professional kitchens.

An optimized refrigeration technology, reaching highest energy efficiency index with lowest energy consumption.

Cooling devices developed with Hydrocarbon (HC) gases with Global Warming Potential (GWP) = 3, in commitment to our sustainability values.

Designed with high efficiency electronic components which guarantees high cooling performance for optimal food preservation.

Complete range of product (storage cabinets and counters, preparation counters, blast chillers, bar coolers etc...) focused on food preparation, chilling and storing.

Thus, contemplating your needs and our experience as the first manufacturer of Commercial Refrigeration in Europe, the iKOLD generation was born.



### Efficiency

Low impact and up to 65% lower consumption.



### Performance

Durability and quality, guarantee of preservation for your food.



### Versatility

Wide range of solutions for your kitchen.



### Sustainability

Committed to environment Hydrocarbon gases (HC) in all product range.







Find out in detail how FagorKonnnect can specifically enhance the functionality of our refrigeration equipment.

This tool stands out for its ability to manage critical indoor temperatures, ensuring accurate and efficient control.



It will be possible to interact with the machine in order to carry out the necessary actions for this type of product, such as:

- Machine Configuration
- Turn on/off machine and light
- Launch defrost

Detail data relevant to the refrigeration equipment will be displayed. In this way, the status of this type of equipment can be correctly monitored:

- Compressor ON
- Temperatures (chamber, evaporator, condenser)
- Duration of defrosting.
- Condition of the doors.
- Activation of the fans.
- Active alarms

Specific graphs designed for the analysis of refrigeration equipment:

- States
- Alarms
- Compressor active hours
- Status of Doors





# Commercial refrigeration

Refrigerated uprights .....	251
Refrigerated counters .....	281
Preparation counters.....	311
Bast chillers .....	327
Bar line .....	339
Wine cellars & Meat agers.....	357
Ice makers.....	367





# Refrigerated uprights

- Features..... 255
- Advance GN 2/1 ..... 257
- Concept monoblock GN 2/1 ..... 261
- Concept GN 2/1 ..... 265
- Concept GN 2/1 dual temperature 271
- Concept GN 1/1 ..... 272
- Snack ..... 273
- Snack dual temperature ..... 275
- Pastry..... 278
- Fish..... 279
- Accessories ..... 280

Special units or any variations from the standard model must be assembled at the factory at an additional charge over the standard model's price.

Please, contact Fagor Professional for any other variation or option that is not included on this list.



The leader manufacturer of  
Commercial Refrigeration



Access the website



Sales brochure



# Efficient. Profitable. Sustainable.



**A**

**B**

**C**

**C**

**D**

**ADVANCE**

**CONCEPT MONOBLOCK**

**CONCEPT**

**SNACK CABINETS**

**PASTRY CABINETS**

**FISH CABINETS**

	AUP-11G	MUP-11G	CUP-11G	CUP-11S	CUP-11B	CUF-11
Capacity (N° of shelves per door)	24	23	23	18	20	7
Size of shelves	GN 2/1	GN 2/1	GN 2/1	560 x 542	600x400	600x400
Energy class	A	B	C	C	E	-
Insulation (mm)	80	60	60	50	50	50
Refrigerant + / -	R600a	R600a	R600a	R600a	R290	R290
Climate class (1 door)	5	4	4	4	4	4
Multiflow	Yes	Yes	No	No	No	No
HACCP compliant	Yes	No	No	No	No	No
Electronic control	Capacitive 5"	Capacitive 3"	Capacitive 3"	Capacitive 3"	Capacitive 3"	Capacitive 3"

Interface







# Characteristics

## Electronic control Easy to use

Functional and intuitive electronic control with capacitive keyboard that allows direct access to main functions.



## Embedded tray guides

The embedded tray guides facilitate cleaning in the cabinets. They also increase storage flexibility, allowing it to be adapted to the user's needs.



## Automatic closing door

Hinged doors with automatic return for a perfect closing that minimize temperature gain. Doors have a 120° dwell position and close automatically at less than 90°.



## ECO function

Function that optimizes the performance by automatically setting temperatures, when doors are not opened so that the cooling unit works only when needed and always, efficiently.



## Led lighting on the inside

The low energy consumption LED lights, strategically located on the sides, provide optimal illumination of the entire compartment.



## Pivotable panel

Pivotable panel with better access to control that facilitates service, thus enlarging the useful life of the equipment



## Climatic Class 5

Devices tested in harshest working environments, which ensure product preservation in high temperature and humidity conditions.

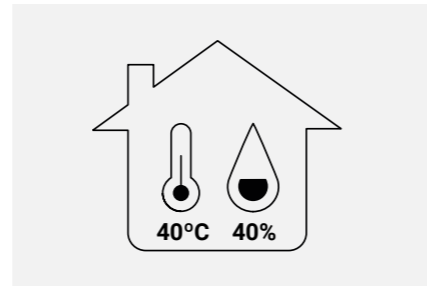

## Maximum stability

Height-adjustable stainless steel legs as standard. Height of the legs can be adjusted individually. In addition, there is also the option to choose swivel wheels or legs for marine.

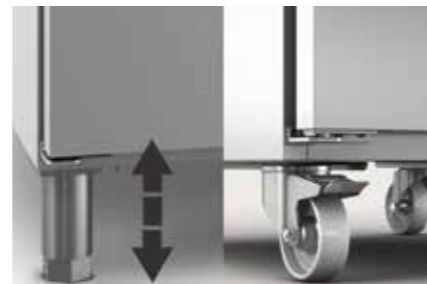

## Optimal refrigeration circuit

Internally designed forced draft cooling system with low consumption electronic components to guarantee optimal equipment efficiency and performance.



## Accesible door opening

Opening pedal as an option in all cabinets range, allowing to access the interior in a comfortable way.



## Connectivity

Guarantee the correct conservation of stored food through precise monitoring of your refrigeration equipment thanks to Fagor Konnect



## Multiflow

Optimal air circulation system that guarantees a balanced and constant distribution throughout the equipment, so that the temperature remains uniform. It helps preserve food for longer.



## Removable door gasket

Removable triple camera pull-out/push-in magnetic door gasket to keep maximum hygiene and maintain the insulating properties.

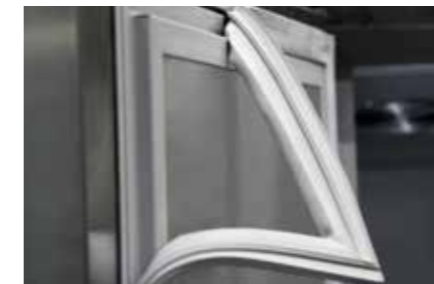

## Higher insulation thicknesses

Insulation thickness is a key factor in preventing losing cold. The new iKOLD generation increases the insulation levels of all mid ranges to provide greater cooling efficiency.



## Integrated handles

Stainless steel doors with ergonomic, full-length, robust, perfectly integrated handle. that ensures practical opening of the drawers and avoids dust and dirt collection.



Option available in the ADVANCE range (K Connectivity).



ADVANCE

## GN 2/1 700



## General characteristics

- Interior and exterior completely built with AISI-304 stainless steel.
- 80 mm thickness, CFC-free, high-density (40 kg/m<sup>3</sup>) polyurethane insulation, injected under high pressure.
- Embedded inner guides with 24 different level position 55 mm distance among them, enable more convenient cleaning operations without difficulties.
- Intuitive, large digital display for electronic control with energy saving function to ensure an optimal control of storing products.
- 10 HACCP alarms capacity which are store when high temperature variation and devices power failure.
- Height-adjustable stainless steel legs. Height of the legs can be adjusted individually (95 mm - 115 mm) to enable convenient cleaning.
- Stamped edge interiors, for easier cleaning operations to reduce potential dirt traps with a built-in drainage to get rid of waste liquid inside units.
- Removable and height adjustable epoxy coated GN 2/1 grids with a maximum loading capacity of up to 40 kg.
- Suitable for 1 x GN 2/1 GN 2 x GN 1/1 food containers.
- Electric connection 220V-240V 1N.

## Technical data

REFERENCE	MODEL	FREQUENCY	TEMPERATURE (°C)	GAS	COOLING POWER (kW)	ELECTRIC POWER (kW)	DEFROST	GROSS VOLUME (L)	ANNUAL CONSUMPTION (kWh)	ENERGY EFFICIENCY CLASS	DIMENSIONS	€
19089406	AUP-11G	50Hz	0°C +8 °C	R-600a	0,361 (1)	0,158	Stop	610	336 (4)	A	693 x 856 x 2106	-
19103143	AUPT-11G	50Hz	-2°C +8 °C	R-290	0,361 (1)	0,688	Electric	610	451 (4)	B	693 x 856 x 2106	-
19089398	AUN-11G	50Hz	-18°C -22°C	R-290	0,535 (2)	0,471	Hot gas (3)	610	2752 (4)	D	693 x 856 x 2106	-

(1) Evap. -10°C/ Cond. 45°C      (2) Evap. -25°C/ Cond. 45°C      (3) Remote Group Electric      (4) According to En22041 standard

## Options

		AUP-11G	AUPT-11G	AUN-11G
Connectivity	K	0	0	0
Opposite Opening	OP	0	0	0
G Type Plug	CI	0	0	0
Remote Group	RG	0	0	0
Castors	C	0	0	0
Back in Steel	BS	0	0	0
Frame Heater	FH	0	0	●
60Hz Version	60Hz	0	0	0
Door Pedal	PD	0	0	0

## Standard Accessories

	19097787	GN 2/1 EPOXY GRID	pc	3
---	----------	-------------------	----	---

ADVANCE

## GN 2/1 1400



## General characteristics

- Interior and exterior completely built with AISI-304 stainless steel.
- 80 mm thickness, CFC-free, high-density (40 kg/m<sup>3</sup>) polyurethane insulation, injected under high pressure.
- Embedded inner guides with 24 different level position 55 mm distance among them, enable more convenient cleaning operations without difficulties.
- Intuitive, large digital display for electronic control with energy saving function to ensure an optimal control of storing products.
- 10 HACCP alarms capacity which are store when high temperature variation and devices power failure.
- Height-adjustable stainless steel legs. Height of the legs can be adjusted individually (95 mm - 115 mm) to enable convenient cleaning.
- Stamped edge interiors, for easier cleaning operations to reduce potential dirt traps with a built-in drainage to get rid of waste liquid inside units.
- Removable and height adjustable epoxy coated GN 2/1 grids with a maximum loading capacity of up to 40 kg.
- Suitable for 1 x GN 2/1 or 2 x GN 1/1 food containers.
- Electric connection 220V-240V 1N.

## Technical data



REFERENCE	MODEL	FREQUENCY	TEMPERATURE (°C)	GAS	COOLING POWER (kW)	ELECTRIC POWER (kW)	DEFROST	GROSS VOLUME (L)	ANNUAL CONSUMPTION (kWh)	ENERGY EFFICIENCY CLASS	DIMENSIONS	€
19089396	AUP-22G	50Hz	0°C +8 °C	R-600a	0,436 (1)	0,192	Stop	1332	832 (4)	C	1358 x 856 x 2106	-
19103142	AUPT-22G	50Hz	-2°C +8 °C	R-600a	0,436 (1)	0,436	Electric	1332	944 (4)	C	1358 x 856 x 2106	-
19089420	AUN-22G	50Hz	-18°C -22°C	R-290	0,907 (2)	0,749	Hot gas (3)	1332	4599 (4)	D	1358 x 856 x 2106	-
19089422	AUN-22G CC5	50Hz	-18°C -22°C	R-290	0,907 (2)	0,825	Hot gas	1332	4234 (4)	D	1358 x 856 x 2106	-

(1) Evap. -10°C/ Cond. 45°C      (2) Evap. -25°C/ Cond. 45°C      (3) Remote Group Electric      (4) According to En22041 standard

## Options

		AUP-22G	AUPT-22G	AUN-22G	AUN-22G CC5
Connectivity	K	0	0	0	0
G Type Plug	CI	0	0	0	0
Remote Group	RG	0	0	0	-
Castors	C	0	0	0	0
Back in Steel	BS	0	0	0	0
Frame Heater	FH	0	0	●	●
60Hz Version	60Hz	0	0	0	0
Door Pedal	PD	0	0	0	0

## Standard Accessories

	19097787	GN 2/1 Epoxy coated grid	PC	6
	19014778	Tray support guides l=562mm	PC	3

ADVANCE

## GN 2/1 DISPLAY 700



## General characteristics

- Interior and exterior completely built with AISI-304 stainless steel.
- 80 mm thickness, CFC-free, high-density (40 kg/m<sup>3</sup>) polyurethane insulation, injected under high pressure.
- Embedded inner guides with 24 different level position 55 mm distance among them, enable more convenient cleaning operations without difficulties.
- Intuitive, large digital display for electronic control with energy saving function to ensure an optimal control of storing products.
- 10 HACCP alarms capacity which are store when high temperature variation and devices power failure.
- Glass door.
  - Refrigeration Double-glazed doors insulated with low thermal emissivity to reduce heat transfer in refrigeration.
  - Freezer and tropicalized uprights: Triple glazed door with electric heating system to avoid any kind of condensation in the doors.
- Height-adjustable stainless steel legs. Height of the legs can be adjusted individually (95 mm - 115 mm) to enable convenient cleaning.
- Stamped edge interiors, for easier cleaning operations to reduce potential dirt traps with a built-in drainage to get rid of waste liquid inside units.
- Suitable for 1 x GN 2/1 or 2 x GN 1/1 food containers.
- Electric connection 220V-240V 1N.

## Technical data

REFERENCE	MODEL	FRE-QUENCY	TEMPERATURE (°C)	GAS	COOLING POWER (kW)	ELECTRIC POWER (kW)	DEFROST	GROSS VOLUME (L)	ANNUAL CONSUMPTION (kWh)	ENERGY EFFICIENCY CLASS	DIMENSIONS	€
19089423	AUP-11G GD	50Hz	0°C +8 °C	R-600a	0,361 (1)	0,158	Stop	610	555 (5)	A	693 x 856 x 2106	-
19106080	AUPT-11G GD	50Hz	-2°C +8 °C	R-600a	0,361 (1)	0,768	Electric	610	1971 (5)	C	693 x 856 x 2106	-
19106024	AUN-11G GD	50Hz	-18°C -22°C	R-290	0,535 (2)	0,551	Hot gas (3)	610	5143 (5)	E	693 x 856 x 2106	-

(1) Evap. -10°C/ Cond. 45°C      (2) Evap. -25°C/ Cond. 45°C      (3) Remote Group Electric      (5) According to EN23953 standard

## Options

		AUP-22G GD	AUPT-22G GD	AUN-22G GD
Connectivity	K	0	0	0
Opposite Opening	OP	0	0	0
G Type Plug	CI	0	0	0
Remote Group	RG	0	0	0
Castors	C	0	0	0
Back in Steel	BS	0	0	0
Frame Heater	FH	0	0	●
60Hz Version	60Hz	0	0	0
Door Pedal	PD	0	0	0

259

## Standard Accessories

	19097787	GN 2/1 EPOXY GRID	pc	3
---	----------	-------------------	----	---

ADVANCE

## GN 2/1 DISPLAY 1400



## General characteristics

- Interior and exterior completely built with AISI-304 stainless steel.
- 80 mm thickness, CFC-free, high-density (40 kg/m<sup>3</sup>) polyurethane insulation, injected under high pressure.
- Embedded inner guides with 24 different level position 55 mm distance among them, enable more convenient cleaning operations without difficulties.
- Intuitive, large digital display for electronic control with energy saving function to ensure an optimal control of storing products.
- 10 HACCP alarms capacity which are store when high temperature variation and devices power failure
- Glass door.
  - Refrigeration Double-glazed doors insulated with low thermal emissivity to reduce heat transfer in refrigeration.
  - Freezer and tropicalized uprights: Triple glazed door with electric heating system to avoid any kind of condensation in the doors.
- Height-adjustable stainless steel legs. Height of the legs can be adjusted individually (95 mm - 115 mm) to enable convenient cleaning.
- Stamped edge interiors, for easier cleaning operations to reduce potential dirt traps with a built-in drainage to get rid of waste liquid inside units.
- Suitable for 1 x GN 2/1 or 2 x GN 1/1 food containers.
- Electric connection 220V-240V 1N

## Technical data



REFERENCE	MODEL	FRE-QUENCY	TEMPERATURE (°C)	GAS	COOLING POWER (kW)	ELECTRIC POWER (kW)	DEFROST	GROSS VOLUME (L)	ANNUAL CONSUMPTION (kWh)	ENERGY EFFICIENCY CLASS	DIMENSIONS	€
19089424	AUP-22G GD	50Hz	0°C +8 °C	R-600a	0,436 (1)	0,192	Stop	1332	1374 (5)	C	1358 x 856 x 2106	-
19106086	AUPT-22G GD	50Hz	-2°C +8 °C	R-600a	0,436 (1)	0,436	Electric	1332	3278 (5)	F	1358 x 856 x 2106	-
19106053	AUN-22G GD	50Hz	-18°C -22°C	R-290	0,907 (2)	0,907	Hot gas (3)	1332	9721 (5)	F	1358 x 856 x 2106	-

(1) Evap. -10°C/ Cond. 45°C      (2) Evap. -25°C/ Cond. 45°C      (3) Remote Group Electric      (5) According to EN23953 standard

## Options

		AUP-22G GD	AUPT-22G GD	AUN-22G GD
Connectivity	K	0	0	0
G Type Plug	CI	0	0	0
Remote Group	RG	0	0	0
Castors	C	0	0	0
Back in Steel	BS	0	0	0
Frame Heater	FH	0	0	●
60Hz Version	60Hz	0	0	0
Door Pedal	PD	0	0	0

## Standard Accessories

	19097787	GN 2/1 Epoxy coated grid	PC	6
	19014778	Tray support guides l=562mm	PC	3

260

## CONCEPT

## Monoblock GN 2/1 700



## General characteristics

- Interior constructed with AISI-304 stainless steel exterior in food grade stainless steel.
- 60 mm thickness, CFC-free, high-density (40 kg/m<sup>3</sup>) polyurethane insulation, injected under high pressure.
- Embedded inner guides with 23 different level position 55 mm distance among them, enable more convenient cleaning operations without difficulties.
- Intuitive, digital display for electronic control with energy saving function to ensure an optimal control of storing products.
- Internally designed monoblock cooling system. Top mounted evaporator ensure an easy maintenance of refrigeration unit, as well as an optimized use of storage compartment
- Height-adjustable stainless steel legs. Height of the legs can be adjusted individually (130 mm - 200 mm) to enable convenient cleaning.
- Removable and height adjustable epoxy coated GN 2/1 grids with a maximum loading capacity of up to 40 kg.
- Equipped with 3 GN 2/1 grid per each full door.
- Suitable for 1 x GN 2/1 or 2 x GN 1/1 food containers.
- Electric connection 220V-240V 1N

## Technical data

REFERENCE	MODEL	FRE-QUENCY	TEMPERATURE (°C)	GAS	COOLING POWER (kW)	ELECTRIC POWER (kW)	DEFROST	GROSS VOLUME (L)	ANNUAL CONSUMPTION (kWh)	ENERGY EFFICIENCY CLASS	DIMENSIONS	€
19089425	MUP-11G	50Hz	0°C +8 °C	R-600a	0,274 (1)	0,143	Stop	572	423 (4)	B	653 x 796 x 1996	-
19089426	MUP-12G	50Hz	0°C +8 °C	R-600a	0,274 (1)	0,143	Stop	572	423 (4)	B	653 x 796 x 1996	-
19089430	MUN-11G	50Hz	-18°C -22°C	R-290	0,364 (2)	0,328	Electric	572	2726 (4)	D	653 x 796 x 1996	-
19089432	MUN-12G	50Hz	-18°C -22°C	R-290	0,364 (2)	0,334	Electric	572	2726 (4)	D	653 x 796 x 1996	-

(1) Evap. -10°C/ Cond. 45°C

(2) Evap. -25°C/ Cond. 45°C

(4) According to En22041 standard

## Options

		MUP-11G	MUP-12G	MUN-11G	MUN-12G
Opposite Opening	OP	0	0	0	0
G Type Plug	CI	0	0	0	0
Lock	LC	0	-	0	-
Remote Group	RG	0	0	0	0
Castors	C	0	0	0	0
Back in Stainless Steel	BS	0	0	0	0
Frame heater	FH	0	0	●	●
60Hz	60Hz	0	0	0	0
Pedal	PD	0	-	0	-

## Standard Accessories

	19097787	GN 2/1 EPOXY GRID	pc	3
---	----------	-------------------	----	---

## CONCEPT

## Monoblock GN 2/1 1400



## General characteristics

- Interior constructed with AISI-304 stainless steel exterior in food grade stainless steel.
- 60 mm thickness, CFC-free, high-density (40 kg/m<sup>3</sup>) polyurethane insulation, injected under high pressure.
- Embedded inner guides with 23 different level position 55 mm distance among them, enable more convenient cleaning operations without difficulties.
- Intuitive, digital display for electronic control with energy saving function to ensure an optimal control of storing products.
- Internally designed monoblock cooling system. Top mounted evaporator ensure an easy maintenance of refrigeration unit, as well as an optimized use of storage compartment
- Height-adjustable stainless steel legs. Height of the legs can be adjusted individually (130 mm - 200 mm) to enable convenient cleaning.
- Stamped edge interiors, for easier cleaning operations to reduce potential dirt traps with a built-in drainage to get rid of waste liquid inside units.
- Removable and height adjustable epoxy coated GN 2/1 grids with a maximum loading capacity of up to 40 kg.
- Equipped with 3 GN 2/1 grid per each full door. and a set of grid support guides for middle beam.
- Suitable for 1 x GN 2/1 or 2 x GN 1/1 food containers.
- Electric connection 220V-240V 1N.

## Technical data

REFERENCE	MODEL	FRE-QUENCY	TEMPERATURE (°C)	GAS	COOLING POWER (kW)	ELECTRIC POWER (kW)	DEFROST	GROSS VOLUME (L)	ANNUAL CONSUMPTION (kWh)	ENERGY EFFICIENCY CLASS	DIMENSIONS	€
19089427	MUP-22G	50Hz	0°C +8 °C	R-600a	0,436 (1)	0,184	Stop	1144	756 (4)	C	1318 x 796 x 1996	-
19089428	MUP-23G	50Hz	0°C +8 °C	R-600a	0,436 (1)	0,184	Stop	1144	756 (4)	C	1318 x 796 x 1996	-
19089429	MUP-24G	50Hz	0°C +8 °C	R-600a	0,436 (1)	0,184	Stop	1144	756 (4)	C	1318 x 796 x 1996	-
19089434	MUN-22G	50Hz	-18°C -22°C	R-290	0,735 (2)	0,592	Electric	1144	4855 (4)	E	1318 x 796 x 1996	-
19089436	MUN-23G	50Hz	-18°C -22°C	R-290	0,735 (2)	0,598	Electric	1144	4855 (4)	E	1318 x 796 x 1996	-
19089438	MUN-24G	50Hz	-18°C -22°C	R-290	0,735 (2)	0,592	Electric	1144	4855 (4)	E	1318 x 796 x 1996	-

(1) Evap. -10°C/ Cond. 45°C



(2) Evap. -25°C/ Cond. 45°C

(4) According to En22041 standard

## Options

		MUP-22G	MUP-23G	MUP-24G	MUN-22G	MUN-23G	MUN-24G
G Type Plug	CI	0	0	0	0	0	0
Lock	LC	0	-	-	0	-	-
Remote Group	RG	0	0	0	0	0	0
Castors	C	0	0	0	0	0	0
Back in Stainless Steel	BS	0	0	0	0	0	0
Frame heater	FH	0	0	0	●	●	●
60Hz	60Hz	0	0	0	0	0	0
Pedal	PD	0	-	-	0	-	-

## Standard Accessories

	19097787	GN 2/1 Epoxy coated grid	PC	6
	19014778	Tray support guides l=562mm	PC	3



# Monoblock GN 2/1 Display



## General characteristics

- Interior constructed with AISI-304 stainless steel exterior in food grade stainless steel.
- 60 mm thickness, CFC-free, high-density (40 kg/m<sup>3</sup>) polyurethane insulation, injected under high pressure.
- Embedded inner guides with 23 different level position 55 mm distance among them, enable more convenient cleaning operations without difficulties.
- Intuitive, digital display for electronic control with energy saving function to ensure an optimal control of storing products.
- Double-glazed doors insulated with low thermal emissivity to reduce heat transfer with ergonomic handle.
- Internally designed monoblock cooling system. Top mounted evaporator ensure an easy maintenance of refrigeration unit, as well as an optimized use of storage compartment
- Height-adjustable stainless steel legs. Height of the legs can be adjusted individually (130 mm - 200 mm) to enable convenient cleaning.
- Stamped edge interiors, for easier cleaning operations to reduce potential dirt traps with a built-in drainage to get rid of waste liquid inside units.
- Removable and height adjustable epoxy coated GN 2/1 grids with a maximum loading capacity of up to 40 kg.
- Equipped with 3 GN 2/1 grid per each full door and a set of grid support guides for middle beam in double body uprights.
- Electric connection 220V-240V 1N

## Technical data

REFERENCE	MODEL	FRE- QUENCY	TEMPERATURE (°C)	GAS	COOLING POWER (kW)	ELECTRIC POWER (kW)	DEFROST	GROSS VOLUME (L)	ANNUAL CONSUMPTION (kWh)	ENERGY EFFICIENCY CLASS	DIMENSIONS	€
19089440	MUP-11G GD	50Hz	0°C +8 °C	R-600a	0,274 (1)	0,146	Stop	572	1971 (5)	C	653 x 796 x 1996	-
19089441	MUP-22G GD	50Hz	0°C +8 °C	R-600a	0,436 (1)	0,19	Stop	1144	3278 (5)	D	1318 x 796 x 1996	-

(1) Evap. -10°C/ Cond. 45°C (5) According to EN23953 standard

## Options

		MUP-11G GD	MUP-22G GD
Opposite Opening	OP	0	-
G Type Plug	CI	0	0
Lock	LC	●	●
Remote Group	RG	0	0
Castors	C	0	0
Back in Stainless Steel	BS	0	0
Frame heater	FH	0	0
60Hz	60Hz	0	0
Glass Door	GD	●	●
Pedal	PD	0	0

## Standard Accessories

				MUP- 11G	MUP- 22G
	19097787	GN 2/1 EPOXY GRID	pc	3	6
	19014778	TRAY SUPPORT GUIDES L=562mm	pc	0	3

# Monoblock GN 2/1 Dual Temperature



## General characteristics

- Interior constructed with AISI-304 stainless steel exterior in food grade stainless steel.
- 60 mm thickness, CFC-free, high-density (40 kg/m<sup>3</sup>) polyurethane insulation, injected under high pressure.
- Embedded inner guides with 23 different level position 55 mm distance among them, enable more convenient cleaning operations without difficulties.
- Intuitive, digital display for electronic control with energy saving function to ensure an optimal control of storing products.
- Internally designed monoblock cooling system. Top mounted evaporator ensure an easy maintenance of refrigeration unit, as well as an optimized use of storage compartment
- Height-adjustable stainless steel legs. Height of the legs can be adjusted individually (130 mm - 200 mm) to enable convenient cleaning.
- Stamped edge interiors, for easier cleaning operations to reduce potential dirt traps with a built-in drainage to get rid of waste liquid inside units.
- Removable and height adjustable epoxy coated GN 2/1 grids with a maximum loading capacity of up to 40 kg.
- Mixed refrigeration and freezer cabinet.
  - Refrigeration compartment working T<sup>a</sup>: 0 °C, +8 °C.
  - Freezer compartment working temperature: -18 °C, -22 °C.
- Electric connection 220V-240V 1N

## Technical data

REFERENCE	MODEL	FREQUENCY	COMPART- MENT	WORKING TEMPERATURE (°C)	GAS	COOLING POWER (kW)	DEFROST	GROSS VOLUME (L)	ELECTRIC POWER (kW)	DIMENSIONS	€
19089442	MUD-22G/M	50Hz	+	+0°C +8°C	R-600a	0,274 (1)	Stop	1144	0,471	1318 x 796 x 1996	-
			-	-18°C -22°C	R290	0,364 (2)	Electric				

(1) Evap. -10°C/ Cond. 45°C (2) Evap. -25°C/ Cond. 45°C

## Options

		MUD-22G/M
G Type Plug	CI	0
Lock	LC	0
Castors	C	0
Back in Stainless Steel	BS	0
Frame heater	FH	0
60Hz	60Hz	0
Pedal	PD	0

## Standard Accessories

	19097787	GN 2/1 Epoxy coated grid	PC	6	

## CONCEPT

## GN 2/1 700



## General characteristics

- Interior constructed with AISI-304 stainless steel exterior in food grade stainless steel.
- 60 mm thickness, CFC-free, high-density (40 kg/m<sup>3</sup>) polyurethane insulation, injected under high pressure.
- Embedded inner guides with 23 different level position 55 mm distance among them, enable more convenient cleaning operations without difficulties.
- Intuitive, digital display for electronic control with energy saving function to ensure an optimal control of storing products.
- Height-adjustable stainless steel legs. Height of the legs can be adjusted individually (130 mm - 200 mm) to enable convenient cleaning.
- Stamped edge interiors, for easier cleaning operations to reduce potential dirt traps with a built-in drainage to get rid of waste liquid inside units.
- Removable and height adjustable epoxy coated GN 2/1 grids with a maximum loading capacity of up to 40 kg.
- Suitable for 1 x GN 2/1 or 2 x GN 1/1 food containers.
- Electric connection 220V-240V 1N

## Technical data

REFERENCE	MODEL	FREQUENCY	TEMPERATURE (°C)	GAS	COOLING POWER (kW)	ELECTRIC POWER (kW)	DESESCARCHE	GROSS VOLUME (L)	ANNUAL CONSUMPTION (kWh)	ENERGY EFFICIENCY CLASS	DIMENSIONS	€
19089444	CUP-11G	50Hz	0°C +8 °C	R-600a	0,361 (1)	0,183	Stop	543	548 (4)	C	653 x 842 x 2040	-
19089446	CUP-12G	50Hz	0°C +8 °C	R-600a	0,361 (1)	0,183	Stop	543	548 (4)	C	653 x 842 x 2040	-
19103938	CUPT-11G	50Hz	-2°C +8 °C	R-600a	0,361 (1)	0,361	Electric	543	604 (4)	C	653 x 842 x 2040	-
19106019	CUPT-12G	50Hz	-2°C +8 °C	R-600a	0,361 (1)	0,361	Electric	543	604 (4)	C	653 x 842 x 2040	-
19089454	CUN-11G	50Hz	-18°C -22°C	R-290	0,535 (2)	0,471	Hot gas (3)	543	2714 (4)	D	653 x 842 x 2040	-
19089456	CUN-12G	50Hz	-18°C -22°C	R-290	0,535 (2)	0,477	Hot gas (3)	543	2714 (4)	D	653 x 842 x 2040	-

(1) Evap. -10°C/ Cond. 45°C

(2) Evap. -25°C/ Cond. 45°C

(3) Remote Group Electric

(4) According to En22041 standard

## Options

		CUP-11G	CUP-12G	CUPT-11G	CUPT-12G	CUN-11G	CUN-12G
Opposite Opening	OP	0	0	0	0	0	0
G Type Plug	CI	0	0	0	0	0	0
Lock	LC	0	-	0	-	0	-
Remote Group	RG	0	0	0	0	0	0
Castors	C	0	0	0	0	0	0
Back in Stainless	BS	0	0	0	0	0	0
Frame heater	FH	0	0	0	0	●	●
60Hz	60Hz	0	0	0	0	0	0
Pedal	PD	0	-	0	-	0	-

## Standard Accessories

		MUP-11G	MUP-22G
 19097787	GN 2/1 EPOXY GRID	pc	3
			6

## CONCEPT



## GN 2/1 1400



## General characteristics

- Interior constructed with AISI-304 stainless steel exterior in food grade stainless steel.
- 60 mm thickness, CFC-free, high-density (40 kg/m<sup>3</sup>) polyurethane insulation, injected under high pressure.
- Embedded inner guides with 23 different level position 55 mm distance among them, enable more convenient cleaning operations without difficulties.
- Intuitive, digital display for electronic control with energy saving function to ensure an optimal control of storing products.
- Height-adjustable stainless steel legs. Height of the legs can be adjusted individually (130 mm - 200 mm) to enable convenient cleaning.
- Stamped edge interiors, for easier cleaning operations to reduce potential dirt traps with a built-in drainage to get rid of waste liquid inside units.
- Removable and height adjustable epoxy coated GN 2/1 grids with a maximum loading capacity of up to 40 kg.
- Electric connection 220V-240V 1N

## Standard Accessories

	19097787	GN 2/1 Epoxy coated grid	PC	6
	19014778	Tray support guides l=562mm	PC	3

## Technical data

REFERENCE	MODEL	FREQUENCY	TEMPERATURE (°C)	GAS	COOLING POWER (kW)	ELECTRIC POWER (kW)	DESESCARCHE	GROSS VOLUME (L)	ANNUAL CONSUMPTION (kWh)	ENERGY EFFICIENCY CLASS	DIMENSIONS	€
19089448	CUP-22G	50Hz	0°C +8 °C	R-600a	0,436 (1)	0,206	Stop	1186	913 (4)	C	1318 x 842 x 2040	-
19089450	CUP-23G	50Hz	0°C +8 °C	R-600a	0,436 (1)	0,206	Stop	1186	913 (4)	C	1318 x 842 x 2040	-
19089452	CUP-24G	50Hz	0°C +8 °C	R-600a	0,436 (1)	0,206	Stop	1186	913 (4)	C	1318 x 842 x 2040	-
19103265	CUPT-22G	50Hz	-2°C +8 °C	R-290	0,436 (1)	0,436	Electric	1186	944 (4)	C	1318 x 842 x 2040	-
19106055	CUPT-23G	50Hz	-2°C +8 °C	R-290	0,436 (1)	0,436	Electric	1186	944 (4)	C	1318 x 842 x 2040	-
19106056	CUPT-24G	50Hz	-2°C +8 °C	R-600a	0,436 (1)	0,436	Electric	1186	944 (4)	C	1318 x 842 x 2040	-
19089458	CUN-22G	50Hz	-18°C -22°C	R-290	0,907 (2)	0,749	Hot gas (3)	1186	4793 (4)	E	1318 x 842 x 2040	-
19089460	CUN-23G	50Hz	-18°C -22°C	R-290	0,907 (2)	0,755	Hot gas (3)	1186	4793 (4)	E	1318 x 842 x 2040	-
19089462	CUN-24G	50Hz	-18°C -22°C	R-290	0,907 (2)	0,76	Hot gas (3)	1186	4793 (4)	E	1318 x 842 x 2040	-

(1) Evap. -10°C/ Cond. 45°C

(2) Evap. -25°C/ Cond. 45°C

(3) Remote Group Electric

(4) According to En22041 standard

## Options

		CUP-22G	CUP-23G	CUP-24G	CUPT-22G	CUPT-23G	CUPT-24G	CUN-22G	CUN-23G	CUN-24G
G Type Plug	CI	0	0	0	0	0	0	0	0	0
Lock	LC	0	-	-	0	-	0	-	-	-
Remote Group	RG	0	0	0	0	0	-	-	-	-
Castors	C	0	0	0	0	0	0	0	0	0
Back in Stainless Steel	BS	0	0	0	0	0	0	0	0	0
Frame heater	FH	0	0	0	0	0	●	●	●	●
60Hz	60Hz	0	0	0	0	0	0	0	0	0
Pedal	PD	0	-	-	0	-	0	-	-	-

## GN 2/1 Display 700



## General characteristics

- Interior constructed with AISI-304 stainless steel exterior in food grade stainless steel.
- 60 mm thickness, CFC-free, high-density (40 kg/m<sup>3</sup>) polyurethane insulation, injected under high pressure.
- Embedded inner guides with 23 different level position 55 mm distance among them, enable more convenient cleaning operations without difficulties.
- Intuitive, digital display for electronic control with energy saving function to ensure an optimal control of storing products.
- Glass door
  - Refrigeration Double-glazed doors insulated with low thermal emissivity to reduce heat transfer in refrigeration.
  - Freezer and tropicalized uprights: Triple glazed door with electric heating system to avoid any kind of condensation in the doors.
- Height-adjustable stainless steel legs. Height of the legs can be adjusted individually (130 mm - 200 mm) to enable convenient cleaning.
- Equipped with a door lock in full door models.
- Stamped edge interiors, for easier cleaning operations to reduce potential dirt traps with a built-in drainage to get rid of waste liquid inside units.
- Electric connection 220V-240V 1N

## Technical data

REFERENCE	MODEL	FRE-QUENCY	TEMPERATURE (°C)	GAS	COOLING POWER (kW)	ELECTRIC POWER (kW)	DEFROST	GROSS VOLUME (L)	ANNUAL CONSUMPTION (kWh)	ENERGY EFFICIENCY CLASS	DIMENSIONS	€
19089464	CUP-11G GD	50Hz	0°C +8 °C	R-600a	0,361 (1)	0,186	Stop	610	904 (5)	B	653 x 842 x 2040	-
19106095	CUPT-11G GD	50Hz	-2°C +8 °C	R-600a	0,361 (1)	0,361	Electric	1186	1981 (5)	C	1318 x 842 x 2040	-
19097604	CUN-11G GD	50Hz	-18°C -22°C	R-290	0,535 (2)	0,58	Hot gas (3)	543	5906 (5)	F	653 x 842 x 2040	-

(1) Evap. -10°C/ Cond. 45°C

(2) Evap. -25°C/ Cond. 45°C

(3) Remote Group Electric

(5) According to EN23953 standard

## Options

		CUP-11G GD	CUPT-11G GD	CUN-11G GD
Opposite Opening	OP	0	0	0
G Type Plug	CI	0	0	0
Lock	LC	●	●	●
Remote Group	RG	0	0	0
Castors	C	0	0	0
Back in Stainless Steel	BS	0	0	0
Frame heater	FH	0	0	●
60Hz	60Hz	0	0	0
Pedal	PD	0	0	0

## Standard Accessories

			MUP-11G	MUP-22G
	19097787	GN 2/1 EPOXY GRID	pc	3

## GN 2/1 Display 1400



## General characteristics

- Interior constructed with AISI-304 stainless steel exterior in food grade stainless steel.
- 60 mm thickness, CFC-free, high-density (40 kg/m<sup>3</sup>) polyurethane insulation, injected under high pressure.
- Embedded inner guides with 23 different level position 55 mm distance among them, enable more convenient cleaning operations without difficulties.
- Intuitive, digital display for electronic control with energy saving function to ensure an optimal control of storing products.
- Glass door
  - Refrigeration Double-glazed doors insulated with low thermal emissivity to reduce heat transfer in refrigeration.
  - Freezer and tropicalized uprights: Triple glazed door with electric heating system to avoid any kind of condensation in the doors.
- Height-adjustable stainless steel legs. Height of the legs can be adjusted individually (130 mm - 200 mm) to enable convenient cleaning.
- Equipped with a door lock in full door models.
- Stamped edge interiors, for easier cleaning operations to reduce potential dirt traps with a built-in drainage to get rid of waste liquid inside units.
- Electric connection 220V-240V 1N

## Technical data

REFERENCE	MODEL	FRE-QUENCY	TEMPERATURE (°C)	GAS	COOLING POWER (kW)	ELECTRIC POWER (kW)	DEFROST	GROSS VOLUME (L)	ANNUAL CONSUMPTION (kWh)	ENERGY EFFICIENCY CLASS	DIMENSIONS	€
19089468	CUP-22G GD	50Hz	0°C +8 °C	R-600a	0,436 (1)	0,212	Stop	1332	1369 (5)	B	1318 x 842 x 2040	-
19106098	CUPT-22G GD	50Hz	-2°C +8 °C	R-600a	0,436 (1)	0,896	Electric	543	3321 (5)	D	653 x 842 x 2040	-
19099968	CUN-22G GD	50Hz	-18°C -22°C	R-290	0,907 (2)	0,749	Hot gas (3)	1186	9721 (5)	F	1318 x 842 x 2040	-

(1) Evap. -10°C/ Cond. 45°C

(2) Evap. -25°C/ Cond. 45°C



(3) Remote Group Electric

(5) According to EN23953 standard

## Options

		CUP-22G GD	CUPT-22G GD	CUN-22G
G Type Plug	CI	0	0	0
Lock	LC	●	●	●
Remote Group	RG	0	0	0
Castors	C	0	0	0
Back in Stainless Steel	BS	0	0	0
Frame heater	FH	0	0	●
60Hz	60Hz	0	0	0
Pedal	PD	0	0	0

## Standard Accessories

	19097787	GN 2/1 Epoxy coated grid	PC	6
	19014778	Tray support guides l=562mm	PC	3

# GN 2/1 700 with Freezing Compartment



## General characteristics

- Interior constructed with AISI-304 stainless steel exterior in food grade stainless steel.
- Intuitive, digital display for electronic control with energy saving function to ensure an optimal control of storing products.
- Hinged doors with automatic return for a perfect closing that minimize temperature gain. Doors have a 120° dwell position and close.
- Height-adjustable stainless steel legs. Height of the legs can be adjusted individually (130 mm - 200 mm) to enable convenient cleaning.
- CUD-22G/M
  - 60 mm insulation, embedded and inner guides independent modules with their respective refrigeration units and electronic controls.
  - Equipped with removable and height adjustable epoxy coated 3 x GN 2/1 grids with a maximum loading capacity of up to 40 kg.
- CUD-XXG/N
  - 50 mm insulation, with zipper and Removable guiding rails system
  - Refrigeration compartment equipped with GN 2/1 guides
  - Freezer compartment equipped with 3 PVC 530X540 sanitary baskets
- Electric connection 220V-240V 1N

## Technical data

REFERENCE	MODEL	FREQUENCY	COMPARTMENT	TEMPERATURE (°C)	GAS	COOLING POWER (kW)	DEFROST	GROSS VOLUME (L)	ELECTRIC POWER (kW)	DIMENSIONS	€
19089470	CUD-22G/M	50Hz	+	0°C +8 °C	R-600a	0,361 (1)	Stop	1220	0,654	1318 x 842 x 2040	-
			-	-18°C -22°C	R290	0,535 (2)	Electric				
19089472	CUD-12G/N	50Hz	+	0°C +8 °C	R-290	0,369 (1)	Stop	596	0,741	693 x 826 x 2008	-
			-	-18°C -22°C	R290	0,364 (2)	Electric				
19089474	CUD-23G/N	50Hz	+	0°C +8 °C	R-600a	0,436 (1)	Stop	1301	0,658	1388 x 826 x 2008	-
			-	-18°C -22°C	R290	0,364 (2)	Electric				
19089476	CUD-24G/N	50Hz	+	0°C +8 °C	R-600a	0,436 (1)	Stop	1301	0,658	1388 x 826 x 2008	-
			-	-18°C -22°C	R290	0,364 (2)	Electric				

(1) Evap. -10°C/ Cond. 45°C (2) Evap. -25°C/ Cond. 45°C

## Options

		CUD-22G/M	CUD-12G/N	CUD-23G/N	CUD-24G/N
Opposite Opening	OP	-	0	-	-
G Type Plug	CI	0	0	0	0
Castors	C	0	0	0	0
Back in Stainless Steel	BS	0	0	0	0
Frame heater	FH	0	0	0	0
60Hz	60Hz	0	0	0	0
Pedal	PD	0	-	-	-

## Standard Accessories

			CUD-12G/N	CUD-23G/N	CUD-24G/N
	19097787	GN 2/1 EPOXY GRID	pc	3	6
	19010206	TRAY SUPPORT GUIDES L=662 mm	pc	0	4 7 7
	19097770	530x540x100 PLASTIC TRAY	pc	0	3 3 3

# GN 2/1 1400 with Fish Compartment



## General characteristics

- Interior constructed with AISI-304 stainless steel exterior in food grade stainless steel.
- 50 mm thickness, CFC-free, high-density (40 kg/m³) polyurethane insulation, injected under high pressure.
- Removable guiding rails construction with 18 grid level position per each full doorwith 70 mm distance among them.
- Intuitive, digital display for electronic control with energy saving function to ensure an optimal control of storing products.
- Height-adjustable stainless steel legs. Height of the legs can be adjusted individually (130 mm - 200 mm) to enable convenient cleaning.
- Stamped edge interiors, for easier cleaning operations to reduce potential dirt traps with a built-in drainage to get rid of waste liquid inside units.
- Refrigeration compartment
  - Removable guiding rails construction with 18 grid level position per each full doorwith 70 mm distance among them.
  - Height adjustable epoxy coated GN 2/1 grids with a maximum loading capacity of up to 40 kg.
- Fish compartment
  - Equipped with 3 sanitary PVC baskets 530x540
  - Electric connection 220V-240V 1N

## Technical data

REFERENCE	MODEL	FREQUENCY	COMPARTMENT	TEMPERATURE (°C)	GAS	COOLING POWER (kW)	DEFROST	GROSS VOLUME (L)	ELECTRIC POWER (kW)	DIMENSIONS	€
19089478	CUD-12G/F	50Hz	+	0°C +8 °C	R-290	0,369 (1)	Stop	596	0,954	693 x 826 x 2008	-
			F	-4°C -2°C	R290	0,25 (1)	Electric				
19089479	CUD-23G/F	50Hz	+	0°C +8 °C	R-600a	0,436 (1)	Stop	1301	0,852	1388 x 826 x 2008	-
			F	-4°C -2°C	R290	0,25 (1)	Electric				
19089480	CUD-24G/F	50Hz	+	0°C +8 °C	R-600a	0,436 (1)	Stop	1301	0,852	1388 x 826 x 2008	-
			F	-4°C -2°C	R290	0,25 (1)	Electric				

(1) Evap. -10°C/ Cond. 45°C (2) Evap. -25°C/ Cond. 45°C

## Options

			CUD-12G/F	CUD-23G/F	CUD-24G/F
Opposite Opening	OP		0	-	-
G Type Plug	CI		0	0	0
Castors	C		0	0	0
Back in Stainless Steel	BS		0	0	0
Frame heater	FH		0	0	0
60Hz	60Hz		0	0	0

## Standard Accessories

				CUD-12G/F	CUD-23G/F	CUD-24G/F
	19097787	GN 2/1 Epoxy coated grid	PC	1	4	4
	19014778	Tray support guides l=562mm	PC	2	4	4
	19097759	530x460x100 PLASTIC TRAY	PC	3	3	3
	19097774	SS PERFORATED BOTTOM		3	3	3
	19097781	TRAY SUPPORT GUIDES L=613mm		3	3	3



CONCEPT

# GN 2/1 Dual Temperature



### General characteristics

- Interior constructed with AISI-304 stainless steel exterior in food grade stainless steel.
- 50 mm thickness, CFC-free, high-density (40 kg/m³) polyurethane insulation, injected under high pressure.
- Removable guiding rails construction with 18 grid level position per each full door with 70 mm distance among them.
- Intuitive, digital display for electronic control with energy saving function to ensure an optimal control of storing products.
- Internally designed monoblock cooling system. Top mounted evaporator ensure an easy maintenance of refrigeration unit, as well as an optimized use of storage compartment
- Height-adjustable stainless steel legs. Height of the legs can be adjusted individually (130 mm - 200 mm) to enable convenient cleaning.
- Stamped edge interiors, for easier cleaning operations to reduce potential dirt traps with a built-in drainage to get rid of waste liquid inside units.
- Removable and height adjustable epoxy coated GN 2/1 grids with a maximum loading capacity of up to 40 kg.
- Suitable for 1 x GN2/1 or 2 x GN1/1 food containers.
- Electric connection 220V-240V 1N

### Technical data

REFERENCE	MODEL	FRE-QUENCY	COMPART-MENT	TEMPERATURE (°C)	GAS	COOLING POWER (kW)	DEFROST	GROSS VOLUME (L)	ANNUAL CONSUMPTION (kWh)	ENERGY EFFICIENCY CLASS	ELECTRIC POWER (kW)	DIMENSIONS	€
19089481	CUD-12G/2	50Hz	+1	0°C +8 °C	R-290	0,369 (1)	Stop	596	679 (4)	D	0,616	693 x 826 x 2008	-
			+2	0°C +8 °C	R-290	0,25 (1)	Electric						
19089482	CUD-22G/2	50Hz	+1	0°C +8 °C	R-600a	0,361 (1)	Stop	1301	905 (4)	D	0,367	1388 x 826 x 2008	-
			+2	0°C +8 °C	R-600a	0,361 (1)	Electric						
19089483	CUD-23G/2	50Hz	+1	0°C +8 °C	R-600a	0,361 (1)	Stop	1301	905 (4)	D	0,367	1388 x 826 x 2008	-
			+2	0°C +8 °C	R-600a	0,361 (1)	Electric						
19089484	CUD-24G/2	50Hz	+1	0°C +8 °C	R-600a	0,361 (1)	Stop	1301	905 (4)	D	0,367	1388 x 826 x 2008	-
			+2	0°C +8 °C	R-600a	0,361 (1)	Electric						

(1) Evap. -10°C/ Cond. 45°C      (2) Evap. -25°C/ Cond. 45°C      (4) According to En22041 standard

### Options

		CUD-12G/2	CUD-22G/2	CUD-23G/2	CUD-24G/2
G Type Plug	CI	0	0	0	0
Lock	LC	-	0	-	-
Castors	C	0	0	0	0
Back in Stainless Steel	BS	0	0	0	0
Frame heater	FH	0	0	0	0
60Hz	60Hz	0	0	0	0
Pedal	PD	-	0	-	-

### Standard Accessories

			CUD-12G/2	CUD-22G/2	CUD-23G/2	CUD-24G/2
	19097787	GN 2/1 EPOXY GRID	pc	2	6	6
	19010206	TRAY SUPPORT GUIDES L=662 mm	pc	2	6	6

CONCEPT

# GN 1/1 400



### General characteristics

- Interior constructed with AISI-304 stainless steel exterior in food grade stainless steel.
- 60 mm thickness, CFC-free, high-density (40 kg/m³) polyurethane insulation, injected under high pressure.
- Removable guiding rails construction with 18 grid level position per each full door with 70 mm distance among them.
- Intuitive, digital display for electronic control with energy saving function to ensure an optimal control of storing products.
- Height-adjustable stainless steel legs. Height of the legs can be adjusted individually (130 mm - 200 mm) to enable convenient cleaning.
- Stamped edge interiors, for easier cleaning operations to reduce potential dirt traps with a built-in drainage to get rid of waste liquid inside units.
- Removable and height adjustable epoxy coated GN 1/1 grids with a maximum loading capacity of up to 40 kg.
- Electric connection 220V-240V 1N

### Technical data

REFERENCE	MODEL	FRE-QUENCY	TEMPERATURE (°C)	GAS	COOLING POWER (kW)	ELECTRIC POWER (kW)	DEFROST	GROSS VOLUME (L)	ANNUAL CONSUMPTION (kWh)	ENERGY EFFICIENCY CLASS	DIMENSIONS	€
19089485	CUP-11G1/1	50Hz	0°C +8 °C	R-600a	0,361 (1)	0,205	Stop	305	726 (4)	D	490 x 700 x 2010	-
19089487	CUP-11G1/1 GD	50Hz	0°C +8 °C	R-600a	0,361 (1)	0,208	Stop	305	1198 (5)	C	490 x 700 x 2010	-
19089489	CUN-11G1/1	50Hz	-18°C -22°C	R-290	0,364 (2)	0,369	Electric	305	2197 (4)	E	490 x 700 x 2010	-

(1) Evap. -10°C/ Cond. 45°C      (2) Evap. -25°C/ Cond. 45°C      (4) According to En22041 standard      (5) According to EN23953 standard

### Options

		CUP-11G1/1	CUP-11G1/1 GD	CUN-11G1/1
Opposite Opening	OP	0	0	0
G Type Plug	CI	0	0	0
Lock	LC	0	●	0
Remote Group	RG	0	0	0
Castors	C	0	0	0
Back in Stainless Steel	BS	0	0	0
Frame heater	FH	0	0	●
60Hz	60Hz	0	0	0
Glass Door	GD	-	●	-
Pedal	PD	0	0	0

### Standard Accessories

	19097778	GN 1/1 Epoxy coated grid 530x325	3
	19100845	TRAY SUPPORT GUIDES L=532 mm	3

# Snack 600



## General characteristics

- Interior and exterior built-in with food grade stainless steel for intensive professional applications.
- 50 mm thickness, CFC-free, high-density (40 kg/m³) polyurethane insulation, injected under high pressure.
- Constructed with a rail system placed in the front and back of the upright with 18 grid level position and 70mm distance among them.
- Intuitive, digital display for electronic control with energy saving function to ensure an optimal control of storing products.
- Height-adjustable stainless steel legs. Height of the legs can be adjusted individually (130 mm - 200 mm) to enable convenient cleaning.
- Removable and height adjustable epoxy coated 560x542 size grids with a maximum loading capacity of up to 40 kg.
- Electric connection 220V-240V 1N

## Technical data

REFERENCE	MODEL	FRE-QUENCY	TEMPERATURE (°C)	GAS	COOLING POWER (kW)	ELECTRIC POWER (kW)	DEFROST	GROSS VOLUME (L)	ANNUAL CONSUMPTION (kWh)	ENERGY EFFICIENCY CLASS	DIMENSIONS	€
19089491	CUP-11S	50Hz	0°C +8 °C	R-600a	0,361 (1)	0,183	Stop	506	548 (4)	C	693 x 726 x 2067	-
19089493	CUP-12S	50Hz	0°C +8 °C	R-600a	0,361 (1)	0,183	Stop	506	548 (4)	C	693 x 726 x 2067	-
19089505	CUN-11S	50Hz	-18°C -22°C	R-290	0,364 (2)	0,35	Electric	506	2179 (4)	D	693 x 726 x 2067	-
19089507	CUN-12S	50Hz	-18°C -22°C	R-290	0,364 (2)	0,356	Electric	506	2179 (4)	D	693 x 726 x 2067	-

(1) Evap. -10°C/ Cond. 45°C

(2) Evap. -25°C/ Cond. 45°C

(4) According to En22041 standard

## Options

		CUP-11S	CUP-12S	CUN-11S	CUN-12S
Opposite Opening	OP	0	0	0	0
G Type Plug	CI	0	0	0	0
Lock	LC	0	-	0	-
Remote Group	RG	0	0	0	0
Castors	C	0	0	0	0
Back in Stainless Steel	BS	0	0	0	0
Frame heater	FH	0	0	●	●
60Hz	60Hz	0	0	0	0
Pedal	PD	0	-	0	-

## Standard Accessories

	19097772	560x542 EPOXY GRID	pc	3
--	----------	--------------------	----	---

# Snack 1200



## General characteristics

- Interior and exterior built-in with food grade stainless steel for intensive professional applications.
- 50 mm thickness, CFC-free, high-density (40 kg/m³) polyurethane insulation, injected under high pressure.
- Constructed with a rail system placed in the front and back of the upright with 18 grid level position and 70mm distance among them.
- Intuitive, digital display for electronic control with energy saving function to ensure an optimal control of storing products.
- Height-adjustable stainless steel legs. Height of the legs can be adjusted individually (130 mm - 200 mm) to enable convenient cleaning.
- Stamped edge interiors, for easier cleaning operations to reduce potential dirt traps with a built-in drainage to get rid of waste liquid inside units.
- Removable and height adjustable epoxy coated 560x542 size grids with a maximum loading capacity of up to 40 kg.
- Electric connection 220V-240V 1N

## Technical data

REFERENCE	MODEL	FRE-QUENCY	TEMPERATURE (°C)	GAS	COOLING POWER (kW)	ELECTRIC POWER (kW)	DEFROST	GROSS VOLUME (L)	ANNUAL CONSUMPTION (kWh)	ENERGY EFFICIENCY CLASS	DIMENSIONS	€
19089495	CUP-22S	50Hz	0°C +8 °C	R-600a	0,436 (1)	0,206	Stop	1109	975 (4)	C	1388 x 726 x 2067	-
19089497	CUP-23S	50Hz	0°C +8 °C	R-600a	0,436 (1)	0,206	Stop	1109	975 (4)	C	1388 x 726 x 2067	-
19089499	CUP-24S	50Hz	0°C +8 °C	R-600a	0,436 (1)	0,206	Stop	1109	975 (4)	C	1388 x 726 x 2067	-
19089509	CUN-22S	50Hz	-18°C -22°C	R-290	0,735 (2)	0,601	Electric	1109	4855 (4)	E	1388 x 726 x 2067	-
19089511	CUN-23S	50Hz	-18°C -22°C	R-290	0,735 (2)	0,607	Electric	1109	4855 (4)	E	1388 x 726 x 2067	-
19089513	CUN-24S	50Hz	-18°C -22°C	R-290	0,735 (2)	0,613	Electric	1109	4855 (4)	E	1388 x 726 x 2067	-

(1) Evap. -10°C/ Cond. 45°C

(2) Evap. -25°C/ Cond. 45°C

(4) According to En22041 standard

## Options

		CUP-22S	CUP-23S	CUP-24S	CUN-22S	CUN-23S	CUN-24S
G Type Plug	CI	0	0	0	0	0	0
Lock	LC	0	-	-	0	-	-
Remote Group	RG	0	0	0	0	0	0
Castors	C	0	0	0	0	0	0
Back in Stainless Steel	BS	0	0	0	0	0	0
Frame heater	FH	0	0	0	●	●	●
60Hz	60Hz	0	0	0	0	0	0
Pedal	PD	0	-	-	0	-	-

## Standard Accessories

	19097772	560x542 EPOXY GRID	pc	6
	19097785	500x154 EPOXY GRID	pc	3

# Snack Display



## General characteristics

- Interior and exterior built-in with food grade stainless steel for intensive professional applications.
- 50 mm thickness, CFC-free, high-density (40 kg/m<sup>3</sup>) polyurethane insulation, injected under high pressure.
- Constructed with a rail system placed in the front and back of the upright with 18 grid level position and 70mm distance among them.
- Intuitive, digital display for electronic control with energy saving function to ensure an optimal control of storing products.
- Double-glazed doors insulated with low thermal emissivity to reduce heat transfer in refrigeration.
- Height-adjustable stainless steel legs. Height of the legs can be adjusted individually (130 mm - 200 mm) to enable convenient cleaning.
- Stamped edge interiors, for easier cleaning operations to reduce potential dirt traps with a built-in drainage to get rid of waste liquid inside units.
- Removable and height adjustable epoxy coated 560x542 size grids with a maximum loading capacity of up to 40 kg.
- Electric connection 220V-240V 1N.

## Technical data

REFERENCE	MODEL	FREQUENCY	TEMPERATURE (°C)	GAS	COOLING POWER (kW)	ELECTRIC POWER (kW)	DEFROST	GROSS VOLUME (L)	ANNUAL CONSUMPTION (kWh)	ENERGY EFFICIENCY CLASS	DIMENSIONS	€
19089501	CUP-11S GD	50Hz	0°C +8 °C	R-600a	0,361 (1)	0,186	Stop	506	904 (5)	B	693 x 726 x 2067	-
19089503	CUP-22S GD	50Hz	0°C +8 °C	R-600a	0,436 (1)	0,212	Stop	1109	1609 (5)	B	1388 x 726 x 2067	-

(1) Evap. -10°C/ Cond. 45°C (2) Evap. -25°C/ Cond. 45°C

## Options

		CUP-11S GD	CUP-22S GD
G Type Plug	CI	0	0
Lock	LC	●	●
Remote Group	RG	0	0
Castors	C	0	0
Back in Stainless Steel	BS	0	0
Frame heater	FH	0	0
60Hz	60Hz	0	0
Pedal	PD	0	0

## Standard Accessories

			CUP-11S	CUP-22S
19097772	560x542 EPOXY GRID	pc	3	6
19097785	500x154 EPOXY GRID	pc	0	3

# Snack with Freezing Compartment



## General characteristics

- Interior and exterior built-in with food grade stainless steel for intensive professional applications.
- 50 mm thickness, CFC-free, high-density (40 kg/m<sup>3</sup>) polyurethane insulation, injected under high pressure.
- Constructed with a rail system placed in the front and back of the upright with 18 grid level position and 70mm distance among them.
- Intuitive, digital display for electronic control with energy saving function to ensure an optimal control of storing products.
- Height-adjustable stainless steel legs. Height of the legs can be adjusted individually (130 mm - 200 mm) to enable convenient cleaning.
- CUD-22S/M
  - Equipped with 3 560x542 grid per each full door with a maximum loading capacity of up to 40 kg.
- CUD-XXS/N
  - Refrigeration chamber equipped with 3 560x542 grid per full door compartment and 1 piece in half door compartment
  - freezer compartment equipped with 3 PVC 530x540 sanitary baskets
- Electric connection 220V-240V 1N

## Technical data

REFERENCE	MODEL	FREQUENCY	COMPARTMENT COLUMEN	TEMPERATURE (°C)	GAS	COOLING POWER (kW)	DEFROST	GROSS VOLUME (L)	ELECTRIC POWER (kW)	DIMENSIONS	€
19089515	CUD-22S/M	50Hz	+	0°C +8 °C	R-600a	0,361 (1)	Stop	1012	0,533	1388 x 726 x 2067	-
			-	-18°C -22°C	R290	0,364 (2)	Electric				
19089517	CUD-12S/N	50Hz	+	0°C +8 °C	R-290	0,369 (1)	Stop	506	0,581	693 x 726 x 2067	-
			-	-18°C -22°C	R290	0,364 (2)	Electric				
19089519	CUD-23S/N	50Hz	+	0°C +8 °C	R-600a	0,436 (1)	Stop	1109	0,578	1388 x 726 x 2067	-
			-	-18°C -22°C	R290	0,364 (2)	Electric				
19089521	CUD-24S/N	50Hz	+	0°C +8 °C	R-600a	0,436 (1)	Stop	1109	0,578	1388 x 726 x 2067	-
			-	-18°C -22°C	R290	0,364 (2)	Electric				

(1) Evap. -10°C/ Cond. 45°C (2) Evap. -25°C/ Cond. 45°C

## Options

		CUD-22S/M	CUD-12S/N	CUD-23S/N	CUD-24S/N
G Type Plug	CI	0	0	0	0
Lock	LC	0	-	-	-
Castors	C	0	0	0	0
Back in Stainless Steel	BS	0	0	0	0
Frame heater	FH	0	0	0	0
60Hz	60Hz	0	0	0	0
Pedal	PD	0	-	-	-

## Standard Accessories

			CUD-22S/M	CUD-12S/N	CUD-23S/N	CUD-24S/N
19097772	560x542 EPOXY GRID	pc	6	1	4	4
19097785	500x154 EPOXY GRID	pc	0	0	1	1
19097784	TRAY SUPPORT GUIDES L=562mm	pc	0	3	3	3
19097770	530x540x100 PLASTIC TRAY	pc	0	3	3	3

## Snack with Fish Compartment



### General characteristics

- Interior and exterior built-in with food grade stainless steel for intensive professional applications.
- 50 mm thickness, CFC-free, high-density (40 kg/m<sup>3</sup>) polyurethane insulation, injected under high pressure.
- Constructed with a rail system placed in the front and back of the upright with 18 grid level position and 70mm distance among them.
- Intuitive, digital display for electronic control with energy saving function to ensure an optimal control of storing products.
- Height-adjustable stainless steel legs. Height of the legs can be adjusted individually (130 mm - 200 mm) to enable convenient cleaning.
- Refrigeration chamber equipped with 3 560x542 grid per each full door and 1 per each half door.
- Fish compartment equipped with 3 PVC 530X540 sanitary baskets
- Electric connection 220V-240V 1N

### Technical data

REFERENCE	MODEL	FREQUENCY	COMPARTMENT	TEMPERATURE (°C)	GAS	COOLING POWER (kW)	DEFROST	GROSS VOLUME (L)	ELECTRIC POWER (kW)	DIMENSIONS	€
19089523	CUD-12S/F	50Hz	+	0°C +8 °C	R-290	0,369 (1)	Stop	506	0,874	693 x 726 x 2067	-
			F	-4°C -2°C	R290	0,25 (1)	Electric				
19089524	CUD-23S/F	50Hz	+	0°C +8 °C	R-600a	0,436 (1)	Stop	1109	0,852	1388 x 726 x 2067	-
			F	-4°C -2°C	R290	0,25 (1)	Electric				
19089525	CUD-24S/F	50Hz	+	0°C +8 °C	R-600a	0,436 (1)	Stop	1109	0,852	1388 x 726 x 2067	-
			F	-4°C -2°C	R290	0,25 (1)	Electric				

(1) Evap. -10°C/ Cond. 45°C (2) Evap. -25°C/ Cond. 45°C

### Options

		CUD-12S/F	CUD-23S/F	CUD-24S/F
Opposite Opening	OP	0	-	-
G Type Plug	CI	0	0	0
Castors	C	0	0	0
Back in Stainless Steel	BS	0	0	0
Frame heater	FH	0	0	0
60Hz	60Hz	0	0	0

### Standard Accessories

			CUD-12S/F	CUD-23S/F	CUD-24S/F	
	19097772	560x542 EPOXY GRID	pc	1	4	4
	19097785	500x154 EPOXY GRID	pc	0	1	1
	19097759	530x460x100 PLASTIC TRAY	pc	3	3	3
	19097773	SS PERFORATED BOTTOM	pc	3	3	3
	19015961	TRAY SUPPORT GUIDES L=519mm	pc	3	3	3

## Pastry EN60x40



### General characteristics

- Interior and exterior built-in with food grade stainless steel for intensive professional applications.
- 50 mm thickness, CFC-free, high-density (40 kg/m<sup>3</sup>) polyurethane insulation, injected under high pressure.
- Constructed with a rail system placed in the front and back of the upright with 20 grid level position and 60mm distance among them.
- Intuitive, digital display for electronic control with energy saving function to ensure an optimal control of storing products.
- Height-adjustable stainless steel legs. Height of the legs can be adjusted individually (130 mm - 200 mm) to enable convenient cleaning.
- Stamped edge interiors, for easier cleaning operations to reduce potential dirt traps with a built-in drainage to get rid of waste liquid inside units.
- Removable and height adjustable epoxy coated EN60x40 size grids with a maximum loading capacity of up to 40 kg.
- Electric connection 220V-240V 1N

### Technical data

REFERENCE	MODEL	FREQUENCY	TEMPERATURE (°C)	GAS	COOLING POWER (kW)	ELECTRIC POWER (kW)	DEFROST	GROSS VOLUME (L)	CONSUMPTION (kWh)	ENERGY EFFICIENCY CLASS	DIMENSIONS	€
19089526	CUP-11B	50Hz	0°C +8 °C	R-290	0,369 (1)	0,251	Stop	574	927 (4)	E	760 x 729 x 2006	-
19106057	CUN-11B	50Hz	-18°C -22°C	R-290	0,364 (2)	0,348	Electric	574	2978 (4)	E	760 x 729 x 2006	-

(1) Evap. -10°C/ Cond. 45°C (2) Evap. -25°C/ Cond. 45°C (4) According to EN22041 standard

### Options

		CUP-11B	CUN-11B
Opposite Opening	OP	0	0
G Type Plug	CI	0	0
Lock	LC	0	0
Remote Group	RG	0	0
Castors	C	0	0
Back in Stainless Steel	BS	0	0
Frame heater	FH	0	●
60Hz	60Hz	0	0
Pedal	PD	0	0

### Standard Accessories

	19097772	560x542 EPOXY GRID	pc	3
	19033558	TRAY SUPPORT GUIDES L=496mm	pc	3



# Fish EN60x40



## General characteristics

- Interior and exterior built-in with food grade stainless steel for intensive professional applications.
- 50 mm thickness, CFC-free, high-density (40 kg/m<sup>3</sup>) polyurethane insulation, injected under high pressure.
- Constructed with a rail system placed in the front and back of the upright with 20 grid level position and 60mm distance among them.
- Intuitive, digital display for electronic control with energy saving function to ensure an optimal control of storing products.
- Height-adjustable stainless steel legs. Height of the legs can be adjusted individually (130 mm - 200 mm) to enable convenient cleaning.
- Stamped edge interiors, for easier cleaning operations to reduce potential dirt traps with a built-in drainage to get rid of waste liquid inside units.
- Removable and height adjustable 600x400x120 baskets with a maximum loading capacity of up to 40Kg.
- Equipped with 7 600x400x120 PVC baskets with a stainless steel manufactured perforated bottom and 7 sets of guiding support.
- Electric connection 220V-240V 1N

## Technical data

REFERENCE	MODEL	FRE-QUENCY	TEMPERATURE (°C)	GAS	COOLING POWER (kW)	ELECTRIC POWER (kW)	DEFROST	GROSS VOLUME (L)	DIMENSIONS	€
19089527	CU-11F	50Hz	-4°C -2 °C	R-290	0,369 (1)	0,268	ELECTRIC	574	760 x 729 x 2006	-



(1) Evap. -10°C/ Cond. 45°C

(2) Evap. -25°C/ Cond. 45°C







## Options

		CU-11F
Opposite Opening	OP	0
G Type Plug	CI	0
Lock	LC	0
Remote Group	RG	0
Castors	C	0
Back in Stainless Steel	BS	0
Frame heater	FH	0
60Hz	60Hz	0
Pedal	PD	0

## Standard Accessories

			CU-11F
	19097771	PASTRY TRAY 600x400x120	pc 7
	19097758	SS PERFORATED BOTTOM	pc 7
	19033558	TRAY SUPPORT GUIDES L=496mm	pc 7

# Accessories

PICTURE	MODELO	REFERENCIA	DESCRIPTION	WHERE USED	€
<b>GRIDS</b>					
	EG-GN2/1	19097787	GN 2/1 EPOXY GRID	GN 2/1 UPRIGHT	-
	EG-GN1/1	19097778	GN 1/1 EPOXY GRID	GN 1/1 UPRIGHT	-
	EG-EN6040	19097776	EN600x400 EPOXY GRID	PASTRY UPRIGHT	-
	EG-SNU	19097772	560x542 EPOXY GRID	SNACK UPRIGHT	-
	EG-SNU2	19097785	500x154 EPOXY GRID	DOUBLE BODY SNACK UPRIGHT	-
<b>GRID SUPPORT KIT</b>					
	GSK-496	19033558	TRAY SUPPORT GUIDES L=496mm	PASTRY UPRIGHT	-
	GSK-613	19010200	TRAY SUPPORT GUIDES L=613mm	FISH COMPARTMENT CUD-XXG	-
	GSK-519	19015961	TRAY SUPPORT GUIDES L=519mm	FISH COMPARTMENT CUD-XXS	-
	GSK-562	19014778	TRAY SUPPORT GUIDES L=562mm	GN 2/1 UPRIGHT DOUBLE BODY	-
	GSK-662	19010206	TRAY SUPPORT GUIDES L= 662 mm	CUD-XXG REFRIGERATION COMPARTMENT	-
	GSK-532	19100845	TRAY SUPPORT GUIDES L=532 mm	GN 1/1 UPRIGHT	-
<b>PLASTIC TRAYS</b>					
	PTF-5346	19097759	530x460x100 PLASTIC TRAY FOR FISH COMPARTMENT	CUD-XXS/F	-
	PTF-5453	19097770	530x540x100 PLASTIC TRAY FOR FROZEN COMPARTMENT	CUD-XXG/N, CUD-XXS/N	-
	PTF-6040	19097771	600x400x120 PLASTIC TRAY	FISH UPRIGHT	-
<b>STAINLESS STEEL PERFORATED BOTTOM</b>					
	SSPB-6040	19097758	600x400 STAINLESS STEEL PERFORATED BOTTOM	FOR 600x400x100 TRAY	-
	SSPB-5346	19097773	530x460 STAINLESS STEEL PERFORATED BOTTOM	FOR 530x460x100 TRAY	-
	SSPB-5453	19097774	530x540 STAINLESS STEEL PERFORATED BOTTOM	FOR 530x540x100 TRAY	-
<b>MEAT HANGING BAR</b>					
	MHB-1GN	19048712	MEAT BAR GN UPRIGHTS SINGLE BODY	GN 2/1 SINGLE BODY UPRIGHT	-
	MHB-2GN	19048713	MEAT BAR GN UPRIGHTS DOUBLE BODY	GN 2/1 DOUBLE BODY UPRIGHT	-
	MHB-SN	19048715	MEAT BAR SNACK UPRIGHTS	SNACK UPRIGHT	-
<b>DOOR ORIENTATION KIT</b>					
	KDO-1-L	19098278	DOOR ORIENTATION KIT LEFT	ALL SINGLE DOOR UPRIGHT	-
	KDO-1-R	19098279	DOOR ORIENTATION KIT RIGHT		-
	KDO-2-L	19098300	DOOR ORIENTATION KIT LEFT	DOUBLE DOOR SNACK UPRIGHTS	-
	KDO-2-R	19098301	DOOR ORIENTATION KIT LEFT		-
	KDO-3-L	19098302	DOOR ORIENTATION KIT RIGHT	DOUBLE DOOR GN UPRIGHTS	-
	KDO-3-R	19098303	DOOR ORIENTATION KIT RIGHT		-
<b>CASTOR KIT</b>					
	KC-4 Ø100	19015964	KIT 4 CASTORS	ALL UPRIGHTS	-
	KC-6 Ø100	19046863	KIT 6 CASTORS	DUAL TEMPERATURE UPRIGHTS	-

# Refrigerated counters

— Features .....	<b>295</b>
— Advance 700 GN 1/1 .....	<b>299</b>
— Concept 700 GN 1/1 .....	<b>303</b>
— Refrigerated bases .....	<b>312</b>
— Snack 600 .....	<b>315</b>
— Pastry 800 EN60x40 .....	<b>321</b>
— Accessories .....	<b>322</b>

Special units or any variations from the standard model must be assembled at the factory at an additional charge over the standard model's price.

Please, contact Fagor Professional for any other variation or option that is not included on this list.







Efficiency and quality  
for professional needs.



Access the website

## Efficiency and quality for professional needs.



	<b>ADVANCE</b>	<b>CONCEPT</b>	<b>SNACK CABINETS</b>	<b>PASTRY CABINETS</b>
	ACP-3G	CCP-3G	CCP-3S	CCP-3B
Capacity (N° of shelves per door)	13	7	3	6
Size of shelves	GN 1/1	GN 1/1	405 x 460 x 2 + 405 x 525	EN 60x40
Energy class	A	C	C	D
Insulation (mm)	60 + 30	50	50	50
Refrigerant + / -	R600a	R600a	R600a	R290
Climate class (1 door)	5	4	4	4
Multiflow	Yes	No	No	No
HACCP compliant	Yes	No	No	No
Electronic control	Capacitive 5"	Capacitive 3"	Capacitive 3"	Capacitive 3"
Interface				



# Characteristics

## Electronic control Easy to use

Functional and intuitive electronic control with capacitive keyboard that allows direct access to main functions



## ECO function

Function that optimizes the performance by automatically setting temperatures, when doors are not opened so that the cooling unit works only when needed and always, efficiently.



## Climatic Class 5

Devices tested in harshest working environments, which ensure product preservation in high temperature and humidity conditions

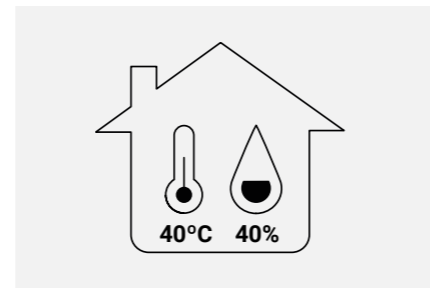

## Optimal refrigeration circuit

Internally designed forced draft cooling system with low consumption electronic components to guarantee optimal equipment efficiency and performance.



## Multiflow

Optimal air circulation system that guarantees a balanced and constant distribution throughout the equipment, so that the temperature remains uniform. It helps preserve food for longer.

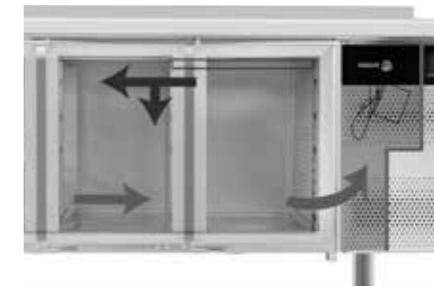

## Front breathing

The front condensation ventilation system allows the installation of equipment, without compromising performance, in such a way that it enables the correct preservation of food in the most demanding work areas.



## Removable door gasket

Removable triple camera pull-out/push-in magnetic door gasket to keep maximum hygiene and maintain the insulating properties.



## Integrated handles

Stainless steel doors with ergonomic, full-length, robust, perfectly integrated handle. that ensures practical opening of the drawers and avoids dust and dirt collection.



## Automatic closing door

Hinged doors with automatic return for a perfect closing that minimize temperature gain. Doors have a 120° dwell position and close automatically at less than 90°.



## Higher insulation thicknesses

Insulation thickness is a key factor in preventing losing cold. The new iKOLD generation increases the insulation levels of all mid ranges to provide greater cooling efficiency.



## Guide and zippers system

Removable Stainless steel rack and guide system without use of tools which allows a proper distribution of products.



## Telescopic sliding drawers

Stainless steel drawers with perforated bottom plates and telescopic sliding guides, capable of complete retraction, to economize working surface.



## Maximum stability

Height-adjustable stainless steel legs as standard. Height of the legs can be adjusted individually. In addition, there is also the option to choose swivel wheels or legs for marine.

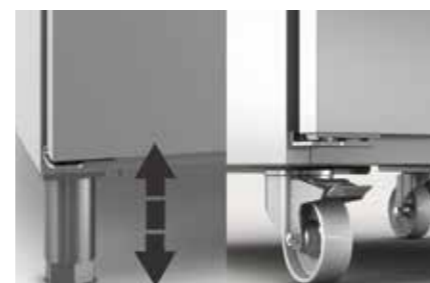

## Pivotable panel

Pivotable panel with better access to control that facilitates service, thus enlarging the useful life of the equipment



## Connectivity

Guarantee the correct conservation of stored food through precise monitoring of your refrigeration equipment thanks to Fagor Konnect.





## ADVANCE

## 700 GN 1/1



## General characteristics

- Interior and exterior completely manufactured in AISI-304 stainless steel.
- 60 mm thickness, CFC-free, high-density (40 kg/m<sup>3</sup>) polyurethane insulation, injected under high pressure.
- 30 mm stainless steel built in and polyurethane insulated working top with 100 mm high splash-back, preventing spillage behind the counter.
- Intuitive, large digital display for electronic control with energy saving function to ensure an optimal control of storing products.
- 10 HACCP alarms capacity which are store when high temperature variation and devices power failure
- Stainless steel doors with ergonomic, full-length, robust, perfectly integrated handle that ensures practical opening of the drawers and avoids dust and dirt collection.
- Stainless steel drawers with perforated bottom plates and telescopic sliding guides, capable of complete retraction, to economize working surface. Other drawer configurations are also available upon request.
- Height-adjustable stainless steel legs. Height of the legs can be adjusted individually (130 mm - 200 mm) to enable convenient cleaning.
- Rounded edge interiors, easier cleaning operations to reduce potential dirt traps with a built-in drainage to get rid of waste liquid inside units
- Removable and height adjustable epoxy coated GN 1/1 grids with a maximum loading capacity of up to 40 kg.
- Equipment with 1 GN 1/1 grids and height adjustable 2 sets of tray slides per each full door.
- Electrical power supply: 220V-240V 1N.

## Technical data

REFERENCE	19089528	19089529	19089530	19089531	19089533	19089055
MODEL	ACP-2G	ACP-3G	ACP-4G	ACN-2G	ACN-3G	ACN-4G
Energy Efficiency	A	A	A	D	D	D
Annual Consumption (kWh) (4)	423	453	584	2026	2661	2989
Gas Type	R-600a	R-600a	R-600a	R290	R290	R290
Cooling Power (kW)	0,36 (1)	0,36 (1)	0,36 (1)	0,364 (2)	0,364 (2)	0,364 (2)
Defrost	Stop	Stop	Stop	Hot Gas (3)	Hot Gas (3)	Hot Gas (3)
Electric power (kW)	0,16	160	160	0,307	0,316	0,325
Gross Volume (L)	302	446	590	302	446	590
Length (mm)	1340	1790	2240	1340	1790	2240
Depth (mm)	700	700	700	700	700	700
Height (mm)	850	850	850	850	850	850

(1) Evap. -10°C/ Cond. 55°C

(2) Evap. -25°C/ Cond. 55°C

(3) Remote version electric

(4) According to En22041 standard

## Standard Accessories

			2G	3G	4G	
	19097778	GN 1/1 EPOXY GRID	pc	2	3	4
	19015961	TRAY SUPPORT GUIDES L=519mm	pc	4	6	8



REFERENCE	DESCRIPTION	TEMPERATURE	FREQUENCY	DOOR (D)	DRAWER (H) 1/2+1/2	T DRAWER 1/3+1/3+1/3	€
19089528	ACP-2G	0°C +8 °C	50Hz	2	-	-	-
19089529	ACP-3G	0°C +8 °C	50Hz	3	-	-	-
19089530	ACP-4G	0°C +8 °C	50Hz	4	-	-	-
19089541	ACP-2G HD	0°C +8 °C	50Hz	1	1	-	-
19089542	ACP-2G HH	0°C +8 °C	50Hz	-	2	-	-
19089543	ACP-3G HDD	0°C +8 °C	50Hz	2	1	-	-
19089544	ACP-3G HHD	0°C +8 °C	50Hz	1	2	-	-
19089545	ACP-3G HHH	0°C +8 °C	50Hz	-	3	-	-
19089546	ACP-4G HDDD	0°C +8 °C	50Hz	3	1	-	-
19089547	ACP-4G HHDD	0°C +8 °C	50Hz	2	2	-	-
19089548	ACP-4G HHHD	0°C +8 °C	50Hz	1	3	-	-
19089549	ACP-4G HHHH	0°C +8 °C	50Hz	-	4	-	-
19089550	ACP-2G TT	0°C +8 °C	50Hz	-	-	2	-
19089551	ACP-3G TTT	0°C +8 °C	50Hz	-	-	3	-
19091640	ACP-4G TTTT	0°C +8 °C	50Hz	-	-	4	-
19089531	ACN-2G	-22 °C -18 °C	50Hz	2	-	-	-
19089533	ACN-3G	-22 °C -18 °C	50Hz	3	-	-	-
19089055	ACN-4G	-22 °C -18 °C	50Hz	4	-	-	-

## Options

			ACP-2G	ACP-3G	ACP-4G	ACN-2G	ACN-3G	ACN-4G
Connectivity	K		O	O	O	O	O	O
Panoramic Opening	PO		O	O	O	O	O	O
Left Group	LG		O	O	O	O	O	O
No Top	NT		O	O	O	O	O	O
No Splash-back	NS		O	O	O	O	O	O
1/2 + 1/2 Drawer	H		O	O	O	-	-	-
1/3 + 1/3 + 1/3 Drawer	T_1_3		O	O	O	-	-	-
2/3 + 1/3 Drawer	W		O	O	O	-	-	-
UK Plug (G Type)	Cl		O	O	O	O	O	O
Lock	LC		O	O	O	O	O	O
Remote Group	RG		O	O	O	O	O	O
Granit Top	GR		O	O	O	O	O	O
Castors	C		O	O	O	O	O	O
Back in Steel	BS		O	O	O	O	O	O
Frame Heater	FH		O	O	O	●	●	●
60Hz Version	60Hz		O	O	O	O	O	O

# 700 GN 1/1 Central



## General characteristics

- Interior and exterior completely manufactured in AISI-304 stainless steel.
- 60 mm thickness, CFC-free, high-density (40 kg/m<sup>3</sup>) polyurethane insulation, injected under high pressure.
- 30 mm stainless steel built in and polyurethane insulated flat working top without splashback.
- Intuitive, large digital display for electronic control with energy saving function to ensure an optimal control of storing products.
- Doors on both sides for enhance back and front access to the cooling chamber thus gaining flexibility at work.
- 10 HACCP alarms capacity wich are store when high temperature variation and devices power failure
- Stainless steel doors with ergonomic, full-length, robust, perfectly integrated handle that ensures practical opening and avoids dust and dirt collection.
- Height-adjustable stainless steel legs. Height of the legs can be adjusted individually (130 mm - 200 mm) to enable convenient cleaning.
- Rounded edge interiors, easier cleaning operations to reduce potential dirt traps with a built-in drainage to get rid of waste liquid inside units
- Removable and height adjustable epoxy coated GN 1/1 grids with a maximum loading capacity of up to 40 kg.
- Equipment with 1 GN 1/1 grids and height adjustable 2 sets of tray slides per each full door.
- Electrical power supply: 220V-240V 1N/

## Technical data

REFERENCE	MODEL	FREQUENCY	TEMPERATURE	GAS	COOLING POWER	ELECTRIC POWER	DEFROST	GROSS VOLUME	DIMENSIONS (LxDxH)	€
19089538	ACP-2G/C	50Hz	0°C +8 °C	R-600a	0,361 (1)	0,16	Stop	302	1340 x 768 x 850	-
19089539	ACP-3G/C	50Hz	0°C +8 °C	R-600a	0,361 (1)	0,16	Stop	446	1790 x 768 x 850	-
19089540	ACP-4G/C	50Hz	0°C +8 °C	R-600a	0,361 (1)	0,16	Stop	590	2240 x 768 x 850	-

(1) Evap. -10°C/ Cond. 55°C

## Options

		ACP-2G/C	ACP-3G/C	ACP-4G/C
Connectivity	K	O	O	O
Panoramic Opening	PO		O	O
Left Group	LG		O	O
No Top	NT		O	O
No Splash-back	NS		●	●
UK Plug (G Type)	CI		O	O
Lock	LC	O	O	O
Remote Group	RG	O	O	O

		ACP-2G/C	ACP-3G/C	ACP-4G/C
Castors	C	O	O	O
Frame Heater	FH	O	O	O
60Hz Version	60Hz	O	O	O

## Standard Accessories

			2G	3G	4G	
	19097778	GN 1/1 EPOXY GRID	pc	2	3	4
	19010200	TRAY SUPPORT GUIDES L=613mm	pc	4	6	8

# 700 GN 1/1 Display



## General characteristics

- Interior and exterior completely manufactured in AISI-304 stainless steel.
- 60 mm thickness, CFC-free, high-density (40 kg/m<sup>3</sup>) polyurethane insulation, injected under high pressure.
- 30 mm stainless steel built in and polyurethane insulated working top with 100 mm high splash-back, preventing spillage behind the counter.
- Double-glazed doors insulated with low thermal emissivity to reduce heat transfer with ergonomic handle.
- Intuitive, large digital display for electronic control with energy saving function to ensure an optimal control of storing products.
- 10 HACCP alarms capacity wich are store when high temperature variation and devices power failure
- Height-adjustable stainless steel legs. Height of the legs can be adjusted individually (130 mm - 200 mm) to enable convenient cleaning.
- Rounded edge interiors, easier cleaning operations to reduce potential dirt traps with a built-in drainage to get rid of waste liquid inside units
- Removable and height adjustable epoxy coated GN 1/1 grids with a maximum loading capacity of up to 40 kg.
- Equipment with 1 GN 1/1 grids and height adjustable 2 sets of tray slides per each full door.
- Electrical power supply: 220V-240V 1N.

## Technical data

REFERENCE	MODEL	FREQUENCY	TEMPERATURE	GAS	COOLING POWER	ELECTRIC POWER	DEFROST	ANNUAL CONSUMPTION	GROSS VOLUME (L)	ENERGY EFFICIENCY CLASS	DIMENSIONS	€
19089535	ACP-2G GD	50Hz	0°C +8 °C	R-600a	0,361 (1)	0,17	STOP	697 (5)	302	D	1340 x 700 x 850	-
19089536	ACP-3G GD	50Hz	0°C +8 °C	R-600a	0,361 (1)	0,17	STOP	730 (5)	446	C	1790 x 700 x 850	-
19089537	ACP-4G GD	50Hz	0°C +8 °C	R-600a	0,361 (1)	0,17	STOP	949 (5)	590	D	2240 x 700 x 850	-

(1) Evap. -10°C/ Cond. 45°C

(5) According to EN23953 standard

## Options

		ACP-2G GD	ACP-3G GD	ACP-4G GD
Connectivity	K	O	O	O
Panoramic Opening	PO		O	O
Left Group	LG		O	O
No Top	NT		O	O
No Splash-back	NS		O	O
UK Plug (G Type)	CI		O	O
Lock	LC	●	●	●
Remote Group	RG	O	O	O

		ACP-2G GD	ACP-3G GD	ACP-4G GD
Granite Top	GR	O	O	O
Castors	C	O	O	O
Back in Steel	BS	O	O	O
Frame heater	FH	O	O	O
60Hz	60Hz	O	O	O

## Standard Accessories

			2G	3G	4G	
	19097778	GN 1/1 EPOXY GRID	pc	2	3	4
	19015961	TRAY SUPPORT GUIDES L=519mm	pc	4	6	8

CONCEPT

# 700 GN 1/1



### General characteristics

- Interior constructed with AISI-304 stainless steel exterior in food grade stainless steel.
- 50 mm thickness, CFC-free, high-density (40 kg/m<sup>3</sup>) polyurethane insulation, injected under high pressure.
- Heavy-duty stainless-steel working top with 100mm high splash-back, preventing spillage behind the counter.
- Intuitive, digital display for electronic control with energy saving function to ensure an optimal control of storing products.
- Stainless steel doors with ergonomic, full-length, robust, perfectly integrated handle that avoids dust and dirt collection.
- Stainless steel drawers with perforated bottom plates and telescopic sliding guides, capable of complete retraction, to economize working surface. Other drawer configurations are also available upon request.
- Height-adjustable stainless steel legs. Height of the legs can be adjusted individually (130 mm - 200 mm) to enable convenient cleaning.
- Stamped edge interiors, easier cleaning operations to reduce potential dirt traps with a built-in drainage to get rid of waste liquid inside units
- Removable and height adjustable epoxy coated GN 1/1 grids with a maximum loading capacity of up to 40 kg.
- Equipment with 1 GN 1/1 grids and height adjustable 2 sets of tray slides per each full door.
- Electrical power supply: 220V-240V 1N.

### Technical data

REFERENCE	19089552	19089554	19089556	19089561	19089563
MODEL	CCP-2G	CCP-3G	CCP-4G	CCN-2G	CCN-3G
Energy Efficiency	B	C	C	D	E
Annual Consumption (kWh) (4)	752 (4)	931 (4)	1096 (4)	2120 (4)	2879 (4)
Gas Type	R-600a	R-600a	R-600a	R290	R290
Cooling Power (kW)	0,361 (1)	0,361 (1)	0,436 (1)	0,364 (2)	0,364 (2)
Defrost	STOP	STOP	STOP	ELECTRIC	ELECTRIC
Electric power (kW)	0,203	0,203	0,224	0,317	0,326
Gross Volume (L)	274	428	581	274	428
Length (mm)	1342	1792	2242	1342	1792
Depth (mm)	700	700	700	700	700
Height (mm)	850	850	850	850	850

(1) Evap. -10°C/ Cond. 55°C      (2) Evap. -25°C/ Cond. 55°C      (4) According to En22041 standard

### Standard Accessories

				2G	3G	4G
	19097778	GN 1/1 EPOXY GRID	pc	2	3	4
	19014778	TRAY SUPPORT GUIDES L=562mm	pc	4	6	8



REFERENCE	DESCRIPTION	TEMPERATURE	FREQUENCY	DOOR (D)	DRAWER (H) 1/2 + 1/2	T DRAWER 1/3 + 1/3 + 1/3	€
19089552	CCP-2G	0°C +8 °C	50Hz	2	-	-	-
19089554	CCP-3G	0°C +8 °C	50Hz	3	-	-	-
19089556	CCP-4G	0°C +8 °C	50Hz	4	-	-	-
19089567	CCP-2G HD	0°C +8 °C	50Hz	1	1	-	-
19089568	CCP-2G HH	0°C +8 °C	50Hz	0	2	-	-
19089569	CCP-3G HDD	0°C +8 °C	50Hz	2	1	-	-
19089570	CCP-3G HHD	0°C +8 °C	50Hz	1	2	-	-
19089571	CCP-3G HHH	0°C +8 °C	50Hz	0	3	-	-
19089572	CCP-4G HDDD	0°C +8 °C	50Hz	3	1	-	-
19089573	CCP-4G HHDD	0°C +8 °C	50Hz	2	2	-	-
19089574	CCP-4G HHHD	0°C +8 °C	50Hz	1	3	-	-
19089575	CCP-4G HHHH	0°C +8 °C	50Hz	0	4	-	-
19089561	CCN-2G	-18°C / -22°C	50Hz	2	-	-	-
19089563	CCN-3G	-18°C / -22°C	50Hz	3	-	-	-

### Options

			CCP-2G	CCP-3G	CCP-4G	CCN-2G	CCN-3G
Panoramic Opening	PO		0	0	0	0	0
Left Group	LG		0	0	0	0	0
No Top	NT		0	0	0	0	0
No Splash-back	NS		0	0	0	0	0
1/2 + 1/2 Drawer	H		0	0	0	-	-
1/3 + 1/3 + 1/3 Drawer	T_1_3		0	0	0	-	-
2/3 + 1/3 Drawer	W		0	0	0	-	-
UK Plug (G Type)	CI		0	0	0	0	0
Lock	LC		0	0	0	0	0
Granite Top	GR		0	0	0	0	0
Castors	C		0	0	0	0	0
Back in Stainless Steel	BS		0	0	0	0	0
Frame Heater	FH		0	0	0	●	●
60Hz Version	60Hz		0	0	0	0	0

CONCEPT

# 700 GN 1/1 with Sinks



### General characteristics

- Interior constructed with AISI-304 stainless steel exterior in food grade stainless steel.
- 50 mm thickness, CFC-free, high-density (40 kg/m<sup>3</sup>) polyurethane insulation, injected under high pressure.
- Heavy-duty stainless-steel working top with 100mm high splash-back, preventing spillage behind the counter with 330x330x200 mm stamped bowl.
- Intuitive, digital display for electronic control with energy saving function to ensure an optimal control of storing products.
- Stainless steel doors with ergonomic, full-length, robust, perfectly integrated handle that avoids dust and dirt collection.
- Stainless steel drawers with perforated bottom plates and telescopic

- sliding guides, capable of complete retraction, to economize working surface. Other drawer configurations are also available upon request.
- Height-adjustable stainless steel legs. Height of the legs can be adjusted individually (130 mm - 200 mm) to enable convenient cleaning.
- Stamped edge interiors, easier cleaning operations to reduce potential dirt traps with a built-in drainage to get rid of waste liquid inside units
- Removable and height adjustable epoxy coated GN 1/1 grids with a maximum loading capacity of up to 40 kg.
- Equipment with 1 GN 1/1 grids and height adjustable 2 sets of tray slides per each full door.
- Electrical power supply: 220V-240V 1N.

### Technical data

REFERENCE	MODEL	FREQUENCY	TEMPERATURE	GAS	COOLING POWER (kW)	ELECTRIC POWER (kW)	DEFROST	GROSS VOLUME (L)	ANNUAL CONSUMPTION (kWh)	ENERGY EFFICIENCY CLASS	DIMENSIONS	€
19089591	CCP-2G-S	50Hz	0°C +8 °C	R-600a	0,361 (1)	0,203	STOP	274	752 (4)	B	1342 x 700 x 850	-
19089592	CCP-3G-S	50Hz	0°C +8 °C	R-600a	0,361 (1)	0,203	STOP	428	931 (4)	C	1792 x 700 x 850	-
19089593	CCP-4G-S	50Hz	0°C +8 °C	R-600a	0,436 (1)	0,224	STOP	581	1096 (4)	C	2242 x 700 x 850	-
19106963	CCN-2G/S	50Hz	-18°C -22°C	R-290	0,364 (2)	0,317	ELECTRIC	274	2120 (4)	D	1342 x 700 x 850	-
19106020	CCN-3G/S	50Hz	-18°C -22°C	R-290	0,364 (2)	0,326	ELECTRIC	428	2879 (4)	E	1792 x 700 x 850	-

(1) Evap. -10°C/ Cond. 55°C (2) Evap. -25°C/ Cond. 55°C (4) According to En22041 standard

### Options

			CCP-2G-S	CCP-3G-S	CCP-4G-S	CCN-2G-S	CCN-3G-S
Panoramic Opening	PO		0	0	0	0	0
Left Group	LG		0	0	0	0	0
No Splash-back	NS		0	0	0	0	0
1/2 + 1/2 Drawer	H		0	0	0	-	-
1/3 + 1/3 + 1/3 Drawer	T_1_3		0	0	0	-	-
1/3 + 2/3 Drawer	W		0	0	0	-	-
UK Plug (G Type)	CI		0	0	0	0	0

			CCP-2G-S	CCP-3G-S	CCP-4G-S	CCN-2G-S	CCN-3G-S
Lock	LC		0	0	0	0	0
Back in Stainless Steel	BS		0	0	0	0	0
Castors	C		0	0	0	●	●
Frame Heater	FH		0	0	0	0	0
60Hz Version	60Hz		0	0	0	0	0

### Standard Accessories

				2G	3G	4G
	19097778	GN 1/1 EPOXY GRID	pc	2	3	4
	19014778	TRAY SUPPORT GUIDES L=562mm	pc	4	6	8

CONCEPT

# 700 GN 1/1 Central



### General characteristics

- Interior constructed with AISI-304 stainless steel exterior in food grade stainless steel.
- 50 mm thickness, CFC-free, high-density (40 kg/m<sup>3</sup>) polyurethane insulation, injected under high pressure.
- Heavy-duty stainless-steel flat working top without splashback.
- Intuitive, digital display for electronic control with energy saving function to ensure an optimal control of storing products.
- Doors on both sides for enhance back and front access to the cooling chamber thus gaining flexibility at work.
- Stainless steel doors with ergonomic, full-length, robust, perfectly integrated handle that avoids dust and dirt collection.

- Height-adjustable stainless steel legs. Height of the legs can be adjusted individually (130 mm - 200 mm) to enable convenient cleaning.
- Stamped edge interiors, easier cleaning operations to reduce potential dirt traps with a built-in drainage to get rid of waste liquid inside units
- Removable and height adjustable epoxy coated GN 1/1 grids with a maximum loading capacity of up to 40 kg.
- Equipment with 1 GN 1/1 grids and height adjustable 2 sets of tray slides per each full door.
- Electrical power supply: 220V-240V 1N.

### Technical data

REFERENCE	MODEL	FREQUENCY	TEMPERATURE	GAS	COOLING POWER	ELECTRIC POWER	DEFROST	GROSS VOLUME (L)	DIMENSIONS	€
19089594	CCPC-2G/C	50Hz	0°C +8 °C	R-600a	0,361 (1)	0,203	STOP	274	1342 x 778 x 850	-
19089595	CCPC-3G/C	50Hz	0°C +8 °C	R-600a	0,361 (1)	0,203	STOP	428	1792 x 778 x 850	-
19089596	CCPC-4G/C	50Hz	0°C +8 °C	R-600a	0,436 (1)	0,224	STOP	581	2242 x 778 x 850	-

(1) Evap. -10°C/ Cond. 45°C (5) According to EN23953 standard

### Options

			CCPC-2G/C	CCPC-3G/C	CCPC-4G/C
Panoramic Opening	PO		0	0	0
No Top	NT		0	0	0
No Splash-back	NS		●	●	●
UK Plug (G Type)	CI		0	0	0
Lock	LC		0	0	0
Frame heater	FH		0	0	0
60Hz	60Hz		0	0	0

### Standard Accessories

				2G	3G	4G
	19097778	GN 1/1 EPOXY GRID	pc	2	3	4
	19010200	TRAY SUPPORT GUIDES L=613mm		4	6	8



CONCEPT

# 700 GN 1/1 Remote



### General characteristics

- Interior constructed with AISI-304 stainless steel exterior in food grade stainless steel.
- 50 mm thickness, CFC-free, high-density (40 kg/m<sup>3</sup>) polyurethane insulation, injected under high pressure.
- Heavy-duty stainless-steel working top with 100mm high splash-back, preventing spillage behind the counter.
- Intuitive, digital display for electronic control with energy saving function to ensure an optimal control of storing products.
- Equipment without unit condenser, ready for remote cooling unit connection.
- Height-adjustable stainless steel legs. Height of the legs can be adjusted individually (130 mm - 200 mm) to enable convenient cleaning.
- Stamped edge interiors, easier cleaning operations to reduce potential dirt traps with a built-in drainage to get rid of waste liquid inside units
- Removable and height adjustable epoxy coated GN 1/1 grids with a maximum loading capacity of up to 40 kg.
- Equipment with 1 GN 1/1 grids and height adjustable 2 sets of tray slides per each full door.
- Electrical power supply: 220V-240V 1N

### Technical data

	19089558	19089559	19089560	19089565	19089566
	CCP-2G/R	CCP-3G/R	CCP-4G/R	CCN-2G/R	CCN-3G/R
Energy Efficiency	-	-	-	-	-
Annual Consumption (kWh) (1)	-	-	-	-	-
Gas Type	(6)	(6)	(6)	(6)	(6)
Cooling Power (kW)	0,361 (1)	0,361 (1)	0,436 (1)	0,364 (2)	0,364 (2)
Defrost	STOP	STOP	STOP	ELECTRIC	ELECTRIC
Electric power (kW)	0,029	0,029	0,029	0,064	0,073
Gross Volume (L)	274	428	581	274	428
Length (mm)	1042	1492	1942	1042	1492
Depth (mm)	700	700	700	700	700
Height (mm)	850	850	850	850	850

(1) Evap. -10°C/ Cond. 55°C

(2) Evap. -25°C/ Cond. 55°C

(6) Consult the manufacturer

### Standard Accessories

				2G	3G	4G
	19097778	GN 1/1 EPOXY GRID	pc	2	3	4
	19014778	TRAY SUPPORT GUIDES L=562mm	pc	4	6	8



REFERENCE	DESCRIPTION	TEMPERATURE	FREQUENCY	DOOR (D)	DRAWER (H) 1/2 + 1/2	€
19089558	CCP-2G/R	0°C +8 °C	50/60	2	-	-
19089559	CCP-3G/R	0°C +8 °C	50/60	3	-	-
19089560	CCP-4G/R	0°C +8 °C	50/60	4	-	-
19089576	CCP-2G/R HD	0°C +8 °C	50/60	1	1	-
19089577	CCP-2G/R HH	0°C +8 °C	50/60	-	2	-
19089578	CCP-3G/R HDD	0°C +8 °C	50/60	2	1	-
19089579	CCP-3G/R HHD	0°C +8 °C	50/60	1	2	-
19089580	CCP-3G/R HHH	0°C +8 °C	50/60	-	3	-
19089581	CCP-4G/R HDDD	0°C +8 °C	50/60	3	1	-
19089582	CCP-4G/R HHDD	0°C +8 °C	50/60	2	2	-
19089583	CCP-4G/R HHHH	0°C +8 °C	50/60	1	3	-
19089584	CCP-4G/R HHHH	0°C +8 °C	50/60	-	4	-
19089565	CCN-2G/R	-18°C / -22°C	50/60	2	-	-
19089566	CCN-3G/R	-18°C / -22°C	50/60	3	-	-

### Options

			CCP-2G/R	CCP-3G/R	CCP-4G/R	CCN-2G/R	CCN-3G/R
Panoramic Opening	PO		0	0	0	0	0
No Top	NT		0	0	0	0	0
No Splash-back	NS		0	0	0	0	0
1/2 + 1/2 Drawer	H		0	0	0	-	-
1/3 + 1/3 + 1/3 Drawer	T_1_3		0	0	0	-	-
2/3 + 1/3 Drawer	W		0	0	0	-	-
UK Plug (G Type)	CI		0	0	0	0	0
Lock	LC		0	0	0	0	0
Granite Top	GR		0	0	0	0	0
Back in Stainless Steel	BS		0	0	0	0	0
Frame Heater	FH		0	0	0	●	●

CONCEPT

# 700 GN 1/1 Display



### General characteristics

- Interior constructed with AISI-304 stainless steel exterior in food grade stainless steel.
- 50 mm thickness, CFC-free, high-density (40 kg/m<sup>3</sup>) polyurethane insulation, injected under high pressure.
- Heavy-duty stainless-steel working top with 100mm high splash-back, preventing spillage behind the counter.
- Intuitive, digital display for electronic control with energy saving function to ensure an optimal control of storing products.
- Double-glazed doors insulated with low thermal emissivity to reduce heat transfer with ergonomic handle.
- Height-adjustable stainless steel legs. Height of the legs can be adjusted individually (130 mm - 200 mm) to enable convenient cleaning.
- Stamped edge interiors, easier cleaning operations to reduce potential dirt traps with a built-in drainage to get rid of waste liquid inside units
- Removable and height adjustable epoxy coated GN 1/1 grids with a maximum loading capacity of up to 40 kg.
- Equipment with 1 GN 1/1 grids and height adjustable 2 sets of tray slides per each full door.
- Electrical power supply: 220V-240V 1N.

### Technical data

REFERENCE	MODEL	FREQUENCY	TEMPERATURE	GAS	COOLING POWER (kW)	ELECTRIC POWER (kW)	DEFROST	GROSS VOLUME (L)	ANNUAL CONSUMPTION (kWh)	ENERGY EFFICIENCY CLASS	DIMENSIONS	€
19089585	CCP-2G GD	50Hz	0°C +8 °C	R-600a	0,361 (1)	0,205	STOP	274	1241 (5)	C	1342 x 700 x 850	-
19089586	CCP-3G GD	50Hz	0°C +8 °C	R-600a	0,361 (1)	0,207	STOP	428	1536 (5)	C	1792 x 700 x 850	-
19089587	CCP-4G GD	50Hz	0°C +8 °C	R-600a	0,436 (1)	0,23	STOP	581	1808 (5)	C	2242 x 700 x 850	-

(1) Evap. -10°C/ Cond. 45°C (5) According to EN23953 standard

### Options

			CCP-2G GD	CCP-3G GD	CCP-4G GD
Panoramic Opening	PO		0	0	0
Left Group	LG		0	0	0
No Top	NT		0	0	0
No Splash-back	NS		0	0	0
UK Plug (G Type)	CI		0	0	0
Lock	LC		●	●	●
Granite Top	GR		0	0	0
Castors	C		0	0	0

### Standard Accessories

				2G	3G	4G
	19097778	GN 1/1 EPOXY GRID	pc	2	3	4
	19014778	TRAY SUPPORT GUIDES L=562mm	pc	4	6	8

CONCEPT

# 700 GN 1/1 Display Remote



### General characteristics

- Interior constructed with AISI-304 stainless steel exterior in food grade stainless steel.
- 50 mm thickness, CFC-free, high-density (40 kg/m<sup>3</sup>) polyurethane insulation, injected under high pressure.
- Heavy-duty stainless-steel working top with 100mm high splash-back, preventing spillage behind the counter.
- Intuitive, digital display for electronic control with energy saving function to ensure an optimal control of storing products.
- Equipment without unit condenser, ready for remote cooling unit connection.
- Double-glazed doors insulated with low thermal emissivity to reduce heat transfer with ergonomic handle.
- Height-adjustable stainless steel legs. Height of the legs can be adjusted individually (130 mm - 200 mm) to enable convenient cleaning.
- Stamped edge interiors, easier cleaning operations to reduce potential dirt traps with a built-in drainage to get rid of waste liquid inside units
- Removable and height adjustable epoxy coated GN 1/1 grids with a maximum loading capacity of up to 40 kg.
- Equipment with 1 GN 1/1 grids and height adjustable 2 sets of tray slides per each full door.
- Electrical power supply: 220V-240V 1N.

### Technical data

REFERENCE	MODEL	FREQUENCY	TEMPERATURE	COOLING POWER	ELECTRIC POWER	DEFROST	GROSS VOLUME (L)	DIMENSIONS	€
19089588	CCP-2G/R GD	50/60Hz	0°C +8 °C	0,361 (1)	0,031	STOP	274	1042 x 700 x 850	-
19089589	CCP-3G/R GD	50/60Hz	0°C +8 °C	0,361 (1)	0,033	STOP	428	1492 x 700 x 850	-
19089590	CCP-4G/R GD	50/60Hz	0°C +8 °C	0,436 (1)	0,035	STOP	581	1942 x 700 x 850	-

(1) Evap. -10°C/ Cond. 45°C

### Options

			CCP-2G/R GD	CCP-3G/R GD	CCP-4G/R GD
Panoramic Opening	PO		0	0	0
No Top	NT		0	0	0
No Splash-back	NS		0	0	0
UK Plug (G Type)	CI		0	0	0
Lock	LC		●	●	●
Granite Top	GR		0	0	0
Back in Stainless Steel	BS		0	0	0
Frame heater	FH		0	0	0

### Standard Accessories

				2G	3G	4G
	19097778	GN 1/1 EPOXY GRID	pc	2	3	4
	19014778	TRAY SUPPORT GUIDES L=562mm		4	6	8

CONCEPT

# 700 GN 1/1 Refrigerated bases



### General characteristics

- Interior constructed with AISI-304 stainless steel exterior in food grade stainless steel.
- 50 mm thickness, CFC-free, high-density (40 kg/m<sup>3</sup>) polyurethane insulation, injected under high pressure.
- Heavy-duty stainless-steel working top with 100mm high splash-back, preventing spillage behind the counter.
- Intuitive, digital display for electronic control with energy saving function to ensure an optimal control of storing products.
- Intended to give support to counter top cooking equipment. Ideal for refrigeration solutions in small rooms.
- Height-adjustable stainless steel legs. Height of the legs can be adjusted individually (130 mm - 200 mm) to enable convenient cleaning.
- Stamped edge interiors, easier cleaning operations to reduce potential dirt traps with a built-in drainage to get rid of waste liquid inside units
- Removable and height adjustable epoxy coated GN 1/1 grids with a maximum loading capacity of up to 40 kg.
- Equipment with 1 GN 1/1 grids and height adjustable 2 sets of tray slides per each full door.
- Electrical power supply: 220V-240V 1N.

### Technical data

	19089597 CCPB-2G	19089599 CCPB-3G	19089601 CCPB-4G
Energy Efficiency	C	C	D
Annual Consumption (kWh) (4)	956	1095	1245
Gas Type	R-600a	R-600a	R-600a
Cooling Power (kW)	0,361 (1)	0,361 (1)	0,436 (1)
Defrost	STOP	STOP	STOP
Electric power (kW)	0,203	0,203	0,224
Gross Volume (L)	177	277	377
Length (mm)	1342	1792	2242
Depth (mm)	700	700	700
Height (mm)	584	584	584
	(1) Evap. -10°C/ Cond. 55°C	(2) Evap. -25°C/ Cond. 55°C	(4) According to En22041 standard

### Standard Accessories

			2G	3G	4G	
	19097778	GN 1/1 EPOXY GRID	pc	2	3	4
	19014778	TRAY SUPPORT GUIDES L=562mm	pc	4	6	8

REFERENCE	DESCRIPTION	TEMPERATURE	FREQUENCY	DOOR (D)	DRAWER (W) 2/3	DRAWER (T) 1/3 + 1/3	€
19089597	CCPB-2G	0°C +8 °C	50Hz	2	-	-	-
19089599	CCPB-3G	0°C +8 °C	50Hz	3	-	-	-
19089601	CCPB-4G	0°C +8 °C	50Hz	4	-	-	-
19089603	CCPB-2G W	0°C +8 °C	50Hz	-	2	-	-
19089605	CCPB-3G W	0°C +8 °C	50Hz	-	3	-	-
19089607	CCPB-4G W	0°C +8 °C	50Hz	-	4	-	-
19089609	CCPB-2G T	0°C +8 °C	50Hz	1	-	1	-
19089611	CCPB-3G T	0°C +8 °C	50Hz	1	-	2	-
19089613	CCPB-4G T	0°C +8 °C	50Hz	1	-	3	-

### Options

			CCPB-2G	CCPB-3G	CCPB-4G
Panoramic Opening	PO		0	0	0
No Splash-back	NS		●	●	●
2/3 + 1/3 Drawer	W		0	0	0
UK Plug (G Type)	CI		0	0	0
Lock	LC		0	0	0
Castors	C		0	0	0
Back in Stainless Steel	BS		0	0	0
Frame heater	FH		0	0	0
60Hz	60Hz		0	0	0

# Refrigerated base 700



## General characteristics

- Interior constructed with AISI-304 stainless steel exterior in food grade stainless steel.
- 50 mm thickness, CFC-free, high-density (40 kg/m³) polyurethane insulation, injected under high pressure.
- Heavy-duty stainless-steel working top with 100mm high splash-back, preventing spillage behind the counter.
- Intuitive, digital display for electronic control with energy saving function to ensure an optimal control of storing products.
- Stainless steel doors with ergonomic, full-length, robust, perfectly integrated handle that avoids dust and dirt collection

- Height-adjustable stainless steel legs. Height of the legs can be adjusted individually (130 mm - 200 mm) to enable convenient cleaning.
- Stamped edge interiors, easier cleaning operations to reduce potential dirt traps with a built-in drainage to get rid of waste liquid inside units
- Removable and height adjustable epoxy coated GN 2/3 grids with a maximum loading capacity of up to 40 kg.
- Equipment with 1 GN 2/3 grids and height adjustable 2 sets of tray slides per each full door.
- W model drawers with GN 2/3 holding capacity.
- W2 model drawers with 2x GN 2/3 holding capacity.
- Electrical power supply: 220V-240V 1N.

## Technical data

REFERENCE	MODEL	FREQUENCY	TEMPERATURE	GAS	COOLING POWER (kW)	ELECTRIC POWER (kW)	DEFROST	GROSS VOLUME (L)	ANNUAL CONSUMPTION (kWh)	ENERGY EFFICIENCY CLASS	DIMENSIONS	€
19104999	CCP7-2G	50Hz	0°C +8 °C	R-290	0,369 (1)	0,249	STOP	110	730 (4)	B	1200 x 630 x 590	-
19105020	CCP7-2G W	50Hz	0°C +8 °C	R-290	0,369 (1)	0,249	STOP	110	730 (4)	B	1200 x 630 x 590	-
19105021	CCP7-2G W2	50Hz	0°C +8 °C	R-290	0,369 (1)	0,262	STOP	110	730 (4)	C	1200 x 630 x 590	-
19105022	CCP7-3G	50Hz	0°C +8 °C	R-290	0,369 (1)	0,249	STOP	169	1245 (4)	D	1600 x 630 x 590	-
19105023	CCP7-3G W	50Hz	0°C +8 °C	R-290	0,369 (1)	0,249	STOP	169	1245 (4)	D	1600 x 630 x 590	-

(1) Evap. -10°C/ Cond. 55°C (4) According to En22041 standard

## Options

			CCP7-2G	CCP7-3G
Panoramic Opening	PO		●	●
No Splash-back	NS		●	●
UK Plug (G Type)	CI		0	0
Remote Group	RG		0	0
Castors	C		0	0
Back in Stainless Steel	BS		●	●

		CCP7-2G	CCP7-3G
Frame heater	FH	0	0
60Hz	60Hz	0	0

## Standard Accessories

			2G	3G
	19106414	GN 2/3 EPOXY GRID	2	3
	19033558	TRAY SUPPORT GUIDES L=496mm	4	6

# Refrigerated base 900



## General characteristics

- Interior constructed with AISI-304 stainless steel exterior in food grade stainless steel.
- 50 mm thickness, CFC-free, high-density (40 kg/m³) polyurethane insulation, injected under high pressure.
- Heavy-duty stainless-steel working top with 100mm high splash-back, preventing spillage behind the counter.
- Intuitive, digital display for electronic control with energy saving function to ensure an optimal control of storing products.
- Stainless steel doors with ergonomic, full-length, robust, perfectly integrated handle that avoids dust and dirt collection.

- Height-adjustable stainless steel legs. Height of the legs can be adjusted individually (130 mm - 200 mm) to enable convenient cleaning.
- Stamped edge interiors, easier cleaning operations to reduce potential dirt traps with a built-in drainage to get rid of waste liquid inside units
- Removable and height adjustable epoxy coated GN 1/1 grids with a maximum loading capacity of up to 40 kg.
- Equipment with 1 GN 1/1 grids and height adjustable 2 sets of tray slides per each full door.
- W model drawers with GN 1/1 holding capacity.
- W2 model drawers with 2 x GN 1/1 OR 1x GN 2/1 holding capacity.
- Electrical power supply: 220V-240V 1N.

## Technical data

REFERENCE	MODEL	FREQUENCY	TEMPERATURE	GAS	COOLING POWER (kW)	ELECTRIC POWER (kW)	DEFROST	GROSS VOLUME (L)	ANNUAL CONSUMPTION (kWh)	ENERGY EFFICIENCY CLASS	DIMENSIONS	€
19105024	CCP9-2G	50Hz	0°C +8 °C	R-290	0,369 (1)	0,25	STOP	169	730 (4)	B	1207 x 840 x 590	-
19105025	CCP9-2G W	50Hz	0°C +8 °C	R-290	0,369 (1)	0,25	STOP	169	730 (4)	B	1207 x 840 x 590	-
19105026	CCP9-2G W2	50Hz	0°C +8 °C	R-290	0,369 (1)	0,262	STOP	169	730 (4)	C	1207 x 840 x 590	-
19105027	CCP9-3G	50Hz	0°C +8 °C	R-290	0,369 (1)	0,249	STOP	240	1245 (4)	D	1607 x 840 x 590	-
19105028	CCP9-3G W	50Hz	0°C +8 °C	R-290	0,369 (1)	0,249	STOP	240	1245 (4)	D	1607 x 840 x 590	-

(1) Evap. -10°C/ Cond. 55°C (4) According to En22041 standard

## Options

			CCP9-2G	CCP9-3G
Panoramic Opening	PO		●	●
No Splash-back	NS		●	●
UK Plug (G Type)	CI		0	0
Remote Group	RG		0	0
Castors	C		0	0
Back in Stainless Steel	BS		●	●

			CCP9-2G	CCP9-3G
Frame heater	FH		0	0
60Hz	60Hz		0	0

## Standard Accessories

			2G	3G
	19097778	GN 1/1 EPOXY GRID	2	3
	19033557	TRAY SUPPORT GUIDES L=649mm	4	6



# 600 Snack



## General characteristics

- Interior constructed with AISI-304 stainless steel exterior in food grade stainless steel.
- 50 mm thickness, CFC-free, high-density (40 kg/m<sup>3</sup>) polyurethane insulation, injected under high pressure.
- Heavy-duty stainless-steel working top with 100mm high splash-back, preventing spillage behind the counter.
- Intuitive, digital display for electronic control with energy saving function to ensure an optimal control of storing products.
- Stainless steel doors with ergonomic, full-length, robust, perfectly integrated handle that avoids dust and dirt collection.
- Stainless steel drawers with perforated bottom plates and telescopic sliding guides, capable of complete retraction, to economize working surface. Other drawer configurations are also available upon request.
- Height-adjustable stainless steel legs. Height of the legs can be adjusted individually (130 mm - 200 mm) to enable convenient cleaning.
- Stamped edge interiors, easier cleaning operations to reduce potential dirt traps with a built-in drainage to get rid of waste liquid inside units
- Removable and height adjustable epoxy coated grids with a maximum loading capacity of up to 40 kg.
- Equipped with 1 grid 405x460 mm in each edge door and 1 grid 405x525 in centered doors and height adjustable 2 sets of tray slides per each full door.
- Electrical power supply: 220V-240V 1N.

## Technical data

	19089625	19089627	19089629	19089634	19089636
	CCP-2S	CCP-3S	CCP-4S	CCN-2S	CCN-3S
Energy Efficiency	B	C	C	D	E
Annual Consumption (kWh) (4)	836	931	1096	2120	2879
Gas Type	R-600a	R-600a	R-600a	R290	R290
Cooling Power (kW)	0,361 (1)	0,361 (1)	0,436 (1)	0,364 (2)	0,364 (2)
Defrost	STOP	STOP	STOP	ELECTRIC	ELECTRIC
Electric power (kW)	0,203	0,203	0,224	0,317	0,326
Gross Volume (L)	268	416	564	268	416
Length (mm)	1492	2017	2542	1492	2017
Depth (mm)	600	600	600	600	600
Height (mm)	850	850	850	850	850

(1) Evap. -10°C/ Cond. 55°C

(2) Evap. -25°C/ Cond. 55°C

(4) According to En22041 standard

## Standard Accessories

				2S	3S	4S
	19097777	EPOXY GRID SACK 405x460	pc	2	2	2
	19097775	EPOXY GRID SACK 405x525	pc	0	1	2



REFERENCE	DESCRIPTION	TEMPERATURE	FREQUENCY	DOOR (D)	DRAWER (H) 1/2 + 1/2	€
19089625	CCP-2S	0°C +8 °C	50	2	-	-
19089627	CCP-3S	0°C +8 °C	50	3	-	-
19089629	CCP-4S	0°C +8 °C	50	4	-	-
19089640	CCP-2S HD	0°C +8 °C	50	1	1	-
19089641	CCP-2S HH	0°C +8 °C	50	-	2	-
19089642	CCP-3S HDD	0°C +8 °C	50	2	1	-
19089643	CCP-3S HHD	0°C +8 °C	50	1	2	-
19089644	CCP-3S HHH	0°C +8 °C	50	-	3	-
19089645	CCP-4S HDDD	0°C +8 °C	50	3	1	-
19089646	CCP-4S HHDD	0°C +8 °C	50	2	2	-
19089647	CCP-4S HHHH	0°C +8 °C	50	1	3	-
19089648	CCP-4S HHHH	0°C +8 °C	50	-	4	-
⊙ STOCK	19089634	CCN-2S	-18°C / -22°C	2	-	-
⊙ STOCK	19089636	CCN-3S	-18°C / -22°C	3	-	-

## Options

			CCP-2S	CCP-3S	CCP-4S	CCN-2S	CCN-3S
Panoramic Opening	PO		0	0	0	0	0
No Top	NT		0	0	0	0	0
No Splash-back	NS		0	0	0	0	0
1/2 + 1/2 Drawer	H		0	0	0	0	0
1/3 + 1/3 + 1/3 Drawer	T_1_3		0	0	0	-	-
2/3 + 1/3 Drawer	W		0	0	0	-	-
UK Plug (G Type)	CI		0	0	0	-	-
Lock	LC		0	0	0	0	0
Castors	C		0	0	0	0	0
Back in Stainless Steel	BS		0	0	0	0	0
Frame heater	FH		0	0	0	●	●
60Hz	60Hz		0	0	0	0	0

# 600 Snack remote



## General characteristics

- Interior constructed with AISI-304 stainless steel exterior in food grade stainless steel.
- 50 mm thickness, CFC-free, high-density (40 kg/m<sup>3</sup>) polyurethane insulation, injected under high pressure.
- Heavy-duty stainless-steel working top with 100mm high splash-back, preventing spillage behind the counter.
- Intuitive, digital display for electronic control with energy saving function to ensure an optimal control of storing products.
- Stainless steel doors with ergonomic, full-length, robust, perfectly integrated handle that avoids dust and dirt collection.
- Stainless steel drawers with perforated bottom plates and telescopic sliding guides, capable of complete retraction, to economize working surface. Other drawer configurations are also available upon request.
- Equipped without unit condenser
- Height-adjustable stainless steel legs. Height of the legs can be adjusted individually (130 mm - 200 mm) to enable convenient cleaning.
- Stamped edge interiors, easier cleaning operations to reduce potential dirt traps with a built-in drainage to get rid of waste liquid inside units
- Removable and height adjustable epoxy coated grids with a maximum loading capacity of up to 40 kg.
- Equipped with 1 grid 405x460 mm in each edge door and 1 grid 405x525 in centered doors and height adjustable 2 sets of tray slides per each full door.
- Electrical power supply: 220V-240V 1N.

## Technical data

	19089558	19089559	19089560	19089565	19089566
	CCP-2G/R	CCP-3G/R	CCP-4G/R	CCN-2G/R	CCN-3G/R
Energy Efficiency	-	-	-	-	-
Annual Consumption (kWh) (1)	-	-	-	-	-
Gas Type	(6)	(6)	(6)	(6)	(6)
Cooling Power (kW)	0,361 (1)	0,361 (1)	0,436 (1)	0,364 (2)	0,364 (2)
Defrost	STOP	STOP	STOP	ELECTRIC	ELECTRIC
Electric power (kW)	0,029	0,029	0,029	0,066	0,076
Gross Volume (L)	1192	1717	2242	1192	1717
Length (mm)	1192	1717	2242	1192	1717
Depth (mm)	600	600	600	600	600
Height (mm)	850	850	850	850	850

(1) Evap. -10°C/ Cond. 55°C      (2) Evap. -25°C/ Cond. 55°C      (6) Consult the manufacturer

## Standard Accessories

				2S	3S	4S
	19097777	EPOXY GRID SACK 405x460	pc	2	2	2
	19097775	EPOXY GRID SACK 405x525	pc	0	1	2



REFERENCE	DESCRIPTION	TEMPERATURE	FREQUENCY	DOOR (D)	DRAWER (H) 1/2 + 1/2	€
19089631	CCP-2S/R	0°C +8 °C	50/60	2	-	-
19089632	CCP-3S/R	0°C +8 °C	50/60	3	-	-
19089633	CCP-4S/R	0°C +8 °C	50/60	4	-	-
19089649	CCP-2S/R HD	0°C +8 °C	50/60	2	1	-
19089650	CCP-2S/R HH	0°C +8 °C	50/60	1	2	-
19089651	CCP-3S/R HDD	0°C +8 °C	50/60	-	3	-
19089653	CCP-3S/R HHD	0°C +8 °C	50/60	3	1	-
19089654	CCP-3S/R HHH	0°C +8 °C	50/60	2	2	-
19089655	CCP-4S/R HDDD	0°C +8 °C	50/60	1	3	-
19089656	CCP-4S/R HHDD	0°C +8 °C	50/60	-	4	-
19089657	CCP-4S/R HHHH	0°C +8 °C	50/60	2	-	-
19089658	CCP-4S/R HHHH	0°C +8 °C	50/60	3	-	-
19089638	CCN-2S/R	-18°C / -22°C	50/60	1	1	-
19089639	CCN-3S/R	-18°C / -22°C	50/60	-	2	-

## Options

			CCP-2S/R	CCP-3S/R	CCP-4S/R	CCN-2S/R	CCN-3S/R
Panoramic Opening	PO		0	0	0	0	0
No Top	NT		0	0	0	0	0
No Splash-back	NS		0	0	0	0	0
1/2 + 1/2 Drawer	H		0	0	0	-	-
1/3 + 1/3 + 1/3 Drawer	T_1_3		0	0	0	-	-
2/3 + 1/3 Drawer	W		0	0	0	-	-
UK Plug (G Type)	CI		0	0	0	0	0
Lock	LC		0	0	0	0	0
Back in Stainless Steel	BS		0	0	0	0	0
Frame heater	FH		0	0	0	●	●

# 600 Snack with Sinks



## General characteristics

- Interior constructed with AISI-304 stainless steel exterior in food grade stainless steel.
- 50 mm thickness, CFC-free, high-density (40 kg/m<sup>3</sup>) polyurethane insulation, injected under high pressure.
- Heavy-duty stainless-steel working top with 100mm high splash-back, preventing spillage behind the counter with 330x330x200 mm stamped bowl.
- Intuitive, digital display for electronic control with energy saving function to ensure an optimal control of storing products.
- Stainless steel doors with ergonomic, full-length, robust, perfectly integrated handle that avoids dust and dirt collection.
- Stainless steel drawers with perforated bottom plates and telescopic sliding guides, capable of complete retraction, to economize working surface. Other drawer configurations are also available upon request.
- Height-adjustable stainless steel legs. Height of the legs can be adjusted individually (130 mm - 200 mm) to enable convenient cleaning.
- Stamped edge interiors, easier cleaning operations to reduce potential dirt traps with a built-in drainage to get rid of waste liquid inside units
- Removable and height adjustable epoxy coated grids with a maximum loading capacity of up to 40 kg.
- Electrical power supply: 220V-240V 1N

## Technical data

REFERENCE	MODEL	FREQUENCY	TEMPERATURE	GAS	COOLING POWER (kW)	ELECTRIC POWER (kW)	DEFROST	GROSS VOLUME (L)	ANNUAL CONSUMPTION (kWh)	ENERGY EFFICIENCY CLASS	DIMENSIONS	€
19089662	CCP-2S/S	50Hz	0°C +8 °C	R-600a	0,361 (1)	0,203	STOP	268	836 (4)	C	1492 x 600 x 850	-
19089663	CCP-3S/S	50Hz	0°C +8 °C	R-600a	0,361 (1)	0,203	STOP	416	931 (4)	C	2017 x 600 x 850	-
19089664	CCP-4S/S	50Hz	0°C +8 °C	R-600a	0,436 (1)	0,224	STOP	564	1096 (4)	C	2542 x 600 x 850	-
19106964	CCN-2S/S	50Hz	-18°C -22°C	R-290	0,364 (2)	0,319	ELECTRIC	268	2120 (4)	D	1492 x 600 x 850	-
19106965	CCN-3S/S	50Hz	-18°C -22°C	R-290	0,364 (2)	0,329	ELECTRIC	416	2879 (4)	E	2017 x 600 x 850	-

(1)Evap. -10°C/ Cond. 45°C (2) Evap. -25°C / Cond. 45°C (4) According to EN22041 standard

## Options

			CCP-2S/S	CCP-3S/S	CCP-4S/S	CCN-2S/S	CCN-3S/S
Panoramic Opening	PO		0	0	0	0	0
Left Group	LG		0	0	0	0	0
No Splash-back	NS		0	0	0	0	0
1/2 + 1/2 Drawer	H		0	0	0	-	-
1/3 + 1/3 + 1/3 Drawer	T_1_3		0	0	0	-	-
1/3 + 2/3 Drawer	W		0	0	0	-	-
UK Plug (G Type)	CI		0	0	0	0	0

			CCP-2S/S	CCP-3S/S	CCP-4S/S	CCN-2S/S	CCN-3S/S
Lock	LC		0	0	0	0	0
Castors	C		0	0	0	0	0
Back in Stainless Steel	BS		0	0	0	0	0
Frame heater	FH		0	0	0	-	-
60Hz	60Hz		0	0	0	0	0

			2G	3G	4G	
	19097778	GN 1/1 EPOXY GRID	pc	2	3	4
	19014778	TRAY SUPPORT GUIDES L=562mm	pc	4	6	8

## Standard Accessories

# 600 Snack Display



## General characteristics

- Interior constructed with AISI-304 stainless steel exterior in food grade stainless steel.
- 50 mm thickness, CFC-free, high-density (40 kg/m<sup>3</sup>) polyurethane insulation, injected under high pressure.
- Heavy-duty stainless-steel working top with 100mm high splash-back, preventing spillage behind the counter.
- Intuitive, digital display for electronic control with energy saving function to ensure an optimal control of storing products.
- Double-glazed doors insulated with low thermal emissivity to reduce heat transfer with ergonomic handle.
- Height-adjustable stainless steel legs. Height of the legs can be adjusted individually (130 mm - 200 mm) to enable convenient cleaning.
- Stamped edge interiors, easier cleaning operations to reduce potential dirt traps with a built-in drainage to get rid of waste liquid inside units
- Removable and height adjustable epoxy coated grids with a maximum loading capacity of up to 40 kg.
- Electrical power supply: 220V-240V 1N

## Technical data

REFERENCE	MODEL	FREQUENCY	TEMPERATURE	GAS	COOLING POWER (kW)	ELECTRIC POWER (kW)	DEFROST	GROSS VOLUME (L)	ANNUAL CONSUMPTION (kWh)	ENERGY EFFICIENCY CLASS	DIMENSIONS	€
19089659	CCP-2S GD	50Hz	0°C +8 °C	R-600a	0,361 (1)	0,207	STOP	268	1379 (5)	C	1492 x 600 x 850	-
19089660	CCP-3S GD	50Hz	0°C +8 °C	R-600a	0,361 (1)	0,209	STOP	416	1536 (5)	C	2017 x 600 x 850	-
19089661	CCP-4S GD	50Hz	0°C +8 °C	R-600a	0,436 (1)	0,232	STOP	564	1808 (5)	D	2542 x 600 x 850	-

(1) Evap. -10°C/ Cond. 45°C (5) According to EN23953 standard

## Options

			CCP-2S GD	CCP-3S GD	CCP-4S GD
Panoramic Opening	PO		0	0	0
Left Group	LG		0	0	0
No Top	NT		0	0	0
No Splash-back	NS		0	0	0
UK Plug (G Type)	CI		0	0	0
Lock	LC		●	●	●
Castors	C		0	0	0
Back in Stainless Steel	BS		0	0	0

			CCP-2S GD	CCP-3S GD	CCP-4S GD
Frame heater	FH		0	0	0
60Hz	60Hz		0	0	0

			2G	3G	4G	
	19097778	GN 1/1 EPOXY GRID	pc	2	3	4
	19014778	TRAY SUPPORT GUIDES L=562mm		4	6	8

## Standard Accessories

# 800 Pastry EN60x40



## General characteristics

- Interior constructed with AISI-304 stainless steel exterior in food grade stainless steel.
- 50 mm thickness, CFC-free, high-density (40 kg/m<sup>3</sup>) polyurethane insulation, injected under high pressure.
- Heavy-duty stainless-steel working top with 100mm high splash-back, preventing spillage behind the counter.
- Intuitive, digital display for electronic control with energy saving function to ensure an optimal control of storing products.
- Stainless steel doors with ergonomic, full-length, robust, perfectly integrated handle that avoids dust and dirt collection.
- Height-adjustable stainless steel legs. Height of the legs can be adjusted

- individually (130 mm - 200 mm) to enable convenient cleaning.
- Stamped edge interiors, easier cleaning operations to reduce potential dirt traps with a built-in drainage to get rid of waste liquid inside units
- Removable and height adjustable epoxy coated EN60x40 grids with a maximum loading capacity of up to 40 kg.
- Equipment with 1 EN60x40 grids and height adjustable 2 sets of tray slides per each full door
- 2 Version of cooling system
  - Standard one forced air refrigeration equipment with evaporator.
  - GV version Static cooling equipment.
- Electrical power supply: 220V-240V 1N.

## Technical data

REFERENCE	MODEL	FREQUENCY	TEMPERATURE	GAS	COOLING POWER (kW)	ELECTRIC POWER (kW)	DEFROST	GROSS VOLUME (L)	ANNUAL CONSUMPTION (kWh)	ENERGY EFFICIENCY CLASS	DIMENSIONS	€
19102582	CCP-2B	50Hz	0°C +8 °C	R-290	0,369 (1)	0,262	STOP	325	1477 (4)	D	1492 x 800 x 850	-
19102583	CCP-3B	50Hz	0°C +8 °C	R-290	0,369 (1)	0,262	STOP	584	1723 (4)	D	2017 x 800 x 850	-
19102618	CCP-4B	50Hz	0°C +8 °C	R-290	0,593 (1)	0,387	STOP	792	2442 (4)	E	2542 x 800 x 850	-
19089665	CCP-2B GV	50Hz	0°C +8 °C	R-290	0,369 (1)	0,22	STOP	325	-	-	1492 x 800 x 850	-
19089666	CCP-3B GV	50Hz	0°C +8 °C	R-290	0,593 (1)	0,303	STOP	584	-	-	2017 x 800 x 850	-
19089667	CCP-4B GV	50Hz	0°C +8 °C	R-290	0,593 (1)	0,303	STOP	792	-	-	2542 x 800 x 850	-

(1) Evap. -10°C/ Cond. 55°C (4) According to EN22041 standard

## Options

			CCP-2B	CCP-3B	CCP-4B
Panoramic Opening	PO		0	0	0
Left Group	LG		0	0	0
No Top	NT		0	0	0
No Splash-back	NS		0	0	0
UK Plug (G Type)	CI		0	0	0
Lock	LC		0	0	0
Remote Group	RG		0	0	0
Granite Top	GR		0	0	0

			CCP-2G GD	CCP-3G GD	CCP-4G GD
Castors	C		0	0	0
Back in Stainless Steel	BS		0	0	0
Frame heater	FH		0	0	0
60Hz	60Hz		0	0	0

## Standard Accessories

			2G	3G	4G
	19097776	EN600x400 EPOXY GRID	2	3	4
	19033557	TRAY SUPPORT GUIDES L=649mm	4	6	8

# Accessories

PICTURE	MODEL	REFERENCE	DESCRIPTION	WHERE USED	€
<b>GRIDS</b>					
	EG-GN1/1	19097778	GN 1/1 EPOXY GRID	GN 1/1 COUNTERS	-
	EG-GN2/3	19106414	GN 2/3 EPOXY GRID	KORE 700 REFRIGERATED BASE	-
	EG-SNC1	19097775	EPOXY GRID SNACK 405x525	SNACK COUNTERS	-
	EG-SNC2	19097777	EPOXY GRID SNACK 405x460	SNACK COUNTERS	-
	EG-EN6040	19097776	EN600x400 EPOXY GRID	EN60x40 COUNTERS	-
<b>GRID SUPPORT KIT</b>					
	GSK-519	19015961	TRAY SUPPORT GUIDES L=519mm	ADVANCE GN 1/1 COUNTERS	-
	GSK-562	19014778	TRAY SUPPORT GUIDES L=562mm	CONCEPT GN 1/1 COUNTERS	-
	GSK-613	19010200	TRAY SUPPORT GUIDES L=613mm	CONCEPT CCPC MODELS	-
	GSK-649	19033557	TRAY SUPPORT GUIDES L=649mm	EN60x40 COUNTERS & KORE 900	-
	GSK-496	19033558	TRAY SUPPORT GUIDES L=496mm	KORE 700 REFRIGERATED BASE	-
<b>DOOR ORIENTATION KIT</b>					
	KDO-4-R	19098305	DOOR ORIENTATION KIT RIGHT	ALL COUNTERS	-
	KDO-4-L	19098304	DOOR ORIENTATION KIT LEFT	ALL COUNTERS	-
<b>CASTORS KIT</b>					
	KC-6 Ø80	19016846	CASTOR KIT 6 (3B + 3WB)	2 AND 3 BODY COUNTERS	-
	KC-6 Ø80	19011005	CASTOR KIT 6 (3B + 3WB)	4 BODY COUNTERS	-
<b>DRAWERS KIT</b>					
	KR-CA-1/2+1/2	19096243	KIT DRAWERS 1/2+1/2 GN	ADVANCE GN 1/1	-
	KR-CA-1/3+1/3+1/3	19096245	KIT DRAWERS 1/3+1/3+1/3 GN	ADVANCE GN 1/1	-
	KR-CA-1/3+2/3	19096244	KIT DRAWERS 1/3+2/3 GN	ADVANCE GN 1/1	-
	KR-CG-1/2+1/2	19010993	KIT DRAWERS 1/2+1/2	CONCEPT GN 1/1	-
	KR-CG-1/2+1/2 G	19015952	KIT DRAWERS 1/2+1/2 GROUP SIDE	CONCEPT GN 1/1	-
	KR-CG-1/2+1/2 LG	19036401	KIT DRAWERS 1/2+1/2 GROUP SIDE LG	CONCEPT GN 1/1	-
	KR-CG-1/3+1/3+1/3	19015954	KIT DRAWERS 1/3+1/3+1/3	CONCEPT GN 1/1	-
	KR-CG-1/3+2/3	19015953	KIT DRAWER 1/3+2/3	CONCEPT GN 1/1	-
	KR-CG-1/3+1/3	19072745	KIT DRAWERS (1/3+1/3)	GN 1/1 REFRIGERATED BASES	-
	KR-CS-1/2+1/2	19004925	KIT DRAWERS 1/2+1/2	SNACK	-
	KR-CS-1/2+1/2 G	19004921	KIT DRAWERS 1/2+1/2 GROUP SIDE	SNACK	-
	KR-CS-1/2+1/2 LG	19004930	KIT DRAWERS 1/2+1/2 GROUP SIDE LG	SNACK	-
	KR-CS-1/3+2/3	19004927	KIT DRAWER 1/3+2/3	SNACK	-
	KR-CS-1/3+1/3+1/3	19004923	KIT DRAWERS 1/3+1/3+1/3	SNACK	-





Special tables  
for specific tasks.



Access the website

# Preparation counters

— Features.....	<b>313</b>
— Configurable Pizza Counters ....	<b>315</b>
— Compact Pizza Counters.....	<b>318</b>
— Refrigerated work stations.....	<b>319</b>
— Saladettes .....	<b>322</b>
— Accessories .....	<b>325</b>

Special units or any variations from the standard model must be assembled at the factory at an additional charge over the standard model's price.

Please, contact Fagor Professional for any other variation or option that is not included on this list.

# Characteristics

## Wide range

Complete range of refrigerated preparation counters, constructed in 700 and 800mm depth with diverse worktop configurations (Stainless Steel, Granit, Polypropilene etc...).



## Multiflow

Optimal air circulation system that guarantees a balanced and constant distribution throughout the equipment, so that the temperature remains uniform. It helps preserve food for longer.



## Integrated handles

Stainless steel doors with ergonomic, full-length, robust, perfectly integrated handle that ensures practical opening of the drawers and avoids dust and dirt collection.



## ECO function

Function that optimizes the performance by automatically setting temperatures, when doors are not opened so that the cooling unit works only when needed and always, efficiently.



## Removable door gasket

Removable triple camera pull-out/push-in magnetic door gasket to keep maximum hygiene and maintain the insulating properties.



## Electronic control Easy to use

Functional and intuitive electronic control with capacitive keyboard that allows direct access to main functions



## Maximum stability

Height-adjustable stainless steel legs as standard. Height of the legs can be adjusted individually. In addition, there is also the option to choose swivel wheels or legs for marine.

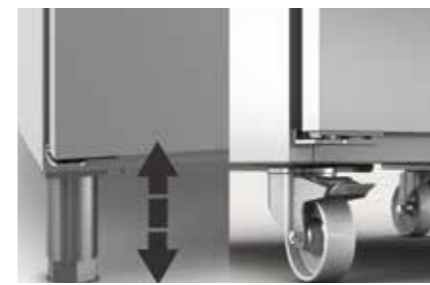

## Telescopic sliding drawers

Stainless steel drawers with perforated bottom plates and telescopic sliding guides, capable of complete retraction, to economize working surface.



## Guide and zippers system

Removable Stainless steel rack and guide system without use of tools which allows a proper distribution of products.





CONFIGURABLE PIZZA COUNTERS

# 700 GN 1/1



### General characteristics

- Specially manufactured in high-quality stainless-steel for intensive professional applications, featuring a very robust design and perfect finishing. Ideal to be used as a pizza preparation station when combined with pizza ingredient cases.
- 50 mm thickness, CFC-free, high-density (40 kg/m<sup>3</sup>) polyurethane insulation, injected under high pressure.
- Heavy-duty 30mm granite working top with side and rear splash-back of 160mm high, preventing spillage behind the counter.

- Stamped edge interiors, easier cleaning operations to reduce potential dirt traps with a built-in drainage to get rid of waste liquid inside units
- Removable and height adjustable epoxy coated GN 1/1 grids with a maximum loading capacity of up to 40 kg.
- Equipment with 1 GN 1/1 grids and height adjustable 2 sets of tray slides per each full door
- Electrical power supply: 220V-240V 1N.

### Technical data

REFERENCE	MODEL	FREQUENCY	TEMPERATURE	GAS	COOLING POWER (kW)	ELECTRIC POWER (kW)	DEFROST	GROSS VOLUME (L)	ANNUAL CONSUMPTION (kWh)	ENERGY EFFICIENCY CLASS	DIMENSIONS (MM)	€
19089668	CCP-2G	50Hz	0°C +8 °C	R-600a	0,361 (1)	0,203	STOP	274	956 (4)	B	1342 x 700 x 850	-
19089669	CCP-3G	50Hz	0°C +8 °C	R-600a	0,361 (1)	0,203	STOP	428	1095 (4)	C	1792 x 700 x 850	-
19089670	CCP-4G	50Hz	0°C +8 °C	R-600a	0,436 (1)	0,224	STOP	581	1245 (4)	C	2242 x 700 x 850	-

(1) Evap. -10°C/ Cond. 45°C (4) According to En22041 standard

### Options

			CCP-2G	CCP-3G	CCP-4G
Panoramic Opening	PO		O	O	O
Left Group	LG		O	O	O
1/2 + 1/2 Drawer	H		O	O	O
1/3 + 1/3 + 1/3 Drawer	T_1_3		O	O	O
1/3 + 2/3 Drawer	W		O	O	O
UK Plug (G Type)	CI		O	O	O
Lock	LC		O	O	O
Granite Top	GR		●	●	●

			CCP-2G	CCP-3G	CCP-4G
Back in Stainless Steel	BS		O	O	O
Frame heater	FH		O	O	O
60Hz	60Hz		O	O	O

### Standard Accessories

				2G	3G	4G
	19097778	GN 1/1 EPOXY GRID	pc	2	3	4
	19014778	TRAY SUPPORT GUIDES L=562mm	pc	4	6	8

CONFIGURABLE PIZZA COUNTERS

# 800 EN60x40



### General characteristics

- Specially manufactured in high-quality stainless-steel for intensive professional applications, featuring a very robust design and perfect finishing. Ideal to be used as a pizza preparation station when combined with pizza ingredient cases.
- 50 mm thickness, CFC-free, high-density (40 kg/m<sup>3</sup>) polyurethane insulation, injected under high pressure.
- Heavy-duty 30mm granite working top with side and rear splash-back of 160mm high, preventing spillage behind the counter.
- Neutral compartment with drawers which incorporate euronorm size,

- sanitary PVC made baskets. Drawers are assembled over telescopic sliding guides, capable of complete retraction, to maximize storage capacity.
- Stamped edge interiors, easier cleaning operations to reduce potential dirt traps with a built-in drainage to get rid of waste liquid inside units
- Removable and height adjustable epoxy coated EN60x40 grids with a maximum loading capacity of up to 40 kg.
- Equipment with 1 EN60x40 grids and height adjustable 2 sets of tray slides per each full door
- Electrical power supply: 220V-240V 1N.

### Technical data

REFERENCE	MODEL	FREQUENCY	TEMPERATURE	GAS	COOLING POWER (kW)	ELECTRIC POWER (kW)	DEFROST	GROSS VOLUME (L)	ANNUAL CONSUMPTION (kWh)	ENERGY EFFICIENCY CLASS	DIMENSIONS	€
19102651	CCP-2B	50Hz	0°C +8 °C	R-290	0,369 (1)	0,262	STOP	325	1478 (4)	D	1492 x 800 x 850	-
19102652	CCP-3B	50Hz	0°C +8 °C	R-290	0,369 (1)	0,262	STOP	584	1723 (4)	D	2017 x 800 x 850	-
19102653	CCP-4B	50Hz	0°C +8 °C	R-290	0,593 (1)	0,387	STOP	792	2442 (4)	E	2542 x 800 x 850	-
19102754	CCP-2B GR D7	50Hz	0°C +8 °C	R-290	0,369 (1)	0,262	STOP	325	1478 (4)	D	2017 x 800 x 850	-
19102782	CCP-3B GR D7	50Hz	0°C +8 °C	R-290	0,369 (1)	0,262	STOP	584	1723 (4)	D	2542 x 800 x 850	-
19102722	CCP-2B GR D4	50Hz	0°C +8 °C	R-290	0,369 (1)	0,262	STOP	325	1478 (4)	D	2017 x 800 x 850	-
19102759	CCP-3B GR D4	50Hz	0°C +8 °C	R-290	0,369 (1)	0,262	STOP	584	1723 (4)	D	2542 x 800 x 850	-

(1) Evap. -10°C/ Cond. 45°C (4) According to En22041 standard

### Options

			CCP-2B GR	CCP-3B GR	CCP-4B GR
Panoramic opening	PO		O	O	O
G Type Plug	CI		O	O	O
Lock	LC		O	O	O
Remote Group	RG		O	O	O
Back in Stainless Steel	BS		O	O	O
Frame heater	FH		O	O	O
60Hz	60Hz		O	O	O

			CCP-2B GR	CCP-3B GR	CCP-4B GR
Frame heater	FH		O	O	O
60Hz	60Hz		O	O	O

### Standard Accessories

				2B	3B	4B
	19097776	EN600x400 EPOXY GRID	pc	2	3	4
	19033557	TRAY SUPPORT GUIDES L=649mm	pc	4	6	8

## REFRIGERATED WORK STATION

## Ingredient Vitrines



## General characteristics

- Specially manufactured in high-quality stainless-steel for intensive professional applications, featuring a very robust design and perfect finishing. Ideal as a container ingredient for pizzas, salads, and sandwiches.
- CFC-free, high-density (40 kg/m<sup>3</sup>) polyurethane insulation, injected under high pressure.
- Intuitive digital control allows temperature parameters to be adjusted easily and quickly.

- Two versions available:
  - Exterior constructed with tempered glass and anodized aluminum profiles.
  - Stainless steel hinged lid with operating position at 90°C
- Designed in a wide variety of length, so as to fit with all configurable pizza counters options.
- Static cooling system. Cold is generated through a copper coil located on the bottom plate of the vitrin.
- Water drain especially designed to make cleaning operations quicker and easier, optimum for hygiene.
- Electrical power supply: 220V-240V 1N

## Technical data

REFERENCE	MODEL	FREQUENCY	TEMPERATURE	GAS	GROSS VOLUME (L)	ANNUAL CONSUMPTION (kWh)	DIMENSIONS (MM)	WHERE USED	€	
STOCK	19089671	SP-2G	50Hz	+2°C +8°C	R-600a	0,169 (1)	0,102	1340 x 336 x 450	CCP-2G GR	-
STOCK	19089672	SP-3G	50Hz	+2°C +8°C	R-600a	0,169 (1)	0,102	1790 x 336 x 450	CCP-3G GR	-
	19089673	SP-4G	50Hz	+2°C +8°C	R-600a	0,169 (1)	0,102	2240 x 336 x 450	CCP-4G GR	-
	19089674	SP-2B	50Hz	+2°C +8°C	R-600a	0,169 (1)	0,102	1496 x 336 x 450	CCP-2B GR	-
	19089675	SP-3B	50Hz	+2°C +8°C	R-600a	0,169 (1)	0,102	2019 x 336 x 450	CCP-3B GR + CCP-2B GRV D4 & D7	-
	19096958	SP-4B	50Hz	+2°C +8°C	R-600a	0,361 (1)	0,169	2542 x 336 x 450	CCP-4B GR + CCP-3B GR D4 & D7	-
	19096956	SP-2B GN 1/3	50Hz	+2°C +8°C	R-600a	0,169 (1)	0,102	1492 x 396 x 450	CCP-2B GR	-
	19096957	SP-3B GN 1/3	50Hz	+2°C +8°C	R-600a	0,169 (1)	0,102	2017 x 396 x 450	CCP-3B GR + CCP-2B GR D4 & D7	-
	19096959	SP-4B GN 1/3	50Hz	+2°C +8°C	R-600a	0,361 (1)	0,169	2542 x 396 x 450	CCP-4B GR + CCP-3B GR D4 & D7	-
STOCK	19089676	SPT-2G	50Hz	+2°C +8°C	R-600a	0,169 (1)	0,102	1340 x 336 x 250	CCP-2G GR	-
STOCK	19089677	SPT-3G	50Hz	+2°C +8°C	R-600a	0,169 (1)	0,102	1790 x 336 x 250	CCP-3G GR	-
	19089678	SPT-4G	50Hz	+2°C +8°C	R-600a	0,169 (1)	0,102	2240 x 336 x 250	CCP-4G GR	-
	19089679	SPT-2B	50Hz	+2°C +8°C	R-600a	0,169 (1)	0,102	1496 x 336 x 250	CCP-2B GR	-
	19089680	SPT-3B	50Hz	+2°C +8°C	R-600a	0,169 (1)	0,102	2019 x 336 x 250	CCP-3B GR + CCP-2B GRV D4 & D7	-
	19096982	SPT-4B	50Hz	+2°C +8°C	R-600a	0,361 (1)	0,169	2542 x 336 x 450	CCP-4B GR + CCP-3B GR D4 & D7	-
	19096980	SPT-2B GN 1/3	50Hz	+2°C +8°C	R-600a	0,169 (1)	0,102	1492 x 396 x 450	CCP-2B GR	-
	19096981	SPT-3B GN 1/3	50Hz	+2°C +8°C	R-600a	0,169 (1)	0,102	2017 x 396 x 450	CCP-3B GR + CCP-2B GR D4 & D7	-
	19096983	SPT-4B GN 1/3	50Hz	+2°C +8°C	R-600a	0,361 (1)	0,169	2542 x 396 x 450	CCP-4B GR + CCP-3B GR D4 & D7	-

(1) Evap. -10°C/ Cond. 45°C

## Options

		2G	3G	4G	2B	3B	4B
G Type Plug	Cl	0	0	0	0	0	0
60Hz	60Hz	0	0	0	0	0	0

## Compact Pizza Counters



## Características generales

- Specially manufactured in high-quality stainless-steel for intensive professional applications, featuring a very robust design and perfect finishing. Ideal to be used as a pizza preparation counter
- 50 mm thickness, CFC-free, high-density (40 kg/m<sup>3</sup>) polyurethane insulation, injected under high pressure.
- Heavy-duty 30mm granite working top with 88mm height splashback and a cutout to place 100 mm GN 1/6 bowls. 6 in CPZC-2G and 11 in CPZC-3G.
- Worktop ingredients vitrines are refrigerated by the air circulation of the cooling unit. Location of evaporator in the middle beam

- and the correct isolation of the worktop ensures an uniform cold distribution.
- Additional neutral compartment with 3 drawers EN 60x40 size.
- Stamped edge interiors, easier cleaning operations to reduce potential dirt traps with a built-in drainage to get rid of waste liquid inside units
- Removable and height adjustable epoxy coated EN60x40 grids with a maximum loading capacity of up to 40 kg.
- Equipment with 1 EN60x40 grids and height adjustable 2 sets of tray slides per each full door
- Electrical power supply: 220V-240V 1N.

## Technical data

REFERENCE	MODEL	FREQUENCY	TEMPERATURE	GAS	COOLING POWER (kW)	ELECTRIC POWER (kW)	DEFROST	GROSS VOLUME (L)	DIMENSIONS	€	
STOCK	19089681	CPZC-2G	50Hz	+0°C +8°C	R-290	0,369 (1)	0,262	STOP	325	1590 x 700 x 880	-
STOCK	19089682	CPZC-3G	50Hz	+0°C +8°C	R-290	0,369 (1)	0,262	STOP	480	2110 x 700 x 880	-

(1) Evap. -10°C/ Cond. 45°C

## Options

			CCP-2B GR	CCP-3B GR
Panoramic Opening	PO		0	0
UK Plug (G Type)	Cl		0	0
Lock	LC		0	0
Remote Group	RG		0	0
Granite Top	GR		●	●
Back in Stainless Steel	BS		0	0
Frame heater	FH		0	0
60Hz	60Hz		0	0

## Standard Accessories

			2B	3B	4B	
	19097776	EN600x400 EPOXY GRID	pc	2	3	4
	19014778	TRAY SUPPORT GUIDES L=562mm	pc	4	6	8



## REFRIGERATED WORK STATION

## 700 GN 1/1 for Pizza



## General characteristics

- Specially manufactured in high-quality stainless-steel for intensive professional applications, featuring a very robust design and perfect finishing. Ideal as a container ingredient for pizzas, salads, and sandwiches.
- 50 mm thickness, CFC-free, high-density (40 kg/m<sup>3</sup>) polyurethane insulation, injected under high pressure.
- Heavy-duty stainless-steel 50mm working top with Built-in neutral unit designed to house 8 or 10 containers GN ¼ or GN-1/3 of maximum 100mm depth (not included).
- Stainless steel hinged lid with opening position at 90°.

- Worktop ingredients bowls are refrigerated by the air circulation of the cooling unit. Location of evaporator in the middle beam and the correct isolation of the worktop ensures an uniform cold distribution.
- Stamped edge interiors, easier cleaning operations to reduce potential dirt traps with a built-in drainage to get rid of waste liquid inside units
- Removable and height adjustable epoxy coated GN 1/1 grids with a maximum loading capacity of up to 40 kg.
- Equipment with 1 GN 1/1 grids and height adjustable 2 sets of tray slides per each full door
- Electrical power supply: 220V-240V 1N

## Technical data

REFERENCE	MODEL	FREQUENCY	T*	GAS	COOLING POWER (kW)	ELECTRIC POWER (kW)	DEFROST	VOLUME (L)	DIMENSIONS (MM)	€
19089683	CPZ-2G GN1/3	50Hz	+0°C +8°C	R-290	0,369 (1)	0,262	STOP	290	1350 x 700 x 850	-
19089685	CPZ-3G GN1/3	50Hz	+0°C +8°C	R-290	0,796 (1)	0,522	STOP	445	1800 x 700 x 850	-
19096514	CPZ-2G GN1/4	50Hz	+0°C +8°C	R-290	0,369 (1)	0,262	STOP	290	1350 x 700 x 850	-
19096515	CPZ-3G GN1/4	50Hz	+0°C +8°C	R-290	0,796 (1)	0,522	STOP	445	1800 x 700 x 850	-

## Options

			CCP-2G	CCP-3G
Panoramic Opening	PO		0	0
1/2 + 1/2 Drawer	H		0	0
1/3 + 1/3 + 1/3 Drawer	T_1_3		0	0
UK Plug (G Type)	CI		0	0
Lock	LC		0	0
Remote Group	RG		0	0
Castors	C		0	0
Back in Stainless Steel	BS		0	0

(1) Evap. -10°C/ Cond. 45°C

## Standard Accessories

		2G	3G
	19097778 GN 1/1 EPOXY GRID	2	3
	19014778 TRAY SUPPORT GUIDES L=562mm	4	6

## REFRIGERATED WORK STATION

## 800 EN60x40 for Pizza



## General characteristics

- Specially manufactured in high-quality stainless-steel for intensive professional applications, featuring a very robust design and perfect finishing. Ideal as a container ingredient for pizzas.
- 50 mm thickness, CFC-free, high-density (40 kg/m<sup>3</sup>) polyurethane insulation, injected under high pressure.
- Heavy-duty stainless-steel 50mm working top with Built-in neutral unit designed to house 8 or 10 containers GN ¼ or GN-1/3 of maximum 100mm depth (not included).
- Stainless steel hinged lid with opening position at 90°.
- Worktop ingredients vitrines are refrigerated by the air circulation

of the cooling unit. Location of evaporator in the middle beam and the correct isolation of the worktop ensures an uniform cold distribution.

- Stamped edge interiors, easier cleaning operations to reduce potential dirt traps with a built-in drainage to get rid of waste liquid inside units
- Removable and height adjustable epoxy coated EN60x40 grids with a maximum loading capacity of up to 40 kg.
- Equipment with 1 EN60x40 grids and height adjustable 2 sets of tray slides per each full door
- Electrical power supply: 220V-240V 1N

## Technical data

REFERENCE	MODEL	FREQUENCY	TEMPERATURE	GAS	COOLING POWER (kW)	ELECTRIC POWER (kW)	DEFROST	GROSS VOLUME (L)	DIMENSIONS	€
19102515	CPZ-2B GN 1/3	50Hz	+0°C +8°C	R-290	0,369 (1)	0,262	STOP	470	1495 x 800 x 1055	-
19102518	CPZ-2B GN 1/4	50Hz	+0°C +8°C	R-290	0,369 (1)	0,262	STOP	685	1495 x 800 x 1055	-
19102562	CPZ-3B GN 1/3	50Hz	+0°C +8°C	R-290	0,796 (1)	0,522	STOP	470	1495 x 800 x 1055	-
19102565	CPZ-3B GN 1/4	50Hz	+0°C +8°C	R-290	0,796 (1)	0,522	STOP	685	1495 x 800 x 1055	-

(1) Evap. -10°C/ Cond. 45°C

## Options

			CCP-2B GR	CCP-3B GR
Panoramic Opening	PO		0	0
UK Plug (G Type)	CI		0	0
Lock	LC		0	0
Remote Group	RG		0	0
Castors	C		0	0
Back in Stainless Steel	BS		0	0
Frame heater	FH		0	0
60Hz	60Hz		0	0

## Standard Accessories

		2B	3B
	19097778 GN 1/1 EPOXY GRID	2	3
	19033557 TRAY SUPPORT GUIDES L=649mm	4	6

## REFRIGERATED WORK STATION

## 700 GN 1/1 for Salads



## General characteristics

- Specially manufactured in high-quality stainless-steel for intensive professional applications, featuring a very robust design and perfect finishing.
- 50 mm thickness, CFC-free, high-density (40 kg/m<sup>3</sup>) polyurethane insulation, injected under high pressure.
- Heavy-duty stainless-steel 50mm working top with open surface prepared to hold different configuration of 100mm depth GN containers.
- Stainless steel hinged lid with opening position at 90°.
- Worktop ingredients bowls are refrigerated by the air circulation

- of the cooling unit. Location of evaporator in the middle beam and the correct isolation of the worktop ensures an uniform cold distribution.
- Stamped edge interiors, easier cleaning operations to reduce potential dirt traps with a built-in drainage to get rid of waste liquid inside units
- Removable and height adjustable epoxy coated GN 1/1 grids with a maximum loading capacity of up to 40 kg.
- Equipment with 1 GN 1/1 grids and height adjustable 2 sets of tray slides per each full door.
- Electrical power supply: 220V-240V 1N

## Technical data

REFERENCE	MODEL	FREQUENCY	TEMPERATURE	GAS	COOLING POWER (kW)	ELECTRIC POWER (kW)	DEFROST	GROSS VOLUME (L)	DIMENSIONS (MM)	€
19089687	CPS-2G	50Hz	+0°C +8°C	R-290	0,369 (1)	0,28	STOP	209	1342 x 700 x 850	-
19089689	CPS-3G	50Hz	+0°C +8°C	R-290	0,593 (1)	0,414	STOP	313	1792 x 700 x 850	-

(1) Evap. -10°C/ Cond. 45°C

## Options

			CPZ-3B	CPS-2G
Panoramic Opening	PO		0	0
UK Plug (G Type)	CI		0	0
Lock	LC		0	0
Castors	C		0	0
Back in Stainless Steel	BS		0	0
60Hz	60Hz		0	0

## Standard Accessories

			2G	3G
	19097778	GN 1/1 EPOXY GRID	2	3
	19014778	TRAY SUPPORT GUIDES L=562 mm	4	6

## Saladettes

## General characteristics

- Specially manufactured in high-quality stainless-steel for intensive professional applications, featuring a very robust design and perfect finishing. Ideal to be used as a pizza preparation station when combined with pizza ingredient cases.
- 50 mm thickness, CFC-free, high-density (40 kg/m<sup>3</sup>) polyurethane insulation, injected under high pressure.
- Heavy-duty 30mm granite working top with side and rear splash-back of 160mm high, preventing spillage behind the counter.
- Neutral compartment with drawers which incorporate euronorm size, sanitary PVC made baskets. Drawers are assembled over telescopic

- slidding guides, capable of complete retraction, to maximize storage capacity.
- Stamped edge interiors, easier cleaning operations to reduce potential dirt traps with a built-in drainage to get rid of waste liquid inside units
- Removable and height adjustable epoxy coated EN60x40 grids with a maximum loading capacity of up to 40 kg.
- Equipment with 1 EN60x40 grids and height adjustable 2 sets of tray slides per each full door.
- Electrical power supply: 220V-240V 1N.

## Options

			RPS-2G	RPS-3G
Panoramic Opening	PO		●	●
1/2 + 1/2 Drawer	H		0	0
UK Plug (G Type)	CI		0	0
Remote Group	RG		0	0
60Hz	60Hz		0	0

## Standard Accessories

			2G	3G
	19104363	GN 1/1 EPOXY GRID FOR SALADETTE	2	3
	19014778	TRAY SUPPORT GUIDES L=562 mm	2	3

## Solid worktop saladettes



- 30 mm CFC free polyurethane injected stainless Steel worktop without splashback.

## Technical data

REFERENCE	MODEL	FREQUENCY	TEMPERATURE	GAS	COOLING POWER (kW)	ELECTRIC POWER (kW)	DEFROST	GROSS VOLUME (L)	ANNUAL CONSUMPTION (kWh)	ENERGY EFFICIENCY CLASS	DIMENSIONS	€
19105458	RPS-2G NS	50Hz	+0°C +8°C	R-290	0,369 (1)	0,245	STOP	209	1403 (4)	D	894 x 700 x 850	-
19105459	RPS-3G NS	50Hz	+0°C +8°C	R-290	0,369 (1)	0,267	STOP	313	1608 (4)	D	1358 x 700 x 850	-

(1) Evap. -10°C/ Cond. 45°C (4) According to En22041 standard

## Polyethylene worktop saladettes



- Open worktop suitable for GN container and removable high density polyethylene worktop surface suitable for handling food.  
Tilting lid with opening fix position.

\* GN containers not included as standard  
\* GN containers configuration available on accessories page (225).

### Technical data

MODEL	FREQUENCY	TEMPERATURE	GAS	COOLING POWER (kW)	ELECTRIC POWER (kW)	DEFROST	GROSS VOLUME (L)	DIMENSIONS (MM)	€	
19105614	RPS-2GP	50Hz	+0°C+8°C	R-290	0,369 (1)	0,245	STOP	209	894 x 700 x 861	-
19105067	RPS-3GP	50Hz	+0°C+8°C	R-290	0,369 (1)	0,267	STOP	313	1358 x 700 x 861	-

## Pizza worktop saladettes



- 30 mm CFC free polyurethane injected stainless Steel worktop with open area for GN 1/6 containers.

\* GN containers not included as standard

### Technical data

REFERENCE	MODEL	FREQUENCY	TEMPERATURE	GAS	COOLING POWER (kW)	ELECTRIC POWER (kW)	DEFROST	GROSS VOLUME (L)	DIMENSIONS (MM)	€
19105615	RPS-2GZ	50Hz	+0°C+8°C	R-290	0,369 (1)	0,245	STOP	209	894 x 700 x 955	-
19105611	RPS-3GZ	50Hz	+0°C+8°C	R-290	0,369 (1)	0,267	STOP	313	1358 x 700 x 955	-

(1) Evap. -10°C/ Cond. 45°C

## Sandwich worktop saladettes



- Heavy duty 30mm Granit built worktop with an open space suitable for GN 1/6 containers

\* GN containers not included as standard

### Technical data

REFERENCE	MODEL	FREQUENCY	TEMPERATURE	GAS	COOLING POWER (kW)	ELECTRIC POWER (kW)	DEFROST	GROSS VOLUME (L)	DIMENSIONS (MM)	€
19105616	RPS-2GS	50Hz	+0°C+8°C	R-290	0,369 (1)	0,245	STOP	209	894 x 700 x 1140	-
19105617	RPS-3GS	50Hz	+0°C+8°C	R-290	0,369 (1)	0,267	STOP	313	1358 x 700 x 1140	-

## Compact pizza saladettes



- Heavy-duty 30mm granite working top with side splash-back with 160 mm height.

- Available to fit GV- range ingredient vitrines range. Compatible models:





- GV-135 5 x GN 1/4
- GVL-135, 5 x GN 1/4







### Technical data

REFERENCE	MODEL	FREQUENCY	TEMPERATURE	GAS	COOLING POWER (kW)	ELECTRIC POWER (kW)	DEFROST	GROSS VOLUME (L)	DIMENSIONS (MM)	€
19104297	RPS-2G GR D6	50Hz	+0°C+8°C	R-290	0,369 (1)	0,245	STOP	209	1358 x 700 x 1010	-
19105613	RPS-3G GR	50Hz	+0°C+8°C	R-290	0,369 (1)	0,267	STOP	313	1358 x 700 x 1010	-

(1) Evap. -10°C/ Cond. 45°C

# Accessories

PICTURE	MODEL	REFERENCE	DESCRIPTION	CAPACITY (L)	WHERE USED	€
<b>GRIDS</b>						
	EG-GN1/1	19097778	GN1/1 EPOXY GRID	-	GN 1/1 PREPARATION COUNTERS	-
	EG-EN6040	19097776	EN600x400 EPOXY GRID	-	800 COUNTERS + COMPACT PIZZA COUNTERS	-
	EGS-GN1/1	19104363	GN1/1 EPOXY GRID FOR SALADETTE	-	SALADETTES	-
<b>GRID SUPPORT KIT</b>						
	GSK-562	19014778	TRAY SUPPORT GUIDES L=562mm	-	700 COUNTERS + SALADETTES	-
	GSK-649	19033557	TRAY SUPPORT GUIDES L=649mm	-	800 COUNTERS	-
<b>DOOR ORIENTATION KIT</b>						
	KDO-4-R	19098305	DOOR ORIENTATION KIT RIGHT	-	ALL COUNTERS	-
	KDO-4-L	19098304	DOOR ORIENTATION KIT LEFT	-	ALL COUNTERS	-
<b>GN BOWLS</b>						
	GN-1/6-65	19104382	GN1/6 65 mm DEPTH BOWL	1,0	SALADETTES	-
	GN-1/6-100	19104383	GN1/6 100 mm DEPTH BOWL	1,6	SALADETTES	-
	GN-1/4-40	19104384	GN1/4 40 mm DEPTH BOWL	1,0	SALADETTES	-
	GN-1/4-65	19104385	GN1/4 65 mm DEPTH BOWL	1,8	SALADETTES	-
	GN-1/4-100	19104386	GN1/4 100 mm DEPTH BOWL	2,8	SALADETTES	-
	GN-1/4-150	19106427	GN 1/4 150mm DEPTH BOWL	1,5	INGREDIENT VITRINES	-
	GN-1/3-40	19104387	GN1/3 40 mm DEPTH BOWL	2,5	SALADETTES	-
	GN-1/3-65	19104388	GN1/3 65 mm DEPTH BOWL	4,0	SALADETTES	-
	GN-1/3-100	19104389	GN1/3 100 mm DEPTH BOWL	2,5	SALADETTES	-
	GN-1/3-150	19106426	GN 1/3 150mm DEPTH BOWL	4,0	INGREDIENT VITRINES	-
	GN-1/2-40	19104390	GN1/2 40 mm DEPTH BOWL	6,5	SALADETTES	-
	GN-1/2-65	19104391	GN1/2 65 mm DEPTH BOWL	5,5	SALADETTES	-
	GN-1/2-100	19104392	GN1/2 100 mm DEPTH BOWL	9,0	SALADETTES	-
	GN-1/1-40	19048493	GN1/1 40 mm DEPTH BOWL	14,0	SALADETTES	-
	GN-1/1-65	19048494	GN1/1 65 mm DEPTH BOWL	5,7	SALADETTES	-
	GN-1/1-100	19048495	GN1/1 100 mm DEPTH BOWL	4,0	SALADETTES	-
<b>KIT SUPPORTS FOR GN BOWLS</b>						
	KG1/6S9	19104364	KIT SUPPORT FOR GN1/6 BOWLS		RPS-2GP	-
	KG1/3S9	19104365	KIT SUPPORT FOR GN1/3 + GN1/6 BOWLS		RPS-2GP	-
	KG1/6S14	19104366	KIT SUPPORT FOR GN1/6 BOWLS		RPS-3GP	-
	KG1/4S14	19104367	KIT SUPPORT FOR GN1/4 BOWLS		RPS-3GP	-
	KG1/3S14	19104368	KIT SUPPORT FOR GN1/3 BOWLS		RPS-3GP	-
	KG1/2S14	19104369	KIT SUPPORT FOR GN1/2 BOWLS		RPS-3GP	-

PICTURE	MODEL	REFERENCE	DESCRIPTION	WHERE USED	€
<b>DRAWERS KIT</b>					
	KR-CG-1/2+1/2	19010993	KIT DRAWERS 1/2+1/2	GN 1/1 PREPARATION COUNTERS	-
	KR-CG-1/2+1/2 G	19015952	KIT DRAWERS 1/2+1/2 GROUP SIDE	GN 1/1 PREPARATION COUNTERS	-
	KR-CG-1/2+1/2 LG	19036401	KIT DRAWERS 1/2+1/2 GROUP SIDE LG	GN 1/1 PREPARATION COUNTERS	-
	KR-CG-1/3+1/3+1/3	19015954	KIT DRAWERS 1/3+1/3+1/3	GN 1/1 PREPARATION COUNTERS	-
	KR-CG-1/3+2/3	19015953	KIT DRAWER 1/3+2/3	GN 1/1 PREPARATION COUNTERS	-
	KR-SA-1/2+1/2	19106089	KIT DRAWERS 1/2+1/2 SALADETTES	SALADETTES	-



# Blast chillers

- Why use a blast chiller?..... **329**
- Features ..... **331**
- Advance Blast chillers..... **333**
- Concept Blast chillers ..... **334**
- COOK&CHILL Blast chillers..... **335**
- Roll-in Blast chillers..... **336**



Safe, effective and respectful chilling with your food.

# Blast chillers

## Why use a blast chiller?

### 1. Hygiene and safety

All fresh organic food products contain a natural bacterial load which, in favourable ambient conditions (temperature and humidity), multiplies producing hazardous effects on consumer health.

Between +65°C and +3°C: in this temperature range, bacterial multiplication is accelerated exponentially.

Blast chilling means lowering the temperature of the product from +90°C to +3°C in less than 90 minutes. Passing through the critical temperature range between so fast where effects of harmful bacteria are disabled.

Blast chilling cooked product not only prevents bacterial proliferation but also prolongs product conservation time, avoiding loss of flavor and aroma.

The quality of the food is not affected, enlarging product storing time.

### 2. Work streamlining

Blast chillers allow a large quantity of product to be prepared and, once blast chilled, it can be consumed within a period of 5-7 day, while frozen product duration can extend to several months, maintaining organoleptic condition of the food.

The preservation of product quality, allows advance planning of kitchen work, improving raw ingredients purchase, as well as work load with advantages in terms of hygiene and menu variety.

### 3. Time savings

The advance preparation of foods and blast chilling of them allows kitchens to offer a more delicious and varied menu when required. The chef does not have to constantly oversee the process of preparing several dishes.

The simple operation of reheating the food allows a wide range of dishes to be served within a short period of time.

Blast chillers increase production capacity, thereby reducing staff costs and providing outstanding advantages in terms of profitability and time.

### 4. Quality

The rapid reduction in temperature makes it possible to conserve food moisture content and prevent normal bacterial proliferation.

Fast freezing encourages the formation of intercellular microcrystals (figure 2), which maintain the compactability, flavour and freshness characteristics of foods over time.

Asber blast chillers are also exceptional at preserving fresh and raw foods, such as fish, crustaceans, vegetables, bread and partially-finished products such as fresh pasta and sauces.

### 5. Applications

This kitchen work streamlining system is highly advantageous for all types of catering and especially for canteens, hospitals and restaurants, as well as for special occasions such as large banquets.

It also allows to all kind of restaurants and catering business to offer their well-presented dishes which are ready to eat.

### 6. Other advantages

Blast chillers optimize stock management by:

- Reductions in lost weight due to the natural evaporation of moisture from cooked food
- Planned food purchases, thereby improving kitchen stock organisation
- Organization of storage capacities and work load, adjusting capable personal attention
- Drastic reductions in waste and unused food

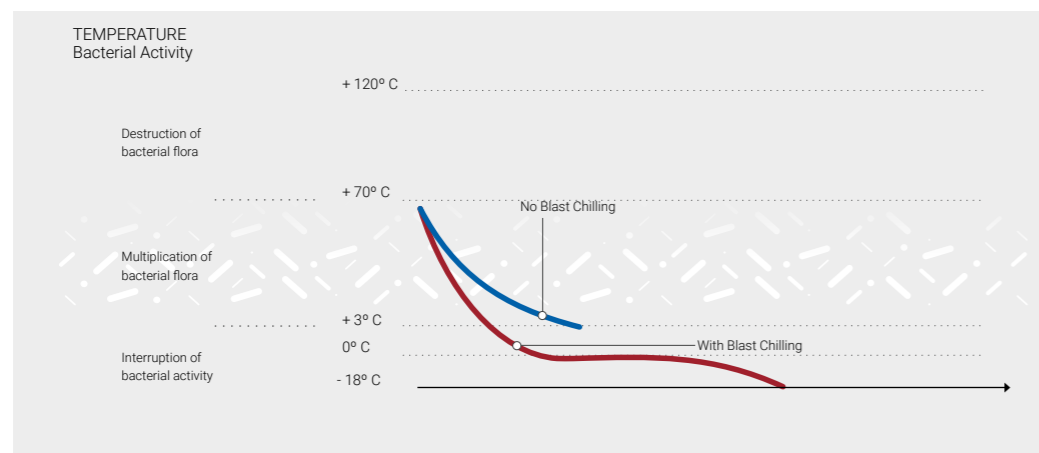

### Blast chilling

**SOFT CYCLE (STANDARD) - 90'**  
The right cycle for small size, light, fine food.

**STRONG CYCLE (INTENSIVE) - 90'**  
Recommended for high density or large size food, as well as for packed food.

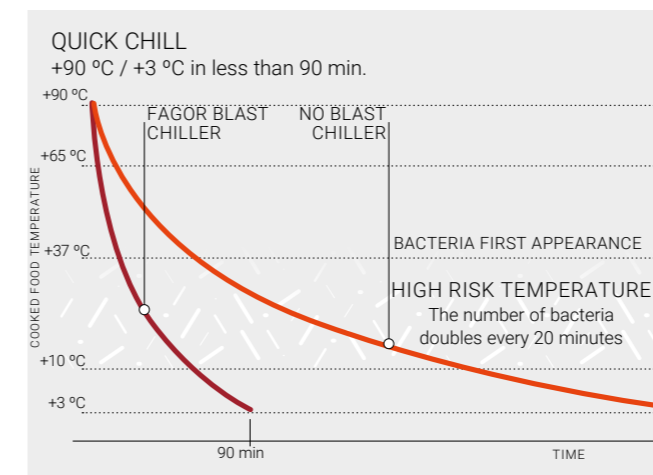

### Blast freezing

**SOFT CYCLE (STANDARD) - 240'**  
This is a cycle to freeze food with an even temperature and is therefore suitable for food that is to be cooled consistently and without sharp temperature changes or when cooked with different ingredients.

**STRONG CYCLE (INTENSIVE) - 240'**  
This is the ideal cycle to freeze half cooked food or semi-prepared dishes. It is also suitable for raw food. It allows you to keep frozen food for a long time.

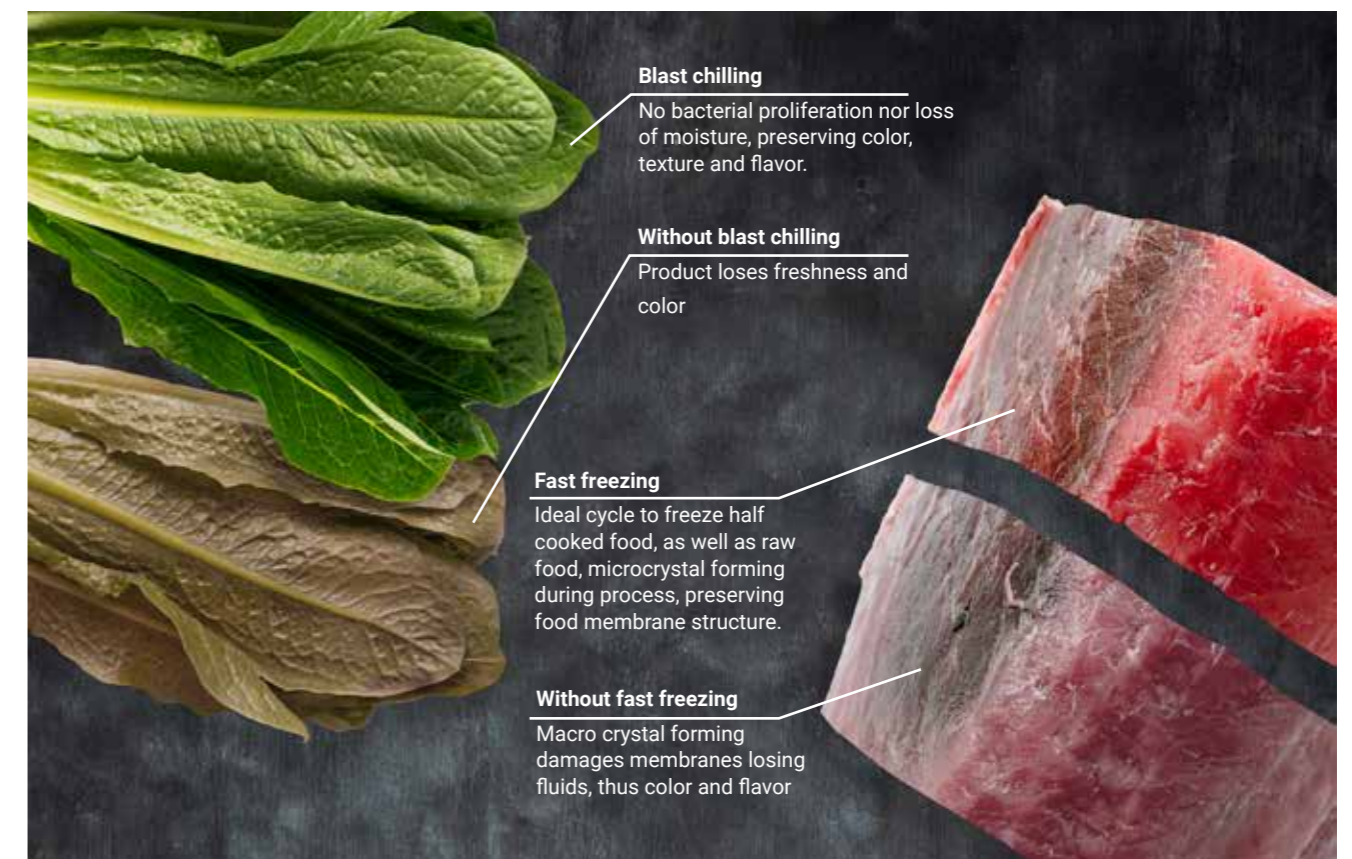
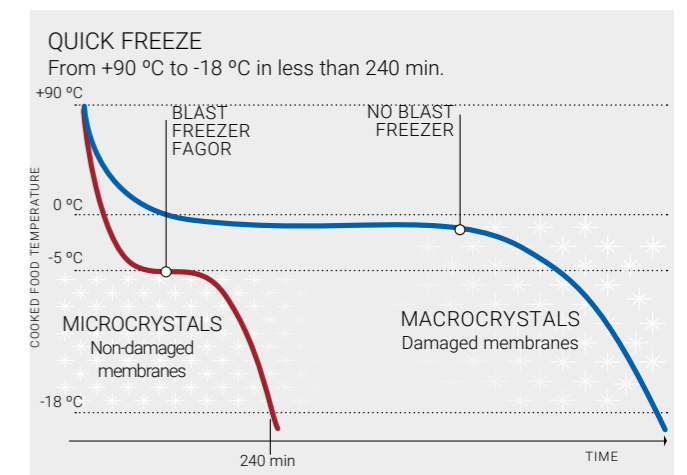



# Features



	ADVANCE	CONCEPT	COOK & CHILL	ROLL-IN
Insulation (mm)	60	60	60	100
Refrigerant + / -	R290 / R452a	R290	R290 / R452a	R452a
Climate class	5	5	5	5
CHILLING CYCLE	Yes	Yes	Yes	Yes
FREEZING CYCLE	Yes	Yes	Yes	Yes
HARD MODE	Yes	Yes	Yes	Yes
SOFT MODE	Yes	Yes	Yes	Yes
HACCP compliant	Yes	Yes	Yes	Yes
Special Cycle				
Fish Sanitization	Yes	Yes	Yes	Yes
Ice Cream Hardening	Yes	Yes	Yes	Yes
Pre-Cooling	Yes	Yes	Yes	Yes
Drying	Yes	No	Yes	Yes
Heated Prove	Standard	Optional	Standard	Standard
Ventilation Control	Yes	No	Yes	Yes
Recipee Book by Fagor	Yes	No	Yes	Yes

Electronic control

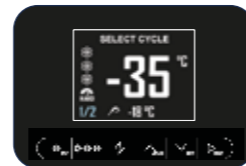

## Automatic closing door

Functional and intuitive electronic control with capacitive keyboard that allows direct access to main functions.



## Pivotable Evaporator Cover

Function that optimizes the performance by automatically setting temperatures, when doors are not opened so that the cooling unit works only when needed and always, efficiently.



## Multipurpose rack

The embedded tray guides facilitate cleaning in the cabinets. They also increase storage flexibility, allowing it to be adapted to the user's needs.



## Needle probe

The low energy consumption LED lights, strategically located on the sides, provide optimal illumination of the entire compartment.

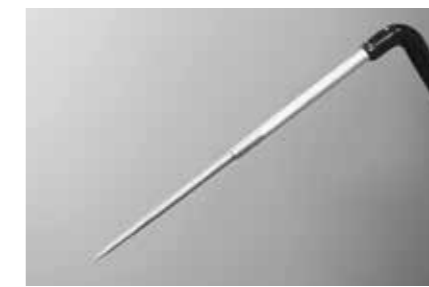

# Blast chillers



## General characteristics

- Intuitive 5" Screen touch electronic control placed in the door for more ergonomic use.
- Manual chilling process by time or probe control, both of them adjustable in each cycle as well as the evaporator fan ventilation adjustment in 5 different levels.
- 2 Manual chilling modes
  - Hard cycle: Default freezing cycle. Executes the cycle and maintains a constant temperature of -20°C.
  - Soft cycle: Default refrigeration cycle. Executes an initial cycle and maintains a constant temperature of 0°C.
- 96 preset chilling programmes by Fagor, divided in 8 food categories.
- Possibility to create a personalized cook book with up to 40 self made recipes.
- Additional cycles (Pre-Cooling, Continuous cycle, manual defrost, fish sanitization, ice cream hardening, Drying).
- Storing capacity for GN 1/1 and EN 60x40 trays (Except 3 trays version) with 65 mm distance among them.
- Electric connection 220V-240V 1N.

## Technical data

REFERENCE	MODEL	ELECTRIC CONNECTION	TEMPERATURE	PRODUCTION (KG)		GAS	COOLING POWER (kW)	ELECTRIC POWER (kW)	DIMENSIONS (MM)	€	
				COOLING	FREEZING						
19089755	ABC-031 HC	220V-240V 50Hz	+3°C / -18°C	12	6	R-290	0,565	0,41	590 x 700 x 520	-	
◎ STOCK	19099866	ABC-051 HC	220V-240V 50Hz	+3°C / -18°C	23	13	R-290	0,71	0,713	790 x 700 x 850	-
	19105085	ABC-081 HC	220V-240V 50Hz	+3°C / -18°C	40	24	R-290	1,18	0,713	790 x 800 x 1290	-
◎ STOCK	19099947	ABC-101 HC	220V-240V 50Hz	+3°C / -18°C	50	30	R-290	1,62	1,426	790 x 800 x 1420	-
	19089765	ABC-121	220V-240V 50Hz	+3°C / -18°C	60	40	R-452a	1,3	2	790 x 800 x 1600	-
	19089767	ABC-161	380V-415V 50Hz	+3°C / -18°C	80	50	R-452a	2,85	3,5	790 x 800 x 1950	-
	19089769	ABC-102	380V-415V 50Hz	+3°C / -18°C	100	65	R-452a	5,45	0	1200 x 1090 x 1766	-

## Options

		ABC-031 HC	ABC-051 HC	ABC-081 HC	ABC-101 HC	ABC-121	ABC-161	ABC-102
Opposite Opening	OP	-	0	0	0	0	0	-
UK Plug (G Type)	CI	0	0	0	0	0	0	-
Castors	C	-	0	0	0	0	0	0
60Hz	60Hz	0	0	0	0	0	0	0
USB	USB	0	0	0	0	0	0	0

# Blast chillers



## General characteristics

- Intuitive 2,8" capacitive electronic control with chilling and freezing cycles which can be controlled by time or by temperature.
  - Hard cycle: Default freezing cycle. Executes the cycle and maintains a constant temperature of -20°C.
  - Soft cycle: Default refrigeration cycle. Executes an initial cycle and maintains a constant temperature of 0°C.
- Storing capacity for GN 1/1 and EN 60x40 trays (Except 3 trays version) with 65 mm distance among them.
- Electric connection 220V-240V 1N

## Technical data

REFERENCE	MODEL	ELECTRIC CONNECTION	TEMPERATURE	PRODUCTION (KG)		GAS	COOLING POWER (kW)	ELECTRIC POWER (kW)	DEFROST	DIMENSIONS (MM)	€	
				COOLING	FREEZING							
◎ STOCK	19101748	CBC-031 HC	220V-240V 50Hz	+3°C / -18°C	12	6	R-290	0,565	0,41	STOP	590 x 700 x 520	-
◎ STOCK	19102977	CBC-051 HC	220V-240V 50Hz	+3°C / -18°C	23	13	R-290	0,71	0,55	STOP	790 x 700 x 850	-
	19105381	CBC-081 HC	220V-240V 50Hz	+3°C / -18°C	40	24	R-290	1,18	0,713	STOP	790 x 800 x 1290	-
◎ STOCK	19104477	CBC-101 HC	220V-240V 50Hz	+3°C / -18°C	50	30	R-290	1,62	1,426	STOP	790 x 800 x 1420	-

## Options

		CBC-031 HC	CBC-051 HC	CBC-081 HC	CBC-101 HC
Opposite Opening	OP	-	0	0	0
UK Plug (G Type)	CI	0	0	0	0
Castors	C	-	0	0	0
60Hz	60Hz	0	0	0	0



# COOK & CHILL blast chillers



## General characteristics

- Range of blast chillers designed to be in line with the cooking capacities of ikore ovens to perfectly balance the work loads. 6 trays blast chillers are available to order them stack with the ovens.
- Intuitive 5" Screen touch electronic control placed in the door for more ergonomic use.
- Manual chilling process by time or probe control, both of them adjustable in each cycle as well as the evaporator fan ventilation adjustment in 5 different levels.

- 2 Manual chilling modess
  - Hard cycle: Default freezing cycle. Executes the cycle and maintains a constant temperature of -20°C.
  - Soft cycle: Default refrigeration cycle. Executes an initial cycle and maintains a constant temperature of 0°C.
- Storing capacity for GN 1/1 and EN 60x40 trays (Except 3 trays version) with 65 mm distance among them.
- Electric connection 220V-240V 1N

## Technical data

REFERENCE	MODEL	ELECTRIC CONNECTION	TEMPERATURE	PRODUCTION (KG)		GAS	COOLING POWER (kW)	ELECTRIC POWER (kW)	DIMENSIONS (MM)	€
				COOLING	FREEZING					
19087540	ABCO-06 2/3 HC	220V-240V 50Hz	+3°C / -18°C	12	6	R290	0,565	0,41	656 x 633 x 630	-
19105609	ABCO-061 HC	220V-240V 50Hz	+3°C / -18°C	27	21	R290	0,71	0,713	900 x 935 x 1105	-
19105605	ABCO-101 HC	220V-240V 50Hz	+3°C / -18°C	50	30	R290	1,62	1,426	900 x 935 x 1766	-
19091443	ABCO-102	380V-415V 50Hz	+3°C / -18°C	100	65	R-452A	2,85	2,3	1200 x 1130 x 1766	-

## Options

			ABCO-06 2/3 HC	ABCO-061 HC	ABCO-101 HC	ABCO-102
UK Plug (G Type)	CI		0	0	0	-
60Hz	60Hz		0	0	0	0
USB	USB		0	0	0	0

# 20 GN 1/1 Roll-in Blast Chillers



## General characteristics

- Cold room structure made by CFC-free, high quality (40 kg/m³) polyurethane insulation panels. 70mm thickness for refrigeration models and 100 mm thickness in mixed cooling version
- Intuitive 7" Screen touch electronic control placed in the door for more ergonomic use.
- Manual chilling process by time or probe control, both of them adjustable in each cycle.
- 2 Manual chilling modes
  - Hard cycle: Default freezing cycle. Executes the cycle and maintains a constant temperature of -20°C.
  - Soft cycle: Default refrigeration cycle. Executes an initial cycle and maintains a constant temperature of 0°C.
- 2 Additional version of Cold Rooms
  - Pass-Through: Cold room could be feed from the front and back.(C)
  - High Powered version with higher evaporator capacity to blast chill or freeze higher amount of product (H)
- Tropicalised cooling unit. Suitable to work at a room temperature up to 43 °C and 65 % humidity.
- Cooling chamber and unit condenser delivered separately.
- Electric connection 220V-240V 1N

## Technical data

REFERENCE	MODEL	ELECTRIC CONNECTION	TEMPERATURE	PRODUCTION (KG)		GAS	ELECTRIC POWER (kW)	DEFROST	DIMENSIONS (MM)	UNIT CONDENSER	€
				COOLING	FREEZING						
19089779	RBP-201	220V-240V 50Hz	+3°C	70	0	R-452A	0,85	STOP	1480 x 1205 x 2120	UCS-424	-
19089780	RBP-201H	220V-240V 50Hz	+3°C	105	0	R-452A	0,85	STOP	1480 x 1205 x 2120	UCS-528	-
19089784	RBP-201C	220V-240V 50Hz	+3°C	70	0	R-452A	0,85	STOP	1480 x 1205 x 2120	UCS-424	-
19089785	RBP-201HC	220V-240V 50Hz	+3°C	105	0	R-452A	0,85	STOP	1480 x 1205 x 2120	UCS-528	-
19089788	RBM-201	220V-240V 50Hz	+3°C / -18°C	70	48	R-452A	0,85	STOP	1530 x 1255 x 2220	UCC-424	-
19089789	RBM-201H	220V-240V 50Hz	+3°C / -18°C	105	70	R-452A	0,85	STOP	1530 x 1255 x 2220	UCC-528	-
19089792	RBM-201 C	220V-240V 50Hz	+3°C / -18°C	70	48	R-452A	0,85	STOP	1530 x 1255 x 2220	UCC-424	-
19089793	RBM-201HC	220V-240V 50Hz	+3°C / -18°C	105	70	R-452A	0,85	STOP	1530 x 1255 x 2220	UCC-528	-

REFERENCE	MODEL	ELECTRIC CONNECTION	GAS	COOLING POWER (kW)	ELECTRIC POWER (kW)	DIMENSIONS (MM)	€
19017466	UCS-424	380V-415V 50Hz	R-452A	5,97	4,25	1100 x 805 x 650	-
19017467	UCS-528	380V-415V 50Hz	R-452A	6,95	4,98	1100 x 805 x 650	-
19017468	UCC-424	380V-415V 50Hz	R-452A	5,97	4,25	1045 x 765 x 637	-
19017469	UCC-528	380V-415V 50Hz	R-452A	6,95	4,98	1045 x 765 x 637	-

## Accessories

MODEL	CODE	DESCRIPTION	WIDTH	€
RC-700	19015797	Access ramp for RBM-201 Roll-in Blast Chillers	700	-



## 20 GN 2/1 Roll-in Blast Chillers



### General characteristics

- Cold room structure made by CFC-free, high quality (40 kg/m<sup>3</sup>) polyurethane insulation panels. 70mm thickness for refrigeration models and 100 mm thickness in mixed cooling version
- Intuitive 7" Screen touch electronic control placed in the door for more ergonomic use.
- Manual chilling process by time or probe control, both of them adjustable in each cycle.
- 2 Manual chilling modes
  - Hard cycle: Default freezing cycle. Executes the cycle and maintains a constant temperature of -20°C.
  - Soft cycle: Default refrigeration cycle. Executes an initial cycle and maintains a constant temperature of 0°C.
- 2 Additional version of Cold Rooms
  - Pass-Through: Cold room could be feed from the front and back.(C)
  - High Powered version with higher evaporator capacity to blast chill or freeze higher amount of product (H)
- Tropicalised cooling unit. Suitable to work at a room temperature up to 43 °C and 65 % humidity.
- Cooling chamber and unit condenser delivered separately.
- Electric connection 220V-240V 1N

### Technical data

REFERENCE	MODEL	ELECTRIC CONNECTION	TEMPERATURE	PRODUCTION (KG)		GAS	ELECTRIC POWER (kW)	DEFROST	DIMENSIONS (MM)	UNIT CONDENSER	€
				COOLING	FREEZING						
19089783	RBP-202H	50Hz	+3°C	210	0	R-452A	1,05	STOP	1670 x 1395 x 2120	UCS-842	-
19089782	RBP-202	50/60Hz	+3°C	150	0	R-452A	0,85	STOP	1670 x 1395 x 2120	UCS-1052	-
19089786	RBP-202C	50/60Hz	+3°C	150	0	R-452A	0,85	STOP	1670 x 1395 x 2120	UCC-842	-
19089787	RBP-202HC	50Hz	+3°C	210	0	R-452A	1,05	STOP	1670 x 1395 x 2120	UCC-1052	-
19089790	RBM-202	50/60Hz	+3°C / -18°C	150	100	R-452A	0,85	STOP	1720 x 1445 x 2220	UCS-842	-
19089791	RBM-202H	50/60Hz	+3°C / -18°C	210	135	R-452A	1,05	STOP	1720 x 1445 x 2220	UCS-1052	-
19089794	RBM-202 C	50/60Hz	+3°C / -18°C	150	100	R-452A	0,85	STOP	1720 x 1445 x 2220	UCC-842	-
19089795	RBM-202HC	50/60Hz	+3°C / -18°C	210	135	R-452A	1,05	STOP	1720 x 1445 x 2220	UCC-1052	-

REFERENCE	MODEL	ELECTRIC CONNECTION	GAS	COOLING POWER (kW)	ELECTRIC POWER (kW)	DIMENSIONS (MM)	€
19017468	UCS-842	380V-415V 50Hz	R-452A	10,53	6,5	1450 x 850 x 785	-
19017469	UCS-1052	380V-415V 50Hz	R-452A	13,58	8,45	1450 x 850 x 785	-
19015801	UCC-842	380V-415V 50Hz	R-452A	10,53	6,5	1450 x 850 x 785	-
19015802	UCC-1052	380V-415V 50Hz	R-452A	13,58	8,45	1450 x 850 x 785	-

### Accessories

MODEL	CODE	DESCRIPTION	WIDTH	€
RC-800	19015798	Access ramp for RBM-202 Roll-in Blast Chillers	800	-







## Bar line

—Back bar counters.....	<b>341</b>
—Back bar coolers.....	<b>343</b>
—Top load coolers.....	<b>346</b>
—Professional uprights.....	<b>348</b>
—Showcases.....	<b>353</b>

Special units or any variations from the standard model must be assembled at the factory at an additional charge over the standard model's price.

Please, contact Fagor Professional for any other variation or option that is not included on this list.

## Back bar counters



### General characteristics

- Interior constructed with AISI-304 stainless steel exterior in food grade stainless steel.
- 50 mm thickness, CFC-free, high-density (40 kg/m<sup>3</sup>) polyurethane insulation, injected under high pressure.
- Heavy-duty stainless-steel working top with 100mm high splash-back, preventing spillage behind the counter.
- Intuitive, digital display for electronic control with energy saving function to ensure an optimal control of storing products.

- Height-adjustable stainless steel legs. Height of the legs can be adjusted individually (130 mm - 200 mm) to enable convenient cleaning.
- Stamped edge interiors, easier cleaning operations to reduce potential dirt traps with a built-in drainage to get rid of waste liquid inside units
- Removable and height adjustable epoxy coated grids with a maximum loading capacity of up to 40 kg.
- Equipped with 1 grid 405x460 mm in each edge door and 1 grid 405x525 in centered doors and height adjustable 2 sets of tray slides per each full door.
- Electrical power supply: 220V-240V 1N.

### Technical data

REFERENCE	MODEL	FREQUENCY	TEMPERATURE	GAS	COOLING POWER (kW)	ELECTRIC POWER (kW)	DEFROST	GROSS VOLUME (L)	ANNUAL CONSUMPTION (kWh)	ENERGY EFFICIENCY CLASS	DIMENSIONS (LxDxH)	€
19089695	CBCP-2S	50Hz	0°C +8 °C	R-600a	0,361 (1)	0,203	STOP	355	1095 (4)	C	1492 x 600 x 1045	-
19089697	CBCP-3S	50Hz	0°C +8 °C	R-600a	0,361 (1)	0,203	STOP	551	1259 (4)	C	2017 x 600 x 1045	-
19089698	CBCP-4S	50Hz	0°C +8 °C	R-600a	0,436 (1)	0,224	STOP	747	1427 (4)	C	2542 x 600 x 1045	-
19089699	CBCP-2S GD	50Hz	0°C +8 °C	R-600a	0,361 (1)	0,207	STOP	355	1378 (5)	C	1492 x 600 x 1045	-
19089700	CBCP-3S GD	50Hz	0°C +8 °C	R-600a	0,361 (1)	0,209	STOP	551	1630 (5)	C	2017 x 600 x 1045	-
19089701	CBCP-4S GD	50Hz	0°C +8 °C	R-600a	0,436 (1)	0,232	STOP	747	1932 (5)	C	2542 x 600 x 1045	-

(1) Evap. -10°C/ Cond. 45°C (4) According to En22041 standard (5) According to EN23953 standard

### Options

			CBCP-2S	CBCP-3S	CBCP-4S
Panoramic Opening	PO		0	0	0
Left Group	LG		0	0	0
No Top	NT		0	0	0
No Splash-back	NS		0	0	0
1/3 + 2/3 Drawer	W		0	0	0
UK Plug (G Type)	CI		0	0	0
Lock	LC		0	0	0

			CBCP-2S	CBCP-3S	CBCP-4S
Castors	C		0	0	0
Back in Stainless Steel	BS		0	0	0
Frame heater	FH		0	0	0
60Hz	60Hz		0	0	0
Tilting Drawer	TV		0	0	0

### Standard Accessories

				2S	3S	4S
	19097777	EPOXY GRID SACK 405x460	pc	2	2	2
	19097775	EPOXY GRID SACK 405x525	pc	0	1	2

## Back bar remote counters



### General characteristics

- Interior constructed with AISI-304 stainless steel exterior in food grade stainless steel.
- 50 mm thickness, CFC-free, high-density (40 kg/m<sup>3</sup>) polyurethane insulation, injected under high pressure.
- Heavy-duty stainless-steel working top with 100mm high splash-back, preventing spillage behind the counter.
- Intuitive, digital display for electronic control with energy saving function to ensure an optimal control of storing products.
- Equipment without unit condenser, ready for remote cooling unit connection.

- Height-adjustable stainless steel legs. Height of the legs can be adjusted individually (130 mm - 200 mm) to enable convenient cleaning.
- Stamped edge interiors, easier cleaning operations to reduce potential dirt traps with a built-in drainage to get rid of waste liquid inside units
- Removable and height adjustable epoxy coated grids with a maximum loading capacity of up to 40 kg.
- Equipped with 1 grid 405x460 mm in each edge door and 1 grid 405x525 in centered doors and height adjustable 2 sets of tray slides per each full door.
- Electrical power supply: 220V-240V 1N.

### Technical data

REFERENCE	MODEL	FREQUENCY	TEMPERATURE	COOLING POWER	ELECTRIC POWER (kW)	DEFROST	GROSS VOLUME (L)	DIMENSIONS	€
19089702	CBCP-2S/R	50/60Hz	0°C +8 °C	0,361	0,029	STOP	355	1192 x 600 x 1045	-
19089703	CBCP-3S/R	50/60Hz	0°C +8 °C	0,361	0,029	STOP	551	1717 x 600 x 1045	-
19089704	CBCP-4S/R	50/60Hz	0°C +8 °C	0,436	0,029	STOP	747	2242 x 600 x 1045	-
19089705	CBCP-2S/R GD	50/60Hz	0°C +8 °C	0,361	0,034	STOP	355	1192 x 600 x 1045	-
19089706	CBCP-3S/R GD	50/60Hz	0°C +8 °C	0,361	0,036	STOP	551	1717 x 600 x 1045	-
19089707	CBCP-4S/R GD	50/60Hz	0°C +8 °C	0,436	0,038	STOP	747	2242 x 600 x 1045	-

(1) Evap. -10°C/ Cond. 45°C

### Options

			CBCP-2S/R	CBCP-3S/R	CBCP-4S/R
Panoramic Opening	PO		0	0	0
No Top	NT		0	0	0
No Splash-back	NS		0	0	0
1/3 + 2/3 Drawer	W		0	0	0
UK Plug (G Type)	CI		0	0	0
Lock	LC		0	0	0

			CBCP-2S/R	CBCP-3S/R	CBCP-4S/R
Back in Stainless Steel	BS		0	0	0
Frame heater	FH		0	0	0
Tilting Drawer	TV		0	0	0

### Standard Accessories

				2S	3S	4S
	19097777	EPOXY GRID SACK 405x460	pc	2	2	2
	19097775	EPOXY GRID SACK 405x525	pc	0	1	2



## BACK BAR COOLERS

## BBC Series



## General characteristics

- Interior constructed in grey plastic coated steel, exterior constructed in black plastic coated steel.
- 50 mm thickness, CFC-free, high-density (40 kg/m<sup>3</sup>) polyurethane insulation, injected under high pressure.
- Heavy-duty stainless-steel working top with 30mm CFC-free, high-density (40 kg/m<sup>3</sup>) polyurethane insulation.
- Intuitive, digital display for electronic control with energy saving function to ensure an optimal control of storing products.
- Integrated door handle that avoids dust and dirt collection.
- Double-glazed doors insulated with low thermal emissivity to reduce heat transfer with ergonomic handle. (Display models)
- Equipped with door lock.
- Removable and height adjustable grey coated steel grids with a maximum loading capacity of up to 40 kg.
- Electrical power supply: 220V-240V 1N

## Technical data

REFERENCE	MODEL	FREQUENCY	TEMPERATURE	GAS	COOLING POWER (kW)	ELECTRIC POWER (kW)	DEFROST	GROSS VOLUME (L)	ANNUAL CONSUMPTION (kWh)	ENERGY EFFICIENCY CLASS	DIMENSIONS (LxDxH)	€
19106108	RBBC-2	50Hz	0°C +8 °C	R600a	0,293	0,175	STOP	264	171 (4)	B	1435 x 512 x 850	-
19106109	RBBC-3	50Hz	0°C +8 °C	R600a	0,293	0,175	STOP	413	288 (4)	B	1989 x 512 x 850	-

(1) Evap. -10°C/ Cond. 45°C

(5) According to EN23953 standard

## Options

			RBBC-2	RBBC-3
Panoramic Opening	PO		●	●
Left Group	LG		●	●
UK Plug (G Type)	CI		0	0
Lock	LC		●	●
60Hz	60Hz		0	0

## Standard Accessories

				RBBC-2	RBBC-3
	19097777	EPOXY GRID SACK 405x460	pc	2	2
	19097775	EPOXY GRID SACK 405x525	pc	0	1
	19106517	STEEL GRID SUPPORT	pc	2	3

## BACK BAR COOLERS

## BBC Series Display



## General characteristics

- Interior constructed in grey coated steel, exterior constructed in black coated steel.
- 60 mm thickness, CFC-free, high-density (40 kg/m<sup>3</sup>) polyurethane insulation, injected under high pressure.
- Heavy-duty stainless-steel working top with 20mm CFC-free, high-density (40 kg/m<sup>3</sup>) polyurethane insulation.
- Intuitive, digital display for electronic control with energy saving function to ensure an optimal control of storing products.
- Double-glazed doors insulated with low thermal emissivity to reduce heat transfer with ergonomic handle.
- Equipped with door lock.
- Removable and height adjustable grey coated steel grids with a maximum loading capacity of up to 40 kg.
- Electrical power supply: 220V-240V 1N

## Technical data

REFERENCE	MODEL	FREQUENCY	TEMPERATURE	GAS	COOLING POWER (kW)	ELECTRIC POWER (kW)	DEFROST	GROSS VOLUME (L)	ANNUAL CONSUMPTION (kWh)	ENERGY EFFICIENCY CLASS	DIMENSIONS (LxDxH)	€
19106034	RBBC-2 GD	50Hz	0°C +8 °C	R600a	0,293	0,175	STOP	264	257	B	1435 x 512 x 850	-
19106035	RBBC-3 GD	50Hz	0°C +8 °C	R600a	0,293	0,175	STOP	413	387	C	1989 x 512 x 850	-

(1) Evap. -10°C/ Cond. 45°C

(5) According to EN23953 standard

## Options

			RBBC-2 GD	RBBC-3 GD
Panoramic Opening	PO		●	●
Left Group	LG		●	●
UK Plug (G Type)	CI		0	0
Lock	LC		●	●
60Hz	60Hz		0	0
Glass Door	GD		●	●

## Standard Accessories

				RBBC-2	RBBC-3
	19097777	EPOXY GRID SACK 405x460	pc	2	2
	19097775	EPOXY GRID SACK 405x525	pc	0	1
	19106517	STEEL GRID SUPPORT	pc	2	3

BACK BAR COOLERS

# ERM Series



### General characteristics

- Interior constructed in grey coated steel, exterior constructed in black coated steel.
- Interior and exterior built-in with food grade stainless steel for intensive professional applications. (SS Models)
- Intuitive, digital display for electronic control with energy saving function to ensure an optimal control of storing products.
- ON/OFF power switch
- Integrated door handle that avoids dust and dirt collection.
- Double-glazed doors insulated with low thermal emissivity to reduce heat transfer with ergonomic handle. (Display models)
- Equipped with door lock.
- Electrical power supply: 220V-240V 1N

### Technical data

REFERENCE	MODEL	FREQUENCY	TEMPERATURE	GAS	COOLING POWER (kW)	ELECTRIC POWER (kW)	DEFROST	GROSS VOLUME (L)	ANNUAL CONSUMPTION (kWh)	ENERGY EFFICIENCY CLASS	DIMENSIONS (LXDXH)	€
900 mm Height												
Black Coated												
19089713	EERM-1	50/60Hz	0°C +8 °C	R290	0,49 (1)	0,22	STOP	142	1063 (5)	G	625 x 565 x 900	-
19089714	EERM-2	50/60Hz	0°C +8 °C	R290	0,369 (1)	0,28	STOP	214	1175 (5)	G	925 x 565 x 900	-
19089715	EERM-3	50/60Hz	0°C +8 °C	R290	0,369 (1)	0,285	STOP	327	1186 (5)	G	1375 x 565 x 900	-
Stainless Steel												
19089710	EERM-1 SS	50/60Hz	0°C +8 °C	R290	0,49 (1)	0,22	STOP	142	1063 (5)	G	625 x 565 x 900	-
19089711	EERM-2 SS	50/60Hz	0°C +8 °C	R290	0,369 (1)	0,28	STOP	214	1281 (5)	G	925 x 565 x 900	-
19089712	EERM-3 SS	50/60Hz	0°C +8 °C	R290	0,369 (1)	0,285	STOP	327	1475 (5)	G	1375 x 565 x 900	-
900 mm Height												
Black Coated												
19089719	EERMU-1	50/60Hz	0°C +8 °C	R290	0,49 (1)	0,22	STOP	142	1063 (5)	G	625 x 565 x 800	-
19089720	EERMU-2	50/60Hz	0°C +8 °C	R290	0,369 (1)	0,28	STOP	214	1281 (5)	G	925 x 565 x 800	-
19089721	EERMU-3	50/60Hz	0°C +8 °C	R290	0,369 (1)	0,285	STOP	327	1475 (5)	G	1375 x 565 x 800	-
Stainless Steel												
19089716	EERMU-1 SS	50/60Hz	0°C +8 °C	R290	0,49 (1)	0,22	STOP	142	1063 (5)	G	625 x 565 x 800	-
19089717	EERMU-2 SS	50/60Hz	0°C +8 °C	R290	0,369 (1)	0,28	STOP	214	1281 (5)	G	925 x 565 x 800	-
19089718	EERMU-3 SS	50/60Hz	0°C +8 °C	R290	0,369 (1)	0,285	STOP	327	1475 (5)	G	1375 x 565 x 800	-

(1) Evap. -10°C/ Cond. 45°C (5) According to EN23953 standard

### Options

			EERM-1	EERM-2	EERM-3
Panoramic Opening	PO		●	●	●
UK Plug (G Type)	CI		○	○	○
Lock	LC		●	●	●
60Hz	60Hz		●	●	●
Glass Door	GD		●	●	●

### Standard Accessories

			EERM-1	EERM-2	EERM-3
	19106469	EPOXY GRID ERM-1	2		
	19106510	EPOXY GRID ERM-2		2	
	19106511	EPOXY GRID ERM-3			2
	19106517	STEEL GRID SUPPORT	2	3	4

BACK BAR COOLERS

# Top Load Bottle Coolers



### General characteristics

- Interior and exterior built-in with food grade stainless steel for intensive professional applications.
- CFC-free, high-density (40 kg/m³) polyurethane insulation, injected under high pressure.
- Static cooling system generated by copper piping and aluminum flaps evaporator.
- Analogical thermostat for temperature control.
- Top mounted, fully integrated handle stainless-steel sliding door.
- Height-adjustable stainless steel legs. Height of the legs can be adjusted individually (65 mm - 88 mm) to enable convenient balance of the equipment.
- Hermetically sealed compressor located in the right-front of the devices.
- Removable front panel with front breathing design allowing machine to be embedded without penalizing performance.
- Waste water drainage and curved joints between inner panels for easy cleaning.
- Electrical power supply: 220V-240V 1N 50Hz

### Technical data

REFERENCE	MODEL	FREQUENCY	TEMPERATURE	GAS	COOLING POWER (kW)	ELECTRIC POWER (kW)	GROSS VOLUME (L)	ANNUAL CONSUMPTION (kWh)	ENERGY EFFICIENCY CLASS	DIMENSIONS (LXDXH)	€
19089722	TLC-2 SS	50Hz	-1°C +6°C	R-600a	0,105 (1)	0,109	223	383 (5)	C	1014 x 560 x 850	-
19089723	TLC-3 SS	50Hz	-1°C +6°C	R-600a	0,292 (1)	0,207	381	369 (5)	C	1504 x 560 x 850	-
19089724	TLC-4 SS	50Hz	-1°C +6°C	R-600a	0,292 (1)	0,207	539	843 (5)	D	1994 x 560 x 850	-
19089725	TLC-5 SS	50Hz	-1°C +6°C	R-600a	0,292 (1)	0,207	696	770 (5)	D	2482 x 560 x 850	-

(1) Evap. -10°C/ Cond. 45°C (5) According to EN23953 standard

### Options

			TLC-2 SS	TLC-3 SS	TLC-4 SS	TLC-5 SS
UK Plug (G Type)	CI		○	○	○	○
60Hz	60Hz		○	○	○	○

# Professional Refrigeration Upright



## General characteristics

- Interior constructed with thermoformed food grade ABS.
- Exterior finishing
  - Satin finished food grade stainless steel.
  - White coated galvanized steel
- CFC-free, high-density (40 kg/m<sup>3</sup>) polyurethane insulation, injected under high pressure.
- Rounded edge interiors, for easier cleaning operations to reduce potential dirt traps with a built-in drainage to get rid of waste liquid inside units.
- Intuitive, digital display for electronic control with energy saving function to ensure an optimal control of storing products.

- ON/OFF power switch.
- Removable pull-out/push-in magnetic door gasket to keep maximum hygiene and maintain the insulating properties
- Hinged doors with automatic return for a perfect closing that minimize temperature gain. Doors have a 120° dwell position and close automatically at less than 90°.
- Door designed for easy opening orientation modification.
- Electrical power supply: 220V-240V 1N

## Standard Accessories

				UP-251	UP-451	UP-651	UN-251	UN-451	UN-651
	19106512	EPOXY GRID 493x392MM	pc	2					
	19106517	STEEL GRID SUPPORT	pc	2					
	19106513	EPOXY GRID 497x510MM	pc		3				
	19106514	EPOXY GRID 497x380MM	pc		1				
	19106515	EPOXY GRID 651x510MM	pc			3			
	19106516	EPOXY GRID 651x380MM	pc			1			

## PROFESSIONAL REFRIGERATION UPRIGHT

# Refrigerators



## Specific characteristics

- Doors with ergonomic, full-length, robust, perfectly integrated handle. that ensures practical opening and avoids dust and dirt collection.
- Internally designed forced draft cooling system with the evaporator integrated in the back side of the upright guarantees optimal cold distribution, efficiency and performance.

- Optimal air circulation system that guarantees a balanced and constant distribution throughout the equipment, so that the temperature remains uniform. It helps preserve food for longer.

## Technical data

	REFERENCE	MODEL	FREQUENCY	TEMPERATURE	GAS	COOLING POWER (kW)	ELECTRIC POWER (kW)	DEFROST	GROSS VOLUME (L)	ANNUAL CONSUMPTION (kWh)	ENERGY EFFICIENCY CLASS	DIMENSIONS (LxDxH)	€
⊕ STOCK	19089735	UP-251	50Hz	0°C +8 °C	R-600a	0,14 (1)	0,091	STOP	125	488 (4)	A	626 x 600 x 850	-
⊕ STOCK	19089736	UP-451	50Hz	0°C +8 °C	R-600a	0,292 (1)	0,186	STOP	460	866 (4)	D	626 x 740 x 1865	-
⊕ STOCK	19089737	UP-651	50Hz	0°C +8 °C	R-600a	0,292 (1)	0,186	STOP	600	954 (4)	D	780 x 740 x 1865	-
⊕ STOCK	19089729	UP-251 SS	50Hz	0°C +8 °C	R-600a	0,14 (1)	0,091	STOP	125	488 (4)	A	626 x 600 x 850	-
	19089730	UP-451 SS	50Hz	0°C +8 °C	R-600a	0,292 (1)	0,186	STOP	460	866 (4)	D	626 x 740 x 1865	-
	19089731	UP-651 SS	50Hz	0°C +8 °C	R-600a	0,292 (1)	0,186	STOP	600	954 (4)	D	780 x 740 x 1865	-

(1) Evap. -10°C/ Cond. 45°C (4) According to En22041 standard

## Options

			UP-251	UP-451	UP-651	UP-251 SS	UP-451 SS	UP-651 SS
UK Plug (G Type)	Cl		0	0	0	0	0	0
60Hz	60Hz		0	0	0	0	0	0

# Freezers



## Specific characteristics

- Doors with ergonomic, full-length, robust, perfectly integrated handle. that ensures practical opening and avoids dust and dirt collection.
- Removable pull-out/push-in magnetic door gasket to keep maximum hygiene and maintain the insulating properties
- Hinged doors with automatic return for a perfect closing that minimize temperature gain. Doors have a 120° dwell position and close automatically at less than 90°.
- Internally designed static cooling system. Interior shelves built-in epoxy coated copper pipes, acts as an evaporator to cool down the products.
- Ice defrosting process needs to be done manually.
- 400 and 600 models with 7 levels of grills and 235mm distance among them.
- 200 models with 3 levels and 200mm distance among them.

## Technical data

REFERENCE	MODEL	FREQUENCY	TEMPERATURE	GAS	COOLING POWER (kW)	ELECTRIC POWER (kW)	DEFROST	GROSS VOLUME (L)	DIMENSIONS (LXDHX)	€
STOCK 19089738	UN-251	50Hz	-15°C -22°C	R-290	0,218 (2)	0,142	-	125	626 x 600 x 850	-
STOCK 19089739	UN-451	50Hz	-15°C -22°C	R-290	0,228 (2)	0,143	-	460	626 x 740 x 1865	-
STOCK 19089740	UN-651	50Hz	-15°C -22°C	R-290	0,199 (2)	0,145	-	600	780 x 740 x 1865	-
STOCK 19089732	UN-251 SS	50Hz	-15°C -22°C	R-290	0,218 (2)	0,142	-	125	626 x 600 x 850	-
19089733	UN-451 SS	50Hz	-15°C -22°C	R-290	0,228 (2)	0,143	-	460	626 x 740 x 1865	-
19089734	UN-651 SS	50Hz	-15°C -22°C	R-290	0,199 (2)	0,145	-	600	780 x 740 x 1865	-

(1) Evap. -10°C/ Cond. 45°C

(4) According to En22041 standard

## Options

			UN-251	UN-451	UN-651	UN-251 SS	UN-451 SS	UN-651 SS
UK Plug (G Type)	Cl		0	0	0	0	0	0
60Hz	60Hz		0	0	0	0	0	0

# Displays



## Specific characteristics

- Double-glazed doors insulated with low thermal emissivity to reduce heat transfer with ergonomic handle.
- Internally designed forced draft cooling system with the evaporator integrated in the back side of the upright guarantees optimal cold distribution, efficiency and performance.
- Optimal air circulation system that guarantees a balanced and constant distribution throughout the equipment, so that the temperature remains uniform. It helps preserve food for longer.
- Low energy consumption LED lighting horizontally located in the frame.

## Technical data

REFERENCE	MODEL	FREQUENCY	TEMPERATURE	GAS	COOLING POWER (kW)	ELECTRIC POWER (kW)	DEFROST	GROSS VOLUME (L)	ANNUAL CONSUMPTION (kWh)	ENERGY EFFICIENCY CLASS	DIMENSIONS (LXDHX)	€
STOCK 19089741	UP-251 GD	50Hz	0°C +8 °C	R-600a	0,14 (1)	0,091	STOP	125	613 (5)	B	626 x 600 x 850	-
19089742	UP-451 GD	50Hz	0°C +8 °C	R-600a	0,292 (1)	0,193	STOP	460	1024 (5)	B	626 x 740 x 1865	-
19089743	UP-651 GD	50Hz	0°C +8 °C	R-600a	0,292 (1)	0,193	STOP	600	1095 (5)	B	780 x 740 x 1865	-
19100114	UP-251 SS GD	50Hz	0°C +8 °C	R-600a	0,14 (1)	0,091	STOP	125	613 (5)	B	626 x 600 x 850	-
19100115	UP-451 SS GD	50Hz	0°C +8 °C	R-600a	0,292 (1)	0,193	STOP	460	1024 (5)	B	626 x 740 x 1865	-
19100116	UP-651 SS GD	50Hz	0°C +8 °C	R-600a	0,292 (1)	0,193	STOP	600	1095 (5)	B	780 x 740 x 1865	-

(1) Evap. -10°C/ Cond. 45°C

(5) According to En22041 standard

## Options

			UP-251 SS	UP-451 SS	UP-651 SS	UP-251 SS GD	UP-451 SS GD	UP-651 SS GD
UK Plug (G Type)	Cl		0	0	0	0	0	0
60Hz	60Hz		0	0	0	0	0	0
Glass door	GD		●	●	●	●	●	●



# Snack Showcases



## General characteristics

- Interior built-in with food grade stainless steel for intensive professional applications.
- Exterior constructed with anodized aluminum profile, tempered glass on top and back and Black coated PVC in the laterals.
- 2 cover versions available:
  - Curved glass cover (C)
  - Flat glass cover with sliding door in the front. (P)
- CFC-free, high-density (40 kg/m<sup>3</sup>) polyurethane insulation, injected under high pressure.
- Intuitive digital control allows temperature parameters to be adjusted

- easily and quickly.
- Internal compartment sized to fit with 40mm depth GN 1/3 containers (not included)
- Low energy consumption LED lighting horizontally located in the frame.
- Static cooling system. Cold is generated through a copper coil located on the bottom plate of the vitrin. Except neutral version
- Water drain especially designed to make cleaning operations quicker and easier, optimum for hygiene.
- Electrical power supply: 220V-240V 1N

## Technical data

REFERENCE	MODEL	FREQUENCY	TEMPERATURE	GAS	COOLING POWER (kW)	ELECTRIC POWER (kW)	ANNUAL CONSUMPTION (kWh)	ENERGY EFFICIENCY CLASS	DIMENSIONS (LxDxH)	€
19089745	ST-139P	50Hz	+2°C +8°C	R-600a	0,169 (1)	0,105	587 (5)	B	1380 x 415 x 270	-
19089747	ST-139C	50Hz	+2°C +8°C	R-600a	0,169 (1)	0,105	587 (5)	B	1380 x 415 x 270	-
19089746	ST-175P	50Hz	+2°C +8°C	R-600a	0,169 (1)	0,106	641 (5)	B	1732 x 415 x 270	-
19089748	ST-175C	50Hz	+2°C +8°C	R-600a	0,169 (1)	0,106	641 (5)	B	1732 x 415 x 270	-
19089749	ST-139NP	-	-	-	-	-	-	-	1380 x 415 x 270	-
19089750	ST-175NP	-	-	-	-	-	-	-	1732 x 415 x 270	-
19089751	ST-139NC	-	-	-	-	-	-	-	1380 x 415 x 270	-
19089752	ST-175NC	-	-	-	-	-	-	-	1732 x 415 x 270	-

(1) Evap. -10°C/ Cond. 45°C

(5) According to EN23953 standard

## Options

			ST-139P	ST-175C
UK Plug (G Type)	CI		0	0
60Hz	60Hz		0	0

# Sushi Showcases



## General characteristics

- Interior and exterior built-in with food grade stainless steel for intensive professional applications with perforated inner tray for food.
- Exterior constructed with anodized aluminum profile, tempered glass on top and back and Black coated PVC in the laterals.
- CFC-free, high-density (40 kg/m<sup>3</sup>) polyurethane insulation, injected under high pressure.
- Intuitive digital control allows temperature parameters to be adjusted easily and quickly.
- Low energy consumption LED lighting horizontally located in the frame.
- Double static cooling system. Cold is generated through a copper

- coil located on the bottom plate of the vitrin and a copper coil with aluminum fins mounted in the urved glass cover.
- Water drain especially designed to make cleaning operations quicker and easier, optimum for hygiene.
- Electrical power supply: 220V-240V 1N

## Technical data

REFERENCE	MODEL	FREQUENCY	TEMPERATURE	GAS	COOLING POWER (kW)	ELECTRIC POWER (kW)	ANNUAL CONSUMPTION (kWh)	ENERGY EFFICIENCY CLASS	DIMENSIONS (LxDxH)	€
19089753	SS-139C	50Hz	-4°C +1°C	R-600a	0,169 (1)	0,105	548 (5)	B	1380 x 415 x 278	-
19089754	SS-175C	50Hz	-4°C +1°C	R-600a	0,169 (1)	0,106	730 (5)	B	1730 x 415 x 270	-

(1) Evap. -10°C/ Cond. 45°C

(5) According to EN23953 standard

## Options

			SS-139C	SS-175C
UK Plug (G Type)	CI		0	0
60Hz	60Hz		0	0





# Wine cellars & meat dry agers

- Wine cellars..... 359
- Meat dry agers ..... 362



Compact and reliable components ideal for any bar professional



# A wine cellar for each need

How many bottles will fit in ?

We suggest you to use this type of shelf for ... 

Layout example according to the wine cellar height 2300 / 2600

Cellar height  
**2300 / 2600**  
mm

 Capacity  
**09** bottles/shelf

 Capacity  
**08** bottles/shelf

 Capacity  
**08** bottles/shelf

 Capacity  
**43** bottles/shelf

 Capacity  
**43** bottles/shelf

Still and/or low alcohol wines

Champagne, sparkling and high alcohol wines

 **x2 / x2**  
DIS-20

 **x1 / x2**  
DIS-0-180

 **x1 / x2**  
DIS-0-90

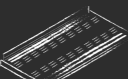
 **x1 / x1**  
DIS-90

Base

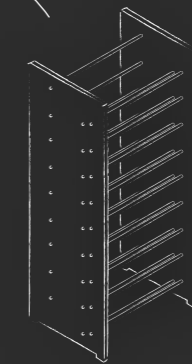

DIM-20-23

DIM-20-26

Capacity  
**63** bottles/block

Capacity  
**77** bottles/block

**09** shelves/block

**11** shelves/block

DIM-20-23  
DIM-20-26

 Capacity  
**07** bottles/shelf



ADVANCE

# Wine cellars

## General characteristics

- Wine cellar specially designed to preserve, display and distribute wine.
- Interior and exterior built-in with coated stainless steel for intensive professional applications.
- Intuitive, digital display for electronic control with energy saving function to ensure an optimal control of storing products.
- Models available in central or wall configuration. – Double glazed side and central walls with double-layered glass and air chamber filled with argon between them.
- Glasses and door frames heated to avoid condensations.
  - Models available in one (1) and two (2) doors.
- Hinged doors for optimize space usage and easy work.
- Models available in two (2) colors: Black (BLA) and Gray (GRE).
- For easy delivery, wine cellars are shipped in two sections: body and removable top section containing complete refrigeration unit.
- Decorative plinth included as a standard element. Shelves and hooks should be requested separately and are supplied disassembled.
- Operating temperature: climate class V (ambient temperature up to +40°C and relative humidity 40%).
- Electric connection 220V-240V 1N

## Technical data

REFERENCE	MODEL	FRE-QUENCY	TEMPERATURE	DOORS	TEMPERATURES	GAS	COOLING POWER	ELECTRIC POWER	DEFROST	DIMENSIONS (LXDXH)	€
<b>CENTRAL WINE CELLARS</b>											
19092285	FWC-2301-T1-C-L-W-GRE TR	50Hz	+4°C +18°C	1	1	R-290	0,74(6)	1,335	ELECTRIC	862 x 632 x 1800	-
19092297	FWC-2302-T2-C-LR-W-GRE TR	50Hz	+4°C +18°C	2	2	R-290	0,74(6)	2,52	ELECTRIC	1697 x 632 x 1800	-
19092282	FWC-2301-T1-C-L-W-BLA TR	50Hz	+4°C +18°C	1	1	R-290	0,74(6)	1,335	ELECTRIC	862 x 632 x 1800	-
19092294	FWC-2302-T2-C-LR-W-BLA TR	50Hz	+4°C +18°C	2	2	R-290	0,74(6)	2,52	ELECTRIC	1697 x 632 x 1800	-
19092303	FWC-2601-T1-C-L-W-GRE TR	50Hz	+4°C +18°C	1	1	R-290	0,74(6)	1,42	ELECTRIC	862 x 632 x 2100	-
19092315	FWC-2602-T2-C-LR-W-GRE TR	50Hz	+4°C +18°C	2	2	R-290	0,74(6)	2,8	ELECTRIC	1697 x 632 x 2100	-
19092300	FWC-2601-T1-C-L-W-BLA TR	50Hz	+4°C +18°C	1	1	R-290	0,74(6)	1,42	ELECTRIC	862 x 632 x 2100	-
19092312	FWC-2602-T2-C-LR-W-BLA TR	50Hz	+4°C +18°C	2	2	R-290	0,74(6)	2,8	ELECTRIC	1697 x 632 x 2100	-
19092291	FWC-2302-T1-C-LR-W-GRE TR	50Hz	+4°C +18°C	2	1	R-290	1,48(6)	2,295	ELECTRIC	1697 x 632 x 1800	-
19092288	FWC-2302-T1-C-LR-W-BLA TR	50Hz	+4°C +18°C	2	1	R-290	1,48(6)	2,295	ELECTRIC	1697 x 632 x 1800	-
19092309	FWC-2602-T1-C-LR-W-GRE TR	50Hz	+4°C +18°C	2	1	R-290	1,48(6)	2,7	ELECTRIC	1697 x 632 x 2100	-
19092306	FWC-2602-T1-C-LR-W-BLA TR	50Hz	+4°C +18°C	2	1	R-290	1,48(6)	2,7	ELECTRIC	1697 x 632 x 2100	-
<b>WALL-MOUNTED WINE CELLARS</b>											
19092321	FWC-2301-T1-W-L-W-GRE TR	50Hz	+4°C +18°C	1	1	R-290	0,74(6)	1,275	ELECTRIC	862 x 632 x 1800	-
19092333	FWC-2302-T2-W-LR-W-GRE TR	50Hz	+4°C +18°C	2	2	R-290	0,74(6)	2,4	ELECTRIC	1697 x 632 x 1800	-
19092318	FWC-2301-T1-W-L-W-BLA TR	50Hz	+4°C +18°C	1	1	R-290	0,74(6)	1,275	ELECTRIC	862 x 632 x 1800	-
19092330	FWC-2302-T2-W-LR-W-BLA TR	50Hz	+4°C +18°C	2	2	R-290	0,74(6)	2,4	ELECTRIC	1697 x 632 x 1800	-
19092339	FWC-2601-T1-W-L-W-GRE TR	50Hz	+4°C +18°C	1	1	R-290	0,74(6)	1,36	ELECTRIC	862 x 632 x 2100	-
19092351	FWC-2602-T2-W-LR-W-GRE TR	50Hz	+4°C +18°C	2	2	R-290	0,74(6)	2,68	ELECTRIC	1697 x 632 x 2100	-
19092336	FWC-2601-T1-W-L-W-BLA TR	50Hz	+4°C +18°C	1	1	R-290	0,74(6)	1,36	ELECTRIC	862 x 632 x 2100	-
19092348	FWC-2602-T2-W-LR-W-BLA TR	50Hz	+4°C +18°C	2	2	R-290	0,74(6)	2,68	ELECTRIC	1697 x 632 x 2100	-
19092327	FWC-2302-T1-W-LR-W-GRE TR	50Hz	+4°C +18°C	2	1	R-290	1,48(6)	2,175	ELECTRIC	1697 x 632 x 1800	-
19092324	FWC-2302-T1-W-LR-W-BLA TR	50Hz	+4°C +18°C	2	1	R-290	1,48(6)	2,175	ELECTRIC	1697 x 632 x 1800	-
19092345	FWC-2602-T1-W-LR-W-GRE TR	50Hz	+4°C +18°C	2	1	R-290	1,48(6)	2,58	ELECTRIC	1697 x 632 x 2100	-
19092342	FWC-2602-T1-W-LR-W-BLA TR	50Hz	+4°C +18°C	2	1	R-290	1,48(6)	2,58	ELECTRIC	1697 x 632 x 2100	-

(6) Evap. -10°C/ Cond. 55°C

## Options

		FWC
UK Plug (G Type)	CI	0
Remote Group	RG	0
60Hz	60Hz	0

# Accessories

PICTURE	ICON	MODEL	REFERENCE	BOTTLES PER SHELF	SHELVES X BODY CELLAR	BOTTLES PER BODY CELLAR	WHERE USED	€
<b>METHACRYLATE STRUCTURE WITH ROD SHELVING</b>								
		19067947	DIM 20-23	7	9	63	H=2300mm Cellars	
		19067948	DIM 20-26	7	11	77	H=2600mm Cellars	

PICTURE	ICON	MODEL	REFERENCE	BOTTLES PER SHELF	SHELVES X BODY CELLAR	BOTTLES PER BODY CELLAR	BOTTLES PER BODY CELLAR		€
							H=2300MM	H=2600MM	
<b>STAINLESS STEEL SHELVES</b>									
		19067949	DIS-90	43	3	4	168	210	
		19067950	DIS 0-90	8	9	11	72	108	
		19067951	DIS 0-180	8	9	11	72	108	
		19067952	DIS-20	9	9	11	81	99	

## Examples of shelf layout

  <table border="1"> <thead> <tr> <th rowspan="2">TYPE</th> <th colspan="2">No SHELVES</th> </tr> <tr> <th>2300 mm (118 BOTTLES)</th> <th>2600 mm (134 BOTTLES)</th> </tr> </thead> <tbody> <tr> <td>- DIS-0-180</td> <td>2</td> <td>3</td> </tr> <tr> <td>- DIS-0-90</td> <td>2</td> <td>3</td> </tr> <tr> <td>- DIS-90</td> <td>1</td> <td>1</td> </tr> <tr> <td>- BASE</td> <td>1</td> <td>1</td> </tr> </tbody> </table>	TYPE	No SHELVES		2300 mm (118 BOTTLES)	2600 mm (134 BOTTLES)	- DIS-0-180	2	3	- DIS-0-90	2	3	- DIS-90	1	1	- BASE	1	1	  <table border="1"> <thead> <tr> <th rowspan="2">TYPE</th> <th colspan="2">No SHELVES</th> </tr> <tr> <th>2300 mm (147 BOTTLES)</th> <th>2600 mm (165 BOTTLES)</th> </tr> </thead> <tbody> <tr> <td>- DIS-20</td> <td>2</td> <td>4</td> </tr> <tr> <td>- DIS-90</td> <td>2</td> <td>2</td> </tr> <tr> <td>- BASE</td> <td>1</td> <td>1</td> </tr> </tbody> </table>	TYPE	No SHELVES		2300 mm (147 BOTTLES)	2600 mm (165 BOTTLES)	- DIS-20	2	4	- DIS-90	2	2	- BASE	1	1	  <table border="1"> <thead> <tr> <th rowspan="2">TYPE</th> <th colspan="2">No SHELVES</th> </tr> <tr> <th>2300 mm (77 BOTTLES)</th> <th>2600 mm (94 BOTTLES)</th> </tr> </thead> <tbody> <tr> <td>- DIS-0-180</td> <td>4</td> <td>5</td> </tr> <tr> <td>- DIS-20</td> <td>5</td> <td>6</td> </tr> </tbody> </table>	TYPE	No SHELVES		2300 mm (77 BOTTLES)	2600 mm (94 BOTTLES)	- DIS-0-180	4	5	- DIS-20	5	6
TYPE		No SHELVES																																										
	2300 mm (118 BOTTLES)	2600 mm (134 BOTTLES)																																										
- DIS-0-180	2	3																																										
- DIS-0-90	2	3																																										
- DIS-90	1	1																																										
- BASE	1	1																																										
TYPE	No SHELVES																																											
	2300 mm (147 BOTTLES)	2600 mm (165 BOTTLES)																																										
- DIS-20	2	4																																										
- DIS-90	2	2																																										
- BASE	1	1																																										
TYPE	No SHELVES																																											
	2300 mm (77 BOTTLES)	2600 mm (94 BOTTLES)																																										
- DIS-0-180	4	5																																										
- DIS-20	5	6																																										
  <table border="1"> <thead> <tr> <th rowspan="2">TYPE</th> <th colspan="2">No SHELVES</th> </tr> <tr> <th>2300 mm (72 BOTTLES)</th> <th>2600 mm (88 BOTTLES)</th> </tr> </thead> <tbody> <tr> <td>- DIS-0-180</td> <td>4</td> <td>5</td> </tr> <tr> <td>- DIS-0-90</td> <td>5</td> <td>6</td> </tr> </tbody> </table>	TYPE	No SHELVES		2300 mm (72 BOTTLES)	2600 mm (88 BOTTLES)	- DIS-0-180	4	5	- DIS-0-90	5	6	  <table border="1"> <thead> <tr> <th rowspan="2">TYPE</th> <th colspan="2">No SHELVES</th> </tr> <tr> <th>2300 mm (120 BOTTLES)</th> <th>2600 mm (137 BOTTLES)</th> </tr> </thead> <tbody> <tr> <td>- DIS-20</td> <td>2</td> <td>3</td> </tr> <tr> <td>- DIS-0-90</td> <td>2</td> <td>3</td> </tr> <tr> <td>- DIS-90</td> <td>1</td> <td>1</td> </tr> <tr> <td>- BASE</td> <td>1</td> <td>1</td> </tr> </tbody> </table>	TYPE	No SHELVES		2300 mm (120 BOTTLES)	2600 mm (137 BOTTLES)	- DIS-20	2	3	- DIS-0-90	2	3	- DIS-90	1	1	- BASE	1	1	  <table border="1"> <thead> <tr> <th rowspan="2">TYPE</th> <th colspan="2">No SHELVES</th> </tr> <tr> <th>2300 mm (104 BOTTLES)</th> <th>2600 mm (121 BOTTLES)</th> </tr> </thead> <tbody> <tr> <td>- DIS-20</td> <td>5</td> <td>6</td> </tr> <tr> <td>- DIS-0-90</td> <td>2</td> <td>3</td> </tr> <tr> <td>- BASE</td> <td>1</td> <td>1</td> </tr> </tbody> </table>	TYPE	No SHELVES		2300 mm (104 BOTTLES)	2600 mm (121 BOTTLES)	- DIS-20	5	6	- DIS-0-90	2	3	- BASE	1	1
TYPE		No SHELVES																																										
	2300 mm (72 BOTTLES)	2600 mm (88 BOTTLES)																																										
- DIS-0-180	4	5																																										
- DIS-0-90	5	6																																										
TYPE	No SHELVES																																											
	2300 mm (120 BOTTLES)	2600 mm (137 BOTTLES)																																										
- DIS-20	2	3																																										
- DIS-0-90	2	3																																										
- DIS-90	1	1																																										
- BASE	1	1																																										
TYPE	No SHELVES																																											
	2300 mm (104 BOTTLES)	2600 mm (121 BOTTLES)																																										
- DIS-20	5	6																																										
- DIS-0-90	2	3																																										
- BASE	1	1																																										

CONCEPT

# Wine cellars



## General characteristics

- Wine cooler cabinets with modern and elegant solutions for wine storage and distribute bottles ready for consumption.
- Exterior constructed with black coated galvanized steel and interior with sanitary thermoformed plastic with embedded inner tray slides.
- 45 mm, thickness, CFC-free, high-density (40 kg/m³) polyurethane insulation, injected under high pressure.
- Intuitive, digital display for electronic control with energy saving function to ensure an optimal control of storing products.
- Internally designed forced draft cooling system with low consumption electronic components to guarantee optimal equipment efficiency and performance.
- Double-glazed doors insulated with low thermal emissivity to reduce heat transfer in refrigeration and UV filter for sunlight.
- Removable and height adjustable black epoxy coated grids. Wooden shelves are available under request.
- Low energy consumption LED lighting horizontally located in the interior of compartment.
- Electric connection 220V-240V 1N.

## Technical data

REFERENCE	MODEL	FREQUENCY	TEMPERATURE	GAS	COOLING POWER	ELECTRIC POWER	DEFROST	ANNUAL CONSUMPTION kWh	ENERGY EFFICIENCY CLASS	DIMENSIONS (LxDxH)	€
19089796	CWC-180	50Hz	+4°C +18°C	R-600a	0,209 (1)	0,225	STOP	423 (5)	D	506 x 579 x 941	-
19089798	CWC-300	50Hz	+4°C +18°C	R-600a	0,292 (1)	0,257	STOP	909 (5)	E	620 x 655 x 1850	-
19089800	CWC-600	50Hz	+4°C +18°C	R-600a	0,584 (1)	0,513	STOP	1495 (5)	E	1250 x 655 x 1850	-

(1) Evap. -10°C/ Cond. 45°C (5) According to EN23953 standard

## Options

			CWC-180	CWC-300	CWC-600
UK Plug (G Type)	Cl		O	O	O
60Hz	60Hz		O	O	O

## Standard Accessories

			CWC-180	CWC-300	CWC-600
	19106526	EPOXY GRID CWC-180	pc	1	-
	19106524	EPOXY GRID CWC-300	pc	-	1
	19106525	EPOXY GRID CWC-300 45°	pc	-	3

## Optional Accessories

			CWC-180	CWC-300	CWC-600
	19045931	WOODEN GRID CWC-180	pc	1	-
	19097791	WOODEN GRID CWC-300	pc	-	1
	19097792	WOODEN GRID CWC-300 45°	pc	-	3

# Dry agers

Fagor Meat Dry Ager, with a refrigeration circuit designed with its own technology, guarantees a homogeneous distribution of both temperature and interior humidity, essential to obtain maximum quality results in the maturation process, whose results have been verified by BCC Innovation, Basque Culinary Center technological center.



## General characteristics

- Interior compartment completely built with AISI-304 stainless steel.
- Exterior finishing available in 2 finishings:
  - AISI-304 Stainless steel
  - Black coated Steel (B)
- Black coated Stainless steel base available for FMA-1650 models (S)
- 60 mm thickness, CFC-free, high-density (40 kg/m³) polyurethane insulation, injected under high pressure.
- Intuitive, large digital display for electronic control with energy saving function to ensure an optimal control of storing products.
- 10 HACCP alarms capacity which are store when high temperature variation and devices power failure.
- Double-glazed doors insulated with low thermal emissivity to reduce heat transfer in refrigeration.
- UV air sterilization lamp to prevent bacterial proliferation inside the compartment
- Two adjustable front feet and four rear rollers, allowing it to be transported easily.
- Removable and height adjustable epoxy coated grids with a maximum loading capacity of up to 40 kg.
- Meat hanging bar with a maximum loading capacity of up to 80 kg available under request
- Electric connection 220V-240V 1N

## Technical data

REFERENCE	MODEL	FREQUENCY	TEMPERATURE	GAS	COOLING POWER	ELECTRIC POWER	DEFROST	GROSS VOLUME (L)	DIMENSIONS	€
19073881	FMA-900	50Hz	+1°C +20°C	R-600a	0,169 (1)	0,169	ELECTRIC	149	620 x 600 x 925	-
19073882	FMA-900 B	50Hz	+1°C +20°C	R-600a	0,169 (1)	0,169	ELECTRIC	149	620 x 600 x 925	-
19073883	FMA-1650	50Hz	+1°C +20°C	R-600a	0,296 (1)	0,296	ELECTRIC	493	700 x 750 x 1665	-
19073884	FMA-1650 B	50Hz	+1°C +20°C	R-600a	0,296 (1)	0,296	ELECTRIC	493	700 x 750 x 1665	-
19081264	FMA-1650 S	50Hz	+1°C +20°C	R-600a	0,296 (1)	0,296	ELECTRIC	493	700 x 750 x 2050	-
19081265	FMA-1650 BS	50Hz	+1°C +20°C	R-600a	0,296 (1)	0,296	ELECTRIC	493	700 x 750 x 2050	-

(1) Evap. -10°C/ Cond. 45°C







## Options

			FMA-900	FMA-1650
UK Plug (G Type)	Cl		O	O
60Hz	60Hz		O	O

## Standard Accessories

			FMA-900	FMA-1650
	19097799	Epoxy grid 482x368mm	pc	1
	19097804	Epoxy grid 487x582mm	pc	-
	19097802	Epoxy grid 467x277x62,5mm	pc	1
	19097803	Epoxy grid 558x413x62,5mm	pc	-
	19097798	HIMALAYAN SALT BLOCK	pc	2
	19097801	SALT BLOCK SUPPORT FMA-1650	pc	1
	19097800	SALT BLOCK SUPPORT FMA-900	pc	1

# Accessories

PICTURE	MODEL	REFERENCE	DESCRIPTION	WHERE USED	€
<b>GRIDS</b>					
	EG-1650I	19097804	EPOXY GRID 487X582MM	FMA-1650	-
	EG-1650	19097799	EPOXY GRID 482x368MM	FMA-900	-
	EG-900	19097803	EPOXY GRID 558X413X62,5MM	FMA-1650	-
	EG-900I	19097802	EPOXY GRID 467X277X62,5MM	FMA-900	-
	KEG-1650	19081971	KIT ELECTROPOLISHED GRIDS	FMA-1650	-
	KEG-900	19081972	KIT ELECTROPOLISHED GRIDS	FMA-900	-
<b>HIMALAYAN SALT BLOCK</b>					
	HMS	19097798	HIMALAYAN SALT BLOCK	FMA	-
	HMSS-900	19097801	SALT BLOCK SUPPORT	FMA-1650	-
	HMSS-1650	19097800	SALT BLOCK SUPPORT	FMA-900	-
<b>BAR</b>					
	MHB-1650	19074041	KIT HANGIN BAR + HOOK	FMA-1650	-
	MHB-900	19074042	KIT HANGIN BAR + HOOK	FMA-900	-
<b>BASES</b>					
	B1650	19074043	BLACK COATED BASE	FMA-1650	-
	B900	19081970	BLACK COATED BASE	FMA-900	-







# Ice makers

— Solid ice-cube makers.....	<b>367</b>
— Dice-shaped ice-cube makers	<b>369</b>
— Granular ice makers .....	<b>371</b>
— Nugget ice makers .....	<b>373</b>
— Flake ice makers .....	<b>373</b>
— Hollow ice-cube makers .....	<b>374</b>
— Tanks for modular .....	<b>375</b>
— Accessories .....	<b>376</b>

Special units or any variations from the standard model must be assembled at the factory at an additional charge over the standard model's price.

Please, contact Fagor Professional for any other variation or option that is not included on this list.

The minimum recommended water quality is 15 to 40°F.



WITH BUILT-IN TANK

## Solid ice-cube makers



## General characteristics

- Produces solid gourmet crystal clear ice cubes.
- Spray system with flexible nozzles that avoid limescale deposits with small vibrations.
- Smart front ventilation system that allows built-in installation of the unit.
- Motor pump without seals, which avoids deterioration in hard water.
- Door opening movement with damping system to avoid accidents.
- On/off lighted rocker switch in front panel.
- Specially manufactured from high quality stainless steel for intensive professional applications, featuring a very robust design and perfect finish.
- The installation of an anti-scale filter is advised in areas with medium or high limescale content (hard water), over 30 °f of hardness.
- Equipment prepared for extreme ambient temperatures (43 °C).
- Electric connection 220V-240V 50Hz 1N. For other voltages and frequencies, consult the manufacturer.

## Technical data

REFERENCE	MODEL	CONDENSATION SYSTEM	GAS	TANK CAPACITY (KG)	PRODUCTION (KG/DAY)	N° CUBES PER CYCLE	POWER (W)	DIMENSIONS (MM)	€
L shaped cubes (14 gr)									
19107214	EFIM-20 L	Air	R290	6	22	18	862	350x475x595	-
19107215	EFIM-20 L	Water	R290	6	23	18	862	350x475x595	-
S shaped cubes (22 gr)									
19107216	EFIM-30 S	Air	R290	15	33	24	837	435x605x695	-
19107217	EFIM-30 S	Water	R290	15	37	24	837	435x605x695	-
19107218	EFIM-40 S	Air	R290	15	40	24	1266	435x605x695	-
19107219	EFIM-40 S	Water	R290	15	44	24	1266	435x605x695	-
19107220	EFIM-60 S	Air	R290	30	52	36	1266	515x645x840	-
19107221	EFIM-60 S	Water	R290	30	53	36	1266	515x645x840	-
19107222	EFIM-80 S	Air	R290	40	79	48	1967	645x645x870	-
19107223	EFIM-80 S	Water	R290	40	81	48	1967	645x645x870	-
19107224	EFIM-130 S	Air	R290	60	113	72	2292	930x565x915	-
19107235	EFIM-130 S	Water	R290	60	121	72	2292	930x565x915	-
K shaped cubes (40 gr)									
19107225	EFIM-30 K	Air	R290	15	33	24	975	435x605x695	-
19107226	EFIM-30 K	Water	R290	15	37	24	975	435x605x695	-
19107227	EFIM-40 K	Air	R290	15	40	24	1266	435x605x695	-
19107228	EFIM-40 K	Water	R290	15	44	24	1266	435x605x695	-
19107229	EFIM-60 K	Air	R290	30	52	36	1266	515x645x840	-
19107230	EFIM-60 K	Water	R290	30	53	36	1266	515x645x840	-
19107231	EFIM-80 K	Air	R290	40	79	48	1967	645x645x870	-
19107232	EFIM-80 K	Water	R290	40	81	48	1967	645x645x870	-
19107233	EFIM-130 K	Air	R290	60	113	72	2292	930x565x915	-
19107234	EFIM-130 K	Water	R290	60	121	72	2292	930x565x915	-

## Options

MODEL	60HZ	UK	DP
EFIM-20	0	0	-
EFIM-30	0	0	0
EFIM-40	0	0	0
EFIM-60	0	0	0
EFIM-80	0	0	0
EFIM-130	0	0	0

## Standard Accessories

MODEL	WATER INLET FILTER GASKET	WATER INLET HOSE	WATER OUTLET HOSE	SMALL SCOOP	4 LEG KIT
EFIM-20	1	1	1	1	-
EFIM-30	1	1	1	1	1
EFIM-40	1	1	1	1	1
EFIM-60	1	1	1	1	1
EFIM-80	1	1	1	1	1
EFIM-130	1	1	1	1	1

MODULAR

## Solid ice-cube makers



## General characteristics

- Produces solid gourmet crystal clear ice cubes.
- Spray system with flexible nozzles that avoid limescale deposits with small vibrations.
- High efficiency machines with low electrical consumption.
- Stackable machines. Connection kit accessory required.
- Specially manufactured from high quality stainless steel for intensive professional applications, featuring a very robust design and perfect finish.
- The installation of an anti-scale filter is advised in areas with medium or high limescale content (hard water), over 30 °f of hardness.
- Electric connection 220V-240V 50Hz 1N. For other voltages and frequencies, consult the manufacturer.

## Technical data

REFERENCE	MODEL	CONDENSATION SYSTEM	GAS	TANK CAPACITY (KG)	PRODUCTION (KG/DAY)	N° CUBES PER CYCLE	POWER (W)	DIMENSIONS (MM)	€
S shaped cubes (22 gr)									
19107236	EMFIM-150 S	Air	R290	-	154	96	3610	775x625x805	-
19107239	EMFIM-150 S	Water	R290	-	154	96	3610	775x625x805	-
19107018	MFIM-400 S	Air	R-452a	-	390	192	13500	1321x638x978	-
19107032	MFIM-400 S	Water	R-452a	-	400	192	13500	1321x638x978	-
K shaped cubes (40 gr)									
19107237	EMFIM-150 K	Air	R290	-	154	96	3610	775x625x805	-
19107238	EMFIM-150 K	Water	R290	-	154	96	3610	775x625x805	-
19107019	MFIM-400 K	Air	R-452a	-	390	192	13500	1321x638x978	-
19107031	MFIM-400 K	Water	R-452a	-	400	192	13500	1321x638x978	-

## Compatible tanks

MODEL CAPACITY	S-130 160 KG CODE		S-160 180 KG CODE		S-220 230 KG CODE		S-350 340 KG CODE	
	€	€	€	€	€	€		
EMFIM-150	19082415	-	-	-	19031799	-	19082418	-
MFIM-400	-	-	-	-	-	-	-	-
MODEL CAPACITY	39,36 390 KG CODE		S-500 480 KG CODE		S CART 300 + 112 KG CODE		S2CART 617 + 224 KG CODE	
	€	€	€	€	€	€		
EMFIM-150	19096225	-	19031802	-	19082382	-	19082384	-
MFIM-400	19096225	-	19031802	-	-	-	-	-

## Options

MODEL	60HZ	UK	DP
EMFIM-150	0	0	-
MFIM-400	0	-	-

## Standard Accessories

MODEL	WATER INLET FILTER GASKET	WATER INLET HOSE	WATER OUTLET HOSE	SMALL SCOOP
EMFIM-150	1	1	1	1
MFIM-400	1	1	1	-

# Dice-shaped ice-cube makers



## General characteristics

- Produces full dice ice cubes or half dice ice cubes.
- Easy access for service and installation. All panels can be disassembled separately.
- Strong door opening system. Door made in stainless steel.
- Smart front ventilation system that allows built-in installation of the unit.
- On/off lighted rocker switch in front panel.
- Cleaning switch that allows circulation of water with descaling product without cooling.
- Electronic control that enhances the performance of the machine and allows it to adapt to extreme climates.
- Specially manufactured from high quality stainless steel for intensive professional applications, featuring a very robust design and perfect finish.
- Equipment prepared for extreme ambient temperatures (43 °C).
- Height adjustable legs from 105 mm to 155 mm.
- Electric connection 220V-240V 50Hz 1N. For other voltages and frequencies, consult the manufacturer.



HD



D

## Technical data

									€
HD shaped cubes (6 gr)									
19107202	EFICE-50 HD	Air	R290	20	47	75	770	535x595x789	-
19107203	EFICE-70 HD	Air	R290	20	74	75	1007	535x595x789	-
19107204	EFICE-100 HD	Air	R290	35	108	120	1154	660x700x832	-
19107205	EFICE-150 HD	Air	R290	45	145	144	1868	762x762x832	-
D shaped cubes (12 gr)									
19107208	EFICE-50 D	Air	R290	20	45	75	770	535x595x789	-
19107209	EFICE-70 D	Air	R290	20	76	75	1007	535x595x789	-
19107210	EFICE-100 D	Air	R290	35	99	120	1154	660x700x832	-
19107211	EFICE-150 D	Air	R290	45	145	144	1868	762x762x832	-

## Options

MODEL	60HZ	UK	DP
EFICE-50	0	0	0
EFICE-70	0	0	0
EFICE-100	0	0	0
EFICE-150	0	0	0

## Standard Accessories

MODEL	WATER INLET FILTER GASKET	WATER INLET HOSE	WATER OUTLET HOSE	SMALL SCOOP	4 LEG KIT (ADJUSTABLE HEIGHT)
EFICE-50	1	1	1	1	1
EFICE-70	1	1	1	1	1
EFICE-100	1	1	1	1	1
EFICE-150	1	1	1	1	1

## MODULAR

# Dice-shaped ice-cube makers



## General characteristics

- Produces full dice ice cubes or half dice ice cubes.
- High evaporator efficiency. Lower energy consumption and higher ice production.
- Smart water distributor that improves drop-off efficiency.
- Easy access by removing the panels with a single screwdriver.
- Smart electronic board that controls every parameter in the machine and shows the diagnosis of possible incidences.
- Specially manufactured from high quality stainless steel for intensive professional applications, featuring a very robust design and perfect finish.
- Electric connection 220V-240V 50Hz 1N (except for FICE-400, 380V-415V 50Hz 3N). For other voltages and frequencies, consult the manufacturer.



HD



D

## Technical data

REFERENCE	MODEL	CONDENSATION SYSTEM	GAS	TANK CAPACITY (KG)	PRODUCTION (KG/DAY)	N° CUBES PER CYCLE	POWER (W)	DIMENSIONS (MM)	€
HD shaped cubes (6 gr)									
19107206	EFICE-200 HD	Air	R290	-	220	400	1868	762x620x500	-
19107207	EFICE-300 HD FIT	Air	R290	-	300	480	2348	559x621x659	-
19107015	FICE-400 HD*	Air	R-452a	-	405	800	11185	762x620x760	-
D shaped cubes (12 gr)									
19107212	EFICE-200 D	Air	R290	-	220	200	1868	762x620x500	-
19107213	EFICE-300 D FIT	Air	R290	-	300	240	2348	559x621x659	-
19107016	FICE-400 D*	Air	R-452a	-	405	400	11185	762x620x760	-

\*Electric connection 380V-415V 50Hz 3N. For other voltages and frequencies, consult the manufacturer.

## Compatible tanks

MODEL CAPACITY	S-130 160 KG		S-160 180 KG		S-220 230 KG		S-350 340 KG		
	CODE	€	CODE	€	CODE	€	CODE	€	
EFICE-200		19082415	-	-		19031799	-	19082418	-
EFICE-300		19082415	-	19082417	-	19031799	-	19082418	-
FICE-400		19082415	-	-	-	19031799	-	19082418	-
MODEL CAPACITY	S-400 390 KG		S-500 480 KG		S-CART 300 + 112 KG		S2CART 617 + 224 KG		
	CODE	€	CODE	€	CODE	€	CODE	€	
EFICE-200		19096225	-	19031802	-	19082382	-	19082385	-
EFICE-300		19096225	-	19031802	-	19082382	-	19082385	-
FICE-400		19096225	-	19031802	-	19082382	-	19082385	-



CODE	MODEL	SUITABLE FOR	CAPACITY	DIMENSIONS (MM)	€
19031818	Dispenser DHD	EFICE-200 FICE-400	104	769x835x1383	-
19082463	Dispenser DHD FIT & WATER	EFICE-300	58	559x835x1218	-

## Options

MODEL	60HZ	UK	DP
EFICE-200	0	0	-
EFICE-300	0	0	-
FICE-400	0	0	-

## Standard Accessories

MODEL	WATER INLET FILTER GASKET	WATER INLET HOSE	WATER OUTLET HOSE
EFICE-200	1	1	1
EFICE-300	1	1	1
FICE-400	1	1	1

# Granular ice-cube makers



- Granular ice production.
- High efficient evaporator, without gaskets or seals.
- Stainless steel auger with resilient coating to maximize lifespan.
- Powerful speed reducer on top.
- Easy access for service and installation. All panels can be disassembled separately.
- Strong door opening system. Door made in stainless steel.
- Smart front ventilation system that allows built-in installation of the unit.
- On/off lighted rocker switch in front panel.
- Cleaning switch: disconnects the cooling system while circulating water with descaling product.
- Specially manufactured from high quality stainless steel for intensive professional applications, featuring a very robust design and perfect finish.
- Equipment prepared for extreme ambient temperatures (43 °C).
- The installation of an anti-scale filter is advised in areas with medium or high limescale content (hard water), over 30 °f of hardness.
- Height adjustable legs from 105 mm to 155 mm.
- Electric connection 220V-240V 50Hz 1N. For other voltages and frequencies, consult the manufacturer.

## Technical data

REFERENCE	MODEL	CONDENSATION SYSTEM	GAS	TANK CAPACITY (KG)	PRODUCTION (KG/DAY)	N° CUBES PER CYCLE	POWER (W)	DIMENSIONS (MM)	€
19107174	EGIM-45	Air	R290	20	55	-	679	465x595x784	-
19107182	EGIM-45	Water	R290	20	78	-	679	465x595x784	-
19107175	EGIM-85	Air	R290	20	95	-	758	465x595x784	-
19107177	EGIM-85	Water	R290	20	95	-	758	465x595x784	-
19107176	EGIM-135	Air	R290	64	178	-	1267	515x550x1355	-
19107185	EGIM-135	Water	R290	64	202	-	1267	515x550x1355	-

## Options

MODEL	60HZ	UK	DP
EGIM-45	0	0	-
EGIM-85	0	0	-
EGIM-135	0	0	-

## Standard Accessories

MODEL	WATER INLET FILTER GASKET	WATER INLET HOSE	WATER OUTLET HOSE	SMALL SCOOP	KIT DE 4 PATAS (ALTURA AJUSTABLE)
EGIM-45	1	1	1	1	1
EGIM-85	1	1	1	1	1
EGIM-135	1	1	1	1	-

## MODULAR

# Granular ice-cube makers



## General characteristics

- Granular ice production.
- Ice drops out through the opening on the bottom of the unit.
- High efficient evaporator, without gaskets or seals.
- Stainless steel auger with resilient coating to maximize lifespan.
- Powerful speed reducer on top.
- Electromechanical control system.
- On/off lighted rocker switch in the front panel.
- Specially manufactured from high quality stainless steel for intensive professional applications, featuring a very robust design and perfect finish.
- The installation of an anti-scale filter is advised in areas with medium or high limescale content (hard water), over 30 °f of hardness.
- Equipment prepared for extreme ambient temperatures (43 °C).
- Electric connection 220V-240V 50Hz 1N (except for EMGIM-500, 380V-415V 50Hz 3N). For other voltages and frequencies, consult the manufacturer.

## Technical data

MODEL	REF	REF	REF	REF	REF	REF	REF	REF	REF	€
19107178	EMGIM-150	Air	R290	-	182	-	1266	515x550x1355	-	-
19107183	EMGIM-150	Water	R290	-	202	-	1266	515x550x1355	-	-
19107179	EMGIM-200	Air	R290	-	230	-	1651	515x550x575	-	-
19107189	EMGIM-200	Water	R290	-	211	-	1651	515x550x575	-	-
19107180	EMGIM-400	Air	R290	-	482	-	3620	675x550x660	-	-
19107186	EMGIM-400	Water	R290	-	541	-	3620	675x550x660	-	-
19107273	EMGIM-500*	Air	R290	-	655	-	5218	675x550x800	-	-
19107276	EMGIM-500*	Water	R290	-	620	-	5218	675x550x800	-	-

\*Electric connection 380V-415V 50Hz 3N. For other voltages and frequencies, consult the manufacturer.

## Compatible tanks

MODEL CAPACITY	S-130 160 KG CODE	€	S-160 180 KG CODE	€	S-220 230 KG CODE	€	S-350 340 KG CODE	€
EMGIM-150	19082414	-	19082416	-	19031843	-	19082374	-
EMGIM-200	19082414	-	19082416	-	19031843	-	19082374	-
EMGIM-400	19082414	-	19082416	-	19031843	-	19082374	-
EMGIM-500	19082414	-	19082416	-	19031843	-	19082374	-

MODEL CAPACITY	39,36 390 KG CODE	€	S-500 480 KG CODE	€	S CART 300 + 112 KG CODE	€	S2CART 617 + 224 KG CODE	€
EMGIM-150	19096224	-	19031844	-	19082380	-	19082383	-
EMGIM-200	19096224	-	19031844	-	19082380	-	19082383	-
EMGIM-400	19096224	-	19031844	-	19082380	-	19082383	-
EMGIM-500	19096224	-	19031844	-	19082380	-	19082383	-

## Options

MODEL	60 FREQUENCY	UK	DP
EMGIM-150	0	0	-
EMGIM-200	0	0	-
EMGIM-400	0	0	-
EMGIM-500	0	-	-

## Standard Accessories

MODEL	WATER INLET FILTER GASKET	WATER INLET HOSE	WATER OUTLET HOSE
EMGIM-150	1	1	1
EMGIM-200	1	1	1
EMGIM-400	1	1	1
EMGIM-500	1	1	1

MODULAR

# Nugget ice-cube makers



N

- Nugget ice production.
- Ice drops out through the opening on the bottom of the unit.
- High evaporator efficiency. Lower energy consumption and higher ice production.
- Stainless steel auger with resilient coating to maximize lifespan.
- Powerful speed reducer on top.
- Optical pinpoint control system to set ice stock level.
- On/off lighted rocker switch in the front panel.
- Autodiagnosis led lights signaling operation status & alerts.
- Specially manufactured from high quality stainless steel for intensive professional applications, featuring a very robust design and perfect finish.
- The installation of an anti-scale filter is advised in areas with medium or high limescale content (hard water), over 30 °f of hardness.
- Equipment prepared for extreme ambient temperatures (43 °C).
- Electric connection 220V-240V 50Hz 1N. For other voltages and frequencies, consult the manufacturer.

### Technical data

REFERENCE	MODEL	CONDENSATION SYSTEM	GAS	TANK CAPACITY (KG)	PRODUCTION (KG/DAY)	N° CUBES PER CYCLE	POWER (W)	DIMENSIONS (MM)	€
19107190	ENGIM-300	Air	R290	-	310	-	3240	559x622x712	-

### Options

MODEL	60HZ	UK	DP
ENGIM-300	0	0	-

### Standard Accessories

MODEL	60HZ	UK	DP
ENGIM-300	1	1	1

### Compatible tanks

MODEL/CAPACITY	S-130/ 160 KG CODE	€	S-160/ 180 KG CODE	€	S-220/ 230 KG CODE	€	S-350/ 340 KG CODE	€
ENGIM-300	19082414	-	19082416	-	19031843	-	19082374	-
	39,36/ 390 KG CODE	-	S-500/ 480 KG CODE	-	S CART/ 300 + 112 KG CODE	-	S2CART/ 617 + 224 KG CODE	-
ENGIM-300	19096224	-	19031844	-	19082380	-	19082383	-

# Flake ice-cube makers



F

### General characteristics

- Cold and dry flat flakes production. Flake thickness may be adjusted between 1.5 mm and 3 mm.
- Based on a static cylinder which is free from swivel joints (helical reamer) coupled with a milling tool that detaches the ice without any strained or forced movements.
- High evaporator efficiency. Lower energy consumption and higher ice production.
- Powerful speed reducer on top.
- Magnetic drive pump.
- Electronic stop system.
- Controllers to detect: low water level, temperature rise due to motor overload or full vat.
- Specially manufactured from high quality stainless steel for intensive professional applications
- Electric connection 380V-415V 50Hz 3N. For other voltages and frequencies, consult the manufacturer.

### Technical data

REFERENCE	MODEL	CONDENSATION SYSTEM	GAS	TANK CAPACITY (KG)	PRODUCTION (KG/DAY)	N° CUBES PER CYCLE	POWER (W)	DIMENSIONS (MM)	€
19082465	FLAKE 1000*	Air	R-452a	-	1000	-	5500	1340x1150x870	-

\*Electric connection 380V-415V 50Hz 3N. For other voltages and frequencies, consult the manufacturer.

### Options

MODEL	60HZ	UK	DP
FLAKE 1000	0	-	-

### Standard Accessories

MODEL	WATER INLET FILTER GASKET	WATER INLET HOSE	WATER OUTLET HOSE
FLAKE 1000	1	1	1

### Compatible tanks

MODEL/CAPACITY	39,36/ 390 KG CODE	€	S-500/ 480 KG CODE	€	S CART/ 300 + 112 KG CODE	€	S2CART/ 617 + 224 KG CODE	€
FLAKE 1000	-	-	-	-	-	-	19082383	-

# Hollow ice-cube makers



C

### General characteristics

- Produces a semi-hollow cube with a greater surface that cools faster the drink.
- Paddle system to produce ice in the most adverse conditions of water quality (hardwater) and in the least adequate sites.
- Paddle system that makes water filters unnecessary, avoiding their costs.
- Water movement thanks to paddles grants that the purest water touches the evaporator and get frozen, obtaining the clearest ice cube.
- Designed without thermostat, avoiding problems & getting all ice is possible.
- Without timer. Detection of end of cycle and full bin are detected through mechanical devices.
- Door-opening movement dampening system to avoid accidents.
- On/off lighted rocker switch in front panel.
- Specially manufactured from high quality stainless steel for intensive professional applications, featuring a very robust design and perfect finish.
- Equipment prepared for extreme ambient temperatures (43 °C).
- Electric connection 220V-240V 50Hz 1N. For other voltages and frequencies, consult the manufacturer.

### Technical data

REFERENCE	MODEL	CONDENSATION SYSTEM	GAS	TANK CAPACITY (KG)	PRODUCTION (KG/DAY)	N° CUBES PER CYCLE	POWER (W)	DIMENSIONS (MM)	€
C shaped cubes (20 gr)									
19107192	EFIM-20 C	Air	R290	6	24	15	778	401x506x643	-
19107193	EFIM-20 C	Water	R290	6	24	15	778	401x506x643	-
19107194	EFIM-30 C	Air	R290	12	38	25	778	401x506x698	-
19107195	EFIM-30 C	Water	R290	12	38	25	778	401x506x698	-
19107196	EFIM-40 C	Air	R290	12	40	25	404	401x506x698	-
19107197	EFIM-40 C	Water	R290	12	40	25	404	401x506x698	-
19107198	EFIM-60 C	Air	R290	30	63	45	1266	594x557x934	-
19107199	EFIM-60 C	Water	R290	30	66	45	1266	594x557x934	-
19107200	EFIM-90 C	Air	R290	37	83	55	1804	674x557x984	-
19107191	EFIM-90 C	Water	R290	37	83	55	1804	674x557x984	-
19107201	EFIM-130 C	Air	R290	50	119	80	2292	844x557x984	-
19107240	EFIM-130 C	Water	R290	50	114	80	2292	844x557x984	-

### Options

MODEL	60HZ	UK	DP
EFIM-20	0	0	-
EFIM-30	0	0	-
EFIM-40	0	0	-
EFIM-60	0	0	-
EFIM-90	0	0	-
EFIM-130	0	0	-

### Standard Accessories

MODEL	WATER INLET FILTER GASKET	WATER INLET HOSE	WATER OUTLET HOSE	SMALL SCOOP	KIT DE 4 PATAS (ALTURA AJUSTABLE)
EFIM-20	1	1	1	1	-
EFIM-30	1	1	1	1	1
EFIM-40	1	1	1	1	1
EFIM-60	1	1	1	1	1
EFIM-90	1	1	1	1	1
EFIM-130	1	1	1	1	1



## Tanks for modular ice-cube makers (Silos)



### General characteristics

- Specially manufactured from high quality stainless steel for intensive professional applications, featuring a very robust design and perfect finish.
- Very hard sanitary polyethylene vat, resistant to blows, and scratches.
- Seamless one-piece vat with rounded corners, avoiding possible dirty points and facilitating cleaning.
- Drainage system that collects and drives the water to the drain keeping the bin clean and dry.

### Specific features: Tanks with trolley

- Ergonomic, easy to move with little effort.
- It has a braking and drainage system.
- Made of sanitary polyethylene, with smooth surface to facilitate cleaning.
- Includes a cover to prevent dirt from contaminating the ice.
- Buckets for distributing ice quickly and effortlessly can be included.





### Technical data

MODEL	SUITABLE FOR	REFERENCE	TANK CAPACITY (KG)	DIMENSIONS (MM)	€
<b>Tanks</b>					
S-130	FICE	19082415	160	762x819x740	-
	MGIM / NGIM	19082414			
S-160	FICE	19082417	180	559x872x1122	-
	MGIM / NGIM	19082416			
S-220	MFIM / FICE	19031799	230	762x819x1071	-
	MGIM / NGIM	19031843			
S-350	MFIM / FICE	19082418	340	1067x819x1071	-
	MGIM	19082374			
S-400	MFIM / FICE	19096225	390	1219x819x1071	-
	S400 MGIM	19096224			
S-500	MFIM / FICE	19031802	480	1321x872x1122	-
	MGIM	19031844			
<b>Tanks with trolley</b>					
SCART	MFIM / FICE	19082382	300+112	762x1016x1865	-
	MGIM / NGIM	19082380			
S2CART	MFIM	19082384	617+224	1524x1016x1820	-
	FICE	19082385			
	MGIM / NGIM	19082383			

### Standard Accessories

MODEL	WATER OUTLET HOSE	CODO DE DESAGÜE	LARGE SCOOP	*4 LEG KIT (ADJUSTABLE HEIGHT)	ICE PADDLE	ICE PADDLE SUPPORT
Tanks	1	1	1	1	-	-
Tanks with trolley	1	-	1	-	1	1

## Accessories

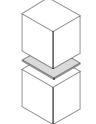
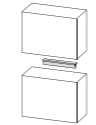
REFERENCE	MODEL	DESCRIPTION	€	
<b>Filters</b>				
	19038797	FC-100	Lime scale filter	-
	19038798	FP-100	Particles filter	-
	19038799	CC-100	Spare part	-
	19038800	CP-100	Spare cartridge particles	-
	19031839	CS-101	Anti-scale/active carbon/particulate filter	-
	19082428	CS-102	Anti-scale/active carbon/particulate filter	-
<b>Shovels</b>				
	19082429	SMALL SHOVEL	Small shovel	-
	19082462	MEDIUM SHOVEL	Medium shovel	-
<b>Stacking kits</b>				
	19082425	STACKING KIT EMFIM 150	Stacking kit	-
	19082426	STACKING KIT MFIM 400	Stacking kit	-
	19082427	STACKING KIT FICE	Stacking kit	-
<b>Crusher</b>				
	19082464	ICE CRUSHER	Crusher	-





Distribution





Make your designs come true with the widest range.



Acceso a la web

# Drop-in

- Refrigerated elements..... **381**
- Hot elements..... **384**
- Cold-hot mixed elements..... **388**
- Foodshields..... **389**
- Glasses..... **390**
- Cubic refrigerated vitrines..... **391**
- Cubic hot vitrines ..... **393**
- Reserves ..... **394**
- Dispensers ..... **395**
- Accesories..... **395**
- Remote codes..... **396**

ADVANCE

# Refrigerated elements

## General characteristics

- Manufactured in stainless steel with satin finish.
- Wells with rounded corners inside to make cleaning operations easier, ensuring maximum hygiene.
- Polyurethane insulation with ecological injection, allowing energy savings by reducing loss of cold air.

- Control panel with digital thermostat, protected by the structure perimeter, avoiding hindrances in their daily use.
- Robust structure with 13 mm thick overlap, once element is dropped-in on the worktop, ensuring cleanness and aesthetics.
- Automatic evaporation system of defrost water as an accessory.
- 220-240V 1N~.

## STATIC PLATES AND WELLS

- Specially designed to hold, display and serve chilled food (e.g. fruits, salads, etc.) and beverages (e.g. bottles or tall cans, etc.) keeping displayed product at optimum temperatures during service time.
- Static refrigeration system by expanded copper coil located in its base and also on the sides of the 160mm depth well to improve performance.

- Fresh product showcase well with glass dome specially designed to hold the temperature and display fresh products (e.g. meat, fish, shellfish, etc.) so that these are selected by a guest and prepared by a chef in show-cooking stations.
- Working temperatures: -10°C/ +5°C (160 mm well: 0°C/ +8°C).



	MODEL	GAS	HZ	CODE	DIMENSIONS (mm)	CUT-OUT DIMENSIONS (mm)	WELL DEPTH (mm)	CAPACITY GN 1/1	POWER (W)	CLIMATIC CLASS	COLD GROUP	€
<b>1 LEVEL STATIC PLATE</b>												
	DDCSP6-2	R290	50/60	19105747	790x610x476	765x585	-	2	145	4	Included	-
	DDCSP6-3	R290	50/60	19105748	1115x610x476	1090x585	-	3	215	4	Included	-
	DDCSP6-4	R290	50/60	19105749	1440x610x476	1415x585	-	4	225	4	Included	-
	DDCSP6-5	R290	50/60	19105750	1765x610x476	1740x585	-	5	305	4	Included	-
	DDCSP6-6	R290	50/60	19105751	2090x610x476	2065x585	-	6	330	4	Included	-
<b>2 LEVELS STATIC PLATE</b>												
	DDCS2P6-3	R290	50/60	19105757	1115x610x546	1090x585	-	3	215	4	Included	-
	DDCS2P6-4	R290	50/60	19105758	1440x610x546	1415x585	-	4	225	4	Included	-
	DDCS2P6-5	R290	50/60	19105759	1765x610x546	1740x585	-	5	305	4	Included	-
<b>STATIC 80 mm WELL</b>												
	DDCSB6-80-3	R290	50/60	19105763	1115x610x521	1090x585	80	3	215	4	Included	-
	DDCSB6-80-4	R290	50/60	19105764	1440x610x521	1415x585	80	4	225	4	Included	-
	DDCSB6-80-5	R290	50/60	19105765	1765x610x521	1740x585	80	5	305	4	Included	-
<b>STATIC 160 mm WELL</b>												
	DDCSB6-160-2	R290	50/60	19105769	790x610x632	765x585	160	2	135	4	Included	-
	DDCSB6-160-3	R290	50/60	19105770	1115x610x632	1090x585	160	3	215	4	Included	-
	DDCSB6-160-4	R290	50/60	19105771	1440x610x632	1415x585	160	4	220	4	Included	-
	DDCSB6-160-5	R290	50/60	19105772	1765x610x632	1740x585	160	5	305	4	Included	-
	DDCSB6-160-6	R290	50/60	19105773	2090x610x632	2065x585	160	6	310	4	Included	-
<b>FRESH PRODUCT SHOWCASE WELL</b>												
	DDCE6-80-1	R290	50/60	19105779	487x621x817	440x585	80	1	140	4	Included	-
	DDCE6-80-2	R290	50/60	19105780	812x621x817	765x585	80	2	145	4	Included	-

Check remote versions at the end of the chapter.

## UNDERCOUNTER PLATE

- Specially designed to be mounted under a countertop, keeping pre-chilled products at optimum temperatures during service time.
- Static refrigeration system by expanded copper coil located in its base.
- Working temperatures: -25°C/ -10°C.



FPBCF-4

	MODEL	GAS	HZ	CODE	DIMENSIONS (mm)	CAPACITY GN 1/1	POWER (W)	CLIMATIC CLASS	COLD GROUP	€
	FPBCF-2	R290	50/60	19092125	611x590x477	2	205	4	Included	-
	FPBCF-3	R290	50/60	19092126	936x590x477	3	270	4	Included	-
	FPBCF-4	R290	50	19092127	1261x590x477	4	390	4	Included	-
	FPBCF-5	R290	50	19106275	1586x590x477	5	455	4	Included	-
	FPBCF-6	R290	50	19106276	1911x590x477	6	470	4	Included	-

Check remote versions at the end of the chapter.

## VENTILATED WELL

- Specially designed to hold, display and serve chilled food (e.g. fruits, desserts, yogurts, cold appetizers, presented on plates, ramekins or GN1/1-100mm etc.) keeping displayed product at optimum temperatures during service time.
- Air-blown cooling system generated by the evaporator fans, creating a gentle air curtain over the upper part of the well. Faster cool-down times, better air distribution and optimum results for food conservation are achieved.
- Automatic defrost system that minimizes compressor workload and saves energy.
- Working temperatures: 0°C/ +4°C.



FCRV7-4

	MODEL	GAS	HZ	CODE	DIMENSIONS (mm)	CUT-OUT DIMENSIONS (mm)	WELL DEPTH (mm)	CAPACITY GN 1/1	POWER (W)	CLIMATIC CLASS	COLD GROUP	€
	FCRV7-2	R290	50/60	19091732	790x720x677	765x690	35- 82-120	2	235	4	Included	-
	FCRV7-3	R290	50/60	19091733	1115x720x677	1090x690	35- 82-120	3	375	4	Included	-
	FCRV7-4	R290	50/60	19091734	1440x720x677	1415x690	35- 82-120	4	380	4	Included	-
	FCRV7-5	R290	50	19091735	1765x720x677	1740x690	35- 82-120	5	485	4	Included	-
	FCRV7-6	R290	50	19091737	2090x720x677	2065x690	35- 82-120	6	510	4	Included	-

Check remote versions at the end of the chapter.





**WELL FOR FROZEN PRODUCTS**

- Specially designed to hold, display and serve frozen foods, particularly ice cream (packaged or in bulk), keeping displayed products at optimum temperatures during service time.
- These models are not designed to keep the frozen products for a period of time beyond a standard meal service (maximum duration of 3 to 4 hours).
- Working temperatures: -20°C/ -14°C.



DDCF6-4

MODEL	GAS	HZ	CODE	DIMENSIONS (mm)	CUT-OUT DIMENSIONS (mm)	WELL DEPTH (mm)	CAPACITY 360X165	POWER (W)	CLIMATIC CLASS	COLD GROUP	€
 DDCF6-4	R290	50/60	19106273	835x610x678	810x585	235	4	185	4	Included	-
 ICLP	-	-	19081905	270x110x145	260x100	DIPPER WELL					-

Check remote versions at the end of the chapter.

**NEUTRAL WELL AND CHAMPAGNE STATION**

- Specially designed to hold, display and serve chilled foods (e.g. fruits, desserts, cold appetizers presented on plates or ramekins) or beverages also (smoothies, bottles) presented on ice during service time.

- Three (3) RGB LED lighting strips at the bottom of the well to ensure a homogeneous lighting. Radio frequency control for effect control, colour and brightness selection.
- Champagne station with 4 mm thick overlap, once element is dropped-in on the worktop, ensuring cleanness and aesthetics.





DDCI-120-4



CNH6-80-4



CHMP-450

MODEL	GAS	HZ	CODE	DIMENSIONS (mm)	CUT-OUT DIMENSIONS (mm)	WELL DEPTH (mm)	CAPACITY GN 1/1	POWER (W)	CLIMATIC CLASS	COLD GROUP	€
<b>NEUTRAL ICE WELL WITH LIGHT</b>											
 DDCI-120-4	-	50/60	19105958	1440x610x348	1415x585	120	4	60	-	-	-
<b>NEUTRAL ICE WELL</b>											
CNH6-80-2	-	-	19047624	790x610x122	765x585	80	2	-	-	-	-
CNH6-80-3	-	-	19047625	1115x610x122	1090x585	80	3	-	-	-	-
 CNH6-80-4	-	-	19047626	1440x610x122	1415x585	80	4	-	-	-	-
CNH6-80-5	-	-	19047627	1765x610x122	1740x585	80	5	-	-	-	-
CNH6-80-6	-	-	19047628	2090x610x122	2065x585	80	6	-	-	-	-
<b>NEUTRAL ICE WELL WITH LIGHT</b>											
 CHMP-450	-	50/60	19081572	Ø 610x470	Ø 585	310	-	30	-	-	-

**ICE-CREAM TEPPANYAKI**

- Specially designed to perform live preparations and serve cold desserts (e.g. rolled ice creams, crepes, sherbets, cocktails, chocolate) in front of the guest.
- Working temperatures: -35°C/ -20°C.



DDTPY6-2

MODEL	GAS	HZ	CODE	DIMENSIONS (mm)	CUT-OUT DIMENSIONS (mm)	WELL DEPTH (mm)	CAPACITY GN 1/1	POWER (W)	CLIMATIC CLASS	COLD GROUP	€
 DDTYP6-2	R290	50	19106277	790x610x634	765x585	30	2	695	4	Included	-

# Hot elements

**General characteristics**

- Manufactured in stainless steel with satin finish.
- Wells with rounded corners inside to make cleaning operations easier, ensuring maximum hygiene.
- Control panel with digital thermostat, protected by the structure perimeter, avoiding hindrances in their daily use.

- Robust structure with 13 mm thick overlap, once element is dropped-in on the worktop, ensuring cleanness and aesthetics.
- Foodshields with light and heat available as an accessory to improve temperature maintenance and increase conservation time on the surface of the food.
- 220-240V 1N~ 50/60Hz.

**HOT PLATE**

- Specially designed to hold, display and serve hot food presented on plates or shallow GN 1/1 pans (e.g. hot appetizers, sandwiches, pies, pizza, etc.) keeping displayed product at optimum temperatures during service time.

- Heating system by hidden silicon heaters attached to the bottom of the plate.
- Working temperatures: +30°C/ +100°C.

**Glass ceramic plate**

- 4 mm thickness, high-resistant, glass ceramic.



PV6-4



PV6-4-W

BLACK CERAMIC PLATE			WHITE CERAMIC PLATE			DIMENSIONS (mm)	CUT-OUT DIMENSIONS (mm)	CAPACITY GN 1/1	POWER (W)
MODEL	CODE	€	MODEL	CODE	€				
PV6-2	19043198	-	PV6-2-W	19043203	-	790x610x147	765x585	2	905
PV6-3	19043199	-	PV6-3-W	19043204	-	1115x610x147	1090x585	3	1355
 PV6-4	19043201	-	PV6-4-W	19043205	-	1440x610x147	1415x585	4	1805
PV6-5	19043202	-	PV6-5-W	19043206	-	1765x610x147	1740x585	5	2255
PV6-6	19047666	-	PV6-6-W	19047667	-	2090x610x147	2065x585	6	2710

**Tempered glass plate**

- 6 mm thickness, high-resistant, black tempered glass.
- Not recommended for depositing containers at temperatures above 180 °C.



DDHTP6-4

MODEL	CODE	DIMENSIONS (mm)	CUT-OUT DIMENSIONS (mm)	CAPACITY GN 1/1	COLOR	POWER (W)	€
 DDHTP6-2	19105742	790x610x147	765x585	2	Black	905	-
DDHTP6-3	19105743	1115x610x147	1090x585	3	Black	1355	-
DDHTP6-4	19105744	1440x610x147	1415x585	4	Black	1805	-
DDHTP6-5	19105745	1765x610x147	1740x585	5	Black	2255	-
DDHTP6-6	19105746	2090x610x147	2065x585	6	Black	2710	-

**Frameless glass ceramic plate**

- 4 mm thickness, high-resistant, glass ceramic.
- Flush-mount in the countertop, maximizing cleanliness and seamless aesthetic continuity.



PVE11-4

BLACK CERAMIC PLATE			WHITE CERAMIC PLATE			DIMENSIONS (mm)	CUT-OUT DIMENSIONS (mm)	CAPACITY GN 1/1	POWER (W)
MODEL	CODE	€	MODEL	CODE	€				
PVE11-2	19081562	-	PVE11-2-W	19081563	-	650x530x137	656x536	2	905
PVE11-3	19081564	-	PVE11-3-W	19081565	-	975x530x137	987x536	3	1355
 PVE11-4	19081566	-	PVE11-4-W	19081567	-	1300x530x137	1312x536	4	1805
PVE11-5	19081568	-	PVE11-5-W	19081569	-	1625x530x137	1631x536	5	2255
PVE11-6	19081570	-	PVE11-6-W	19081571	-	1950x530x137	1956x536	6	2710

**SHOWCOOKING GLASS CERAMIC PLATE**

- Specially designed to hold, display and distribute hot food, presented on plates, after preparation in a show-cooking station, keeping displayed product at optimum temperatures during service time.
- 4 mm thickness, high-resistant, glass ceramic.



BLACK CERAMIC PLATE			WHITE CERAMIC PLATE			DIMENSIONS (mm)	CUT-OUT DIMENSIONS (mm)	Ø250mm PLATE CAPACITY	POWER (W)	
MODEL	CODE	€	MODEL	CODE	€					
	DDHC3-2	19107256	-	DDHC3-2-W	19107261	-	790x295x147	765x282	2	455
	DDHC3-3	19107258	-	DDHC3-3-W	19107262	-	1115x295x147	1090x282	3	680
	DDHC3-4	19107259	-	DDHC3-4-W	19107263	-	1440x295x147	1415x282	4	905
	DDHC3-5	19107260	-	DDHC3-5-W	19107264	-	1750x295x147	1740x282	5	1130

**PAELLA DISPLAY PLATE**

- Specially designed to hold, display and serve hot food presented on paella pans, keeping displayed product at optimum temperatures during service time.
- 4 mm thickness, high-resistant, glass ceramic.
- Includes a foodshield with light and heat using halogen lamps, to improve temperature maintenance and increase conservation time on the food surface.



PVEP- R-530

MODEL	CODE	DIMENSIONS (mm)	CUT-OUT DIMENSIONS (mm)	COLOUR	POWER (W)	€	
	PVEP-R-530	19106530	Ø 630x604	Ø 605	Black	935	-

**UNDERCOUNTER PLATE**

- Specially designed to be mounted under a countertop, keeping pre-heated products at optimum temperatures during service time.
- Heating system by hidden silicon heaters attached to the bottom of the plate.
- Working temperatures: +30°C/ +100°C.



PBCC-4

MODEL	CODE	DIMENSIONS (mm)	CAPACITY GN 1/1	POWER (W)	€	
	PBCC-2	19078507	611x590x147	2	905	-
	PBCC-3	19078508	936x590x147	3	1355	-
	PBCC-4	19078509	1261x590x147	4	1805	-
	PBCC-5	19078510	1586x590x147	5	2255	-
	PBCC-6	19078511	1911x590x147	6	2710	-

**BAIN MARIE WELL**

- Suitable for GN 1/1 pans or subdivisions with a maximum depth of 150 mm.

**Dry static bain marie well**

- Specially designed to hold, display and serve liquid or gravy warm food (e.g. soup, broth, stew, gravy, etc.) keeping displayed product at optimum temperatures during service time.
- Heating system by a set of heaters at the bottom of the tank.
- Working temperatures: +30°C/ +100°C.



DDHS6-4

MODEL	CODE	DIMENSIONS (mm)	CUT-OUT DIMENSIONS (mm)	CAPACITY GN 1/1	POWER (W)	€	
	DDHS6-3	19105718	1115x610x348	1090x585	3	1805	-
	DDHS6-4	19105719	1440x610x348	1415x585	4	2405	-
	DDHS6-5	19105720	1765x610x348	1740x585	5	3030	-

**Dry ventilated bain marie well**

- Specially designed to hold, display and serve warm food presented on deep GN pans (e.g. soup, stew, pasta, rice, sauces, meat, fish etc.) keeping displayed product at optimum temperatures during service time.
- Heating system by a set of heaters with fans that create a dynamic flow of hot air inside the well allowing a fast temperature setting up.
- Working temperatures: +30°C/ +100°C.



DDHV7-4

MODEL	CODE	DIMENSIONS (mm)	CUT-OUT DIMENSIONS (mm)	CAPACITY GN 1/1	POWER (W)	€	
	DDHV7-3	19105721	1115x720x348	1090x690	3	1250	-
	DDHV7-4	19105722	1440x720x348	1415x690	4	1250	-
	DDHV7-5	19105723	1765x720x348	1740x690	5	2050	-
	DDHV7-6	19105724	2090x720x348	2065x690	6	2050	-

**Wet bain marie well**

- Specially designed to hold, display and serve warm food presented on deep GN pans (e.g. soup, stew, pasta, rice, sauces, meat, fish etc.) keeping displayed product at optimum temperatures during service time.
- Heating system with hidden silicon heaters attached to the bottom of the well. Wet bain-marie system guarantees the best uniformity in heat distribution over the surface of the GN pans.

- Automatic filling: if water falls below a certain level, then sensor automatically activates electro-valve to fill the well.
- Manual filling: built-in water inlet with 1/2" ball electro-valve with flat tap to fill the well.
- CMMMA6-1: Manual water supply with buckets, without tap.
- Working temperatures: +30°C/ +90°C.



CBMAA6-4

AUTOMATIC FILLING				MANUAL FILLING				DIMENSIONS (mm)	CUT-OUT DIMENSIONS (mm)	CAPACITY GN 1/1	
MODEL	CODE	POWER (W)	€	MODEL	CODE	POWER (W)	€				
-	-	-	-	CBMAA6-1	19051982	1010	-	465x610x302	440x585	1	
	CBMAA6-1	19051980	1025	-	CBMA6-1	19043193	1010	-	515x610x302	490x585	1
	CBMAA6-2	19047656	1525	-	CBMA6-2	19043194	1510	-	790x610x302	765x585	2
	CBMAA6-3	19047657	2025	-	CBMA6-3	19043195	2005	-	1115x610x302	1090x585	3
	CBMAA6-4	19047658	2525	-	CBMA6-4	19043196	2510	-	1440x610x302	1415x585	4
	CBMAA6-5	19047659	3045	-	CBMA6-5	19043197	3030	-	1765x610x302	1740x585	5
	CBMAA6-6	19047660	3570	-	CBMA6-6	19047649	3555	-	2090x610x302	2065x585	6

**BAIN MARIE WELL FOR SAUCES**

- Specially designed to hold, display and serve warm sauces at show-cooking stations.
- Suitable for GN 1/6 pans with a maximum depth of 100 mm.

**Dry ventilated bain marie well**

- Heating system by a heater at the bottom of the tank.
- Working temperatures: +30°C/ +100°C.



CBMS16-4

MODEL	CODE	DIMENSIONS (mm)	CUT-OUT DIMENSIONS (mm)	CAPACITY GN 1/6	POWER (W)	€	
	CBMS16-3	19081509	576x256x252	551x227	3	860	-
	CBMS16-4	19081524	738x256x252	713x227	4	1210	-

**Wet bain marie well**

- Heating system with hidden silicon heaters attached to the bottom of the well.
- Wet bain-marie system guarantees the best uniformity in heat distribution over the surface of the GN pans.
- Automatic filling: if water falls below a certain level, then sensor automatically activates electro-valve to fill the well.
- Manual filling: built-in water inlet with 1/2" ball electro-valve with flat tap to fill the well.
- Working temperatures: +30°C/ +90°C.



CBMAA16-4

MODEL	CODE	DIMENSIONS (mm)	CUT-OUT DIMENSIONS (mm)	CAPACITY GN 1/6	WATER FILLING TYPE	POWER (W)	€
 CBMA16-3	19081533	584x256x252	551x227	3	Manual with tap	810	-
CBMA16-4	19081534	746x256x252	713x227	4	Manual with tap	810	-
CBMAA16-3	19081535	584x256x292	551x227	3	Automatic	820	-
CBMAA16-4	19081536	746x256x292	713x227	4	Automatic	820	-

**CARVING STATION**



- Specially designed to hold, display, carve and serve warm food (e.g. roast beef, ham, turkey breast, etc.) in show-cooking stations, keeping displayed product at optimum temperatures during service time.
- Heat sources in the lower (base with water bain marie) and upper part (lamp with ceramic Heat) of the carving station.
- Stainless steel, easy to clean, perforated base to place the product.
- Automatic filling: if water falls below a certain level, then sensor automatically activates electro-valve to fill the well.
- Manual filling: built-in water inlet with 1/2" ball electro-valve with flat tap to fill the well.
- Working temperatures: +30°C/ +90°C.



TRCBMA6-1



TRCBMA6-2

AUTOMATIC FILLING				MANUAL FILLING				DIMENSIONS (mm)	CUT-OUT DIMENSIONS (mm)	CAPACITY GN 1/1
MODEL	CODE	POWER (W)	€	MODEL	CODE	POWER (W)	€			
 TRCBMAA6-1	19079250	1300	-	TRCBMA6-1	19079228	1285	-	515x610x1005	490x585	1
 TRCBMAA6-2	19079251	2575	-	TRCBMA6-2	19079229	2560	-	790x610x1005	765x585	2

**SOUP WELL**

- Specially designed to hold, display and serve liquid or gravy warm food (e.g. soup, broth, stew, gravy, etc.) keeping product at optimum temperatures during service time.
- Dry bain-marie heating system by circular heater surrounding the well. No drain required.
- Adjustment of heating power by an energy regulator.



OS1-10

MODEL	CODE	DIMENSIONS (mm)	CUT-OUT DIMENSIONS (mm)	CAPACITY (L)	POWER (W)	€
 OS1-10	19083985	Ø 295X315	Ø 276	10L	475	-

# Cold-hot mixed elements

**General characteristics**





- Specially designed to hold, display and distribute chilled or hot food on the same surface.
- Manufactured in stainless steel with satin finish.
- Heating system by hidden silicon heaters attached to the bottom of the plate.
- Static refrigeration system by expanded copper coil located in its base.
- Wool rock insulation allowing energy savings by reducing heat loss.
- Control panel with digital thermostat, protected by the structure perimeter, avoiding hindrances in their daily use.
- Minimum programmed time delay for switching from cold to heat or vice versa, for a correct use of the equipment.
- Mixed glass ceramic plate: 4 mm thickness, high-resistant, white colour glass ceramic envelope completely flat.
- Mixed stainless steel plate: top plate surface manufactured in stainless steel, completely flat.
- Working temperatures:
  - In heat mode: +30°C/ +100°C.
  - In cold mode: -8 °C/ +5 °C (In climate class conditions 4).
- 220-240V 1N~ 50/60Hz.



FPRV6-3-W



FPRSS6-3

MODEL	CODE	GAS	DIMENSIONS (mm)	CUT-OUT DIMENSIONS (mm)	CAPACITY GN 1/1	POWER (W)	COLD GROUP	€
MIXED WHITE GLASS CERAMIC PLATE								
 FPRV6-2-W	19092274	R-290	790x610x478	765x585	2	990	Included	-
 FPRV6-3-W	19092275	R-290	1115x610x478	1090x585	3	1490	Included	-
MIXED STAINLESS STEEL PLATE								
 FPRSS6-2	19092278	R-290	790x610x478	765x585	2	990	Included	-
 FPRSS6-3	19092279	R-290	1115x610x478	1090x585	3	1490	Included	-

Check remote versions at the end of the chapter.

# Foodshields

## General characteristics

- Specially designed to improve food hygiene during service thanks to its anti-breath function.
- Manufactured in stainless steel with a solid and robust structure, in round tube of Ø 51 mm or rectangular 60 x 30 mm.
- Clamps to easily fasten ICC glasses, both curved or straight, one-sided or two-sided.
- Brackets are easily mounted on the structure by means of threaded plates.



### Foodshields with light, halogen heat and ceramic heat

- 35 mm distance between the bracket and the foodshield to make cleaning operations easier.
- Foodshields with light: high-luminosity LED lighting. To be installed over neutral or refrigerated technical elements.
- Foodshields with halogen heat: lighting and heat by protected halogen lamps, integrated side to side.
- Foodshields with ceramic heat: light and heat generated by protected halogen lamps and alternating ceramic elements. Ceramic elements provide a more intense and concentrated heat.

GN 1/1 CAPACITY	HEIGHT (mm)	CUT-OUT DIMENSIONS (mm)	POWER (W)	GLASS SHAPE			BRACKET				
				VOLTAGE AND HZ	MODEL	CÓDIGO	€	MODEL	CODE	€	
<b>NEUTRAL FOODSHIELDS</b>											
1 Level	426				DDFN	19106278	-	ISPCCS-R	19071964	DDFNT-R	19105717
2 Levels	676							ISPCCS-R-2	19071966		
<b>FOODSHIELDS WITH LIGHT</b>											
2	426	720	15	100-240V 1N~ 50/60Hz	DDFL-2	19105702	-	DDFL-R-2	19105707	DDFLT-R-2	19105712
3	426	1045	25		DDFL-3	19105703	-	DDFL-R-3	19105708	DDFLT-R-3	19105713
4	426	1370	35		DDFL-4	19105704	-	DDFL-R-4	19105709	DDFLT-R-4	19105714
5	426	1695	45		DDFL-5	19105705	-	DDFL-R-5	19105710	DDFLT-R-5	19105715
6	426	2020	55		DDFL-6	19105706	-	DDFL-R-6	19105711	DDFLT-R-6	19105716
<b>FOODSHIELDS WITH HALOGEN HEAT</b>											
2	426	720	600	220-240V 1N~ 50/60Hz	DDFH-2	19105672	-	DDFH-R-2	19105677	DDFHT-R-2	19105682
3	426	1045	900		DDFH-3	19105673	-	DDFH-R-3	19105678	DDFHT-R-3	19105683
4	426	1370	1200		DDFH-4	19105674	-	DDFH-R-4	19105679	DDFHT-R-4	19105684
5	426	1695	1500		DDFH-5	19105675	-	DDFH-R-5	19105680	DDFHT-R-5	19105685
6	426	2020	1500		DDFH-6	19105676	-	DDFH-R-6	19105681	DDFHT-R-6	19105686
<b>FOODSHIELDS WITH CERAMIC HEAT</b>											
2	426	720	650	220-240V 1N~ 50/60Hz	DDFC-2	19105687	-	DDFC-R-2	19105692	DDFCT-R-2	19105697
3	426	1050	1050		DDFC-3	19105688	-	DDFC-R-3	19105693	DDFCT-R-3	19105698
4	426	1370	1450		DDFC-4	19105689	-	DDFC-R-4	19105694	DDFCT-R-4	19105699
5	426	1695	1850		DDFC-5	19105690	-	DDFC-R-5	19105695	DDFCT-R-5	19105700
6	426	2020	1850		DDFC-6	19105691	-	DDFC-R-6	19105696	DDFCT-R-6	19105701

### Neutral brackets for frontal protection glasses

- Specially designed as a protective element in show-cookings or self-service configurations.
- IDFG frontal protection glass is not included and has to be ordered separately.

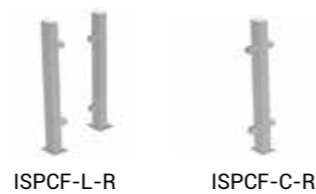

MODEL	BRACKET	CODE	DIMENSIONS (mm)	DESCRIPTION	€
ISPCF-L-R		19043361	69x72x423	Set of two (2) side brackets.	-
ISPCF-C-R		19043362	98x70x423	One (1) central bracket.	-

# Glasses

## General characteristics

- Tempered glasses.
- Protects food on display against breaths and guests against vapors.
- Fixed by using a clamp included in the foodshield bracket.

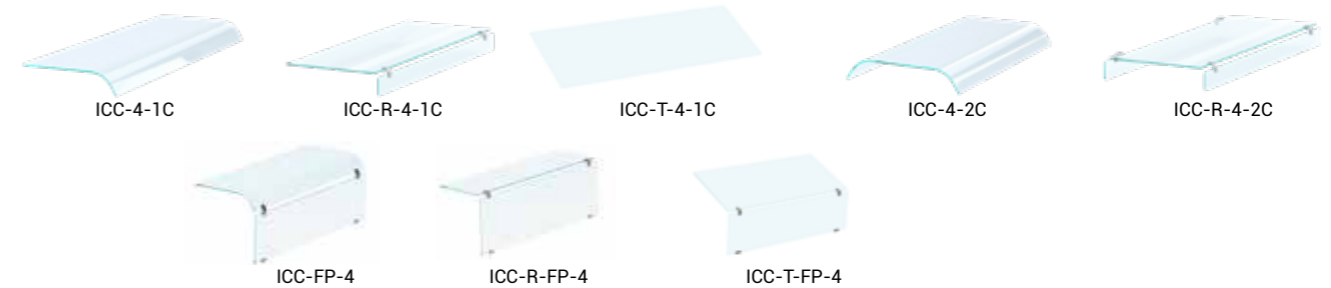

CAPACITY GN 1/1	MODEL	CODE	DIMENSIONS (mm)	€	MODEL	CODE	DIMENSIONS (mm)	€	MODEL	CODE	DIMENSIONS (mm)	€
<b>FRONTAL GLASS</b>												
2	ICC-2-1C	19043272	675x500x108	-	ICC-R-2-1C	19043293	675x433x123	-	ICC-T-2-1C	19087365	675x520x6	-
3	ICC-3-1C	19043273	1000x500x108	-	ICC-R-3-1C	19043295	1000x433x123	-	ICC-T-3-1C	19087366	1000x520x6	-
4	ICC-4-1C	19043274	1325x500x108	-	ICC-R-4-1C	19043296	1325x433x123	-	ICC-T-4-1C	19087367	1325x520x6	-
5	ICC-5-1C	19043275	1650x500x108	-	ICC-R-5-1C	19043297	1650x433x123	-	ICC-T-5-1C	19087368	1650x520x6	-
6	ICC-6-1C	19047838	1975x500x108	-	ICC-R-6-1C	19047843	1975x433x123	-	ICC-T-6-1C	19087363	1975x520x6	-
<b>CENTRAL GLASS</b>												
2	ICC-2-2C	19046893	675x570x108	-	ICC-R-2-2C	19043298	675x585x123	-	-	-	-	-
3	ICC-3-2C	19046894	1000x570x108	-	ICC-R-3-2C	19043301	1000x585x123	-	-	-	-	-
4	ICC-4-2C	19046895	1325x570x108	-	ICC-R-4-2C	19043302	1325x585x123	-	-	-	-	-
5	ICC-5-2C	19046896	1650x570x108	-	ICC-R-5-2C	19043303	1650x585x123	-	-	-	-	-
6	ICC-6-2C	19047839	1975x570x108	-	ICC-R-6-2C	19047844	1975x585x123	-	-	-	-	-
<b>CLOSED FRONTAL GLASS</b>												
2	ICCS-FP-2	19072070	675x515x420	-	ICCS-R-FP-2	19072075	675x433x420	-	ICCS-T-FP-2	19105647	675x486x525	-
3	ICCS-FP-3	19072071	1000x515x420	-	ICCS-R-FP-3	19072076	1000x433x420	-	ICCS-T-FP-3	19105648	1000x486x525	-
4	ICCS-FP-4	19072072	1325x515x420	-	ICCS-R-FP-4	19072077	1325x433x420	-	ICCS-T-FP-4	19105649	1325x486x525	-
5	ICCS-FP-5	19072073	1650x515x420	-	ICCS-R-FP-5	19072078	1650x433x420	-	ICCS-T-FP-5	19105670	1650x486x525	-
6	ICCS-FP-6	19072074	1975x515x420	-	ICCS-R-FP-6	19072079	1975x433x420	-	ICCS-T-FP-6	19105671	1975x486x525	-

### Frontal protection glasses for neutral brackets

- Glass specially designed to protect the guest from an unwanted contact.
- Tempered glass to be used in combination with neutral brackets.



MODEL	CODE	DIMENSIONS (mm)	CAPACITY GN 1/1	€
IDFG-2	19043312	675x395x6	2	-
IDFG-3	19043314	1000x395x6	3	-
IDFG-4	19043315	1325x395x6	4	-
IDFG-5	19043316	1650x395x6	5	-
IDFG-6	19047848	1975x395x6	6	-



# Cubic refrigerated vitrines

## General characteristics

- Specially designed to hold, display and serve chilled food (e.g. fruits, desserts, yogurts, cold appetizers, presented on plates/ramekins, etc.) and beverages (bottles, cans) keeping displayed product at optimum temperatures during extended service times, up to 24-hour operations.
- Manufactured in stainless steel with satin finish.
- Polyurethane insulation with ecological injection, allowing energy savings by reducing loss of cold air.

- Electronic thermostat, with digital display, to control and regulate the temperature on the ventilated well at the desired set point and turn on the lighting of the display.
- Automatic defrost system that minimizes compressor workload and saves energy.
- LED light strip integrated on the display top.
- 220-240V 1N~.

## CUBIC REFRIGERATED VITRINES WITH VENTILATED WELL

- Ventilated refrigerated well with height-adjustable base to display pans with different heights. Flat display level and drainage area slightly bent.
- Ventilated refrigeration system with high-performance electronic fans and large area evaporators.
- Robust structure with 13 mm thick overlap, once element is dropped-in on the worktop, ensuring cleanness and aesthetics.
- Evaporation tray, with intelligent evaporation system of defrost water, as accessories.
- Easily removable and height adjustable tempered glass shelves.
- Textile curtain: previously refrigerated food is kept chilled for a limited duration of 3-4 hours when the display is open on the customer side.

- Front clapets: in plastic to access the food on each shelf.
- Closed: tempered front glass window, firmly fixed by using anodized aluminum clamps which allows the glass to be folded for cleaning.
- Control panel with digital thermostat, protected by the structure perimeter, avoiding hindrances in their daily use.
- Climate class: 3M2 in models with textile curtain (CT) and 3M1 in models with Clapets (CP) and closed (CL).
- Working temperatures: +4°C/ +10°C.



DDRVC7-H-CT-3-4



DDRVC7-S-CL-3-4



DDRVC7-W-CP-3-4



DDRVC7-S-CL-2-4

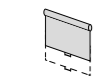

### Client side: TEXTILE CURTAIN (CT)

MODEL	CODE	GAS	HZ	DIMENSIONS (mm)	CUT-OUT DIMENSIONS (mm)	CAPACITY GN 1/1	POWER (W)	COLD GROUP	€
3 LEVELS SERVICE SIDE: SWING DOORS (H)									
DDRVC7-H-CT-3-2	19106279	R290	50	790x720x1488	765x690	2	665	Included	-
DDRVC7-H-CT-3-3	19106280	R290	50	1115x720x1488	1090x690	3	970	Included	-
DDRVC7-H-CT-3-4	19106281	R290	50	1440x720x1488	1415x690	4	1200	Included	-
SERVICE SIDE: SLIDING DOORS (S)									
DDRVC7-S-CT-3-3	19106288	R290	50	1115x720x1476	1090x690	3	665	Included	-
DDRVC7-S-CT-3-4	19106289	R290	50	1440x720x1476	1415x690	4	1200	Included	-
SERVICE SIDE: WALL TYPE (W)									
DDRVC7-W-CT-3-2	19106296	R290	50	790x720x1488	765x690	2	545	Included	-
DDRVC7-W-CT-3-3	19106297	R290	50	1115x720x1488	1090x690	3	810	Included	-
DDRVC7-W-CT-3-4	19106298	R290	50	1440x720x1488	1415x690	4	1000	Included	-

Check remote versions at the end of the chapter.



### Client side: CLAPETS (CP)

MODEL	CODE	GAS	HZ	DIMENSIONS (mm)	CUT-OUT DIMENSIONS (mm)	CAPACITY GN 1/1	POWER (W)	COLD GROUP	€
3 LEVELS SERVICE SIDE: SWING DOORS (H)									
DDRVC7-H-CP-3-2	19106282	R290	50	790x720x1488	765x690	2	665	Included	-
DDRVC7-H-CP-3-3	19106283	R290	50	1115x720x1488	1090x690	3	970	Included	-
DDRVC7-H-CP-3-4	19106284	R290	50	1440x720x1488	1415x690	4	1200	Included	-
SERVICE SIDE: SLIDING DOORS (S)									
DDRVC7-S-CP-3-3	19106290	R290	50	1115x720x1476	1090x690	3	665	Included	-
DDRVC7-S-CP-3-4	19106291	R290	50	1440x720x1476	1415x690	4	1200	Included	-
DDRVC7-S-CP-3-5	19106292	R290	50	1765x720x1476	1740x690	5	1250	Included	-
SERVICE SIDE: WALL TYPE (W)									
DDRVC7-W-CP-3-2	19106299	R290	50	790x720x1488	765x690	2	545	Included	-
DDRVC7-W-CP-3-3	19106300	R290	50	1115x720x1488	1090x690	3	810	Included	-
DDRVC7-W-CP-3-4	19106301	R290	50	1440x720x1488	1415x690	4	1000	Included	-



### Client side: CLOSED (CL)

MODEL	CODE	GAS	HZ	DIMENSIONS (mm)	CUT-OUT DIMENSIONS (mm)	CAPACITY GN 1/1	POWER (W)	COLD GROUP	€
3 LEVELS SERVICE SIDE: SWING DOORS (H)									
DDRVC7-H-CL-3-2	19106285	R290	50	790x720x1488	765x690	2	410	Included	-
DDRVC7-H-CL-3-3	19106286	R290	50	1115x720x1488	1090x690	3	470	Included	-
DDRVC7-H-CL-3-4	19106287	R290	50	1440x720x1488	1415x690	4	650	Included	-
SERVICE SIDE: SLIDING DOORS (S)									
DDRVC7-S-CL-3-3	19106293	R290	50	1115x720x1476	1090x690	3	470	Included	-
DDRVC7-S-CL-3-4	19106294	R290	50	1440x720x1476	1415x690	4	650	Included	-
DDRVC7-S-CL-3-5	19106295	R290	50	1765x720x1476	1740x690	5	725	Included	-
2 LEVELS SERVICE SIDE: SLIDING DOORS (S)									
DDRVC7-S-CL-2-3	19106302	R290	50	1115x720x1276	1090x690	3	390	Included	-
DDRVC7-S-CL-2-4	19106303	R290	50	1440x720x1276	1415x690	4	550	Included	-
DDRVC7-S-CL-2-5	19106304	R290	50	1765x720x1276	1740x690	5	675	Included	-

## INDEPENDENT CUBIC REFRIGERATED VITRINES

- Ventilated refrigeration system with high-performance electronic fans and large area evaporators.
- Evaporation tray, with intelligent evaporation system of defrost water, as standard accessory.
- Sliding doors on the service side of the display, to make easier product loading/replacement operations.
- Plastic front clapets to access the food on each shelf.
- Stainless steel shelves, without possibility of height adjustment.

- DDRVCO models: open base, which can be installed on any static refrigerated plate/well by means of supplied fittings.
- DDRVCC models: isolated flat base, to be installed as an independent element on any flat surface.
- Climate class: 3M1.
- Working temperatures: +2°C/ +10°C.



DDRVCO6-S-CP-4



DDRVCC6-S-CP-4

OPEN BASE			ISOLATED FLAT BASE			GAS	HZ	DIMENSIONS (mm)	CAPACITY GN 1/1	POWER (W)	COLD GROUP
MODEL	CODE	€	MODEL	CODE	€						
DDRVCO6-S-CP-3	19106305	-	DDRVCC6-S-CP-3	19106308	-	R290	50	1106x600x1188	3	910	Included
DDRVCO6-S-CP-4	19106306	-	DDRVCC6-S-CP-4	19106309	-	R290	50	1431x600x1188	4	1045	Included
DDRVCO6-S-CP-5	19106307	-	DDRVCC6-S-CP-5	19106413	-	R290	50	1756x600x1188	5	1280	Included

Check remote versions at the end of the chapter.

# Cubic hot vitrines

## General characteristics

- Specially designed to hold, display and serve hot food presented on plates or shallow GN 1/1 pans (e.g. hot appetizers, sandwiches, pies, pizza, etc.) keeping displayed product at optimum temperatures during service time.
- Structure manufactured in stainless steel with satin finish.
- 4mm thickness, very durable glass ceramic shelf and plate.
- Heating system by hidden silicon heaters attached to the bottom of the glass ceramic plate and shelf.
- Foodshields with light and heat by protected halogen lamps located over the glass ceramic plate and shelf (except with customer side closed).
- Two (2) or three (3) electronic thermostats, with digital display, to control and regulate the temperature on the glass ceramic plate and on the shelf(ves) separately, at the desired set point.
- Sliding doors on the service side of the display, to make easier product loading/replacement operations.
- Closed service side: tempered front glass window, firmly fixed by using anodized aluminum clamps which allows the glass to be folded for cleaning.
- Robust structure with 13 mm thick overlap, once element is dropped-in on the worktop, ensuring cleanness and aesthetics.
- Working temperatures: +30°C/ +100°C in models with customer side opened and +30°C/+80°C in models with customer side closed.



DDHVC7-S-3-4



DDHVC7-W-3-4



DDHVC7-S-CL-2-4

	MODEL	VOLTAGE AND FREQUENCY (Hz)	CODE	DIMENSIONS (mm)	CUT-OUT DIMENSIONS (mm)	CAPACITY GN 1/1	CLIENT SIDE	POWER (W)	€
3 LEVELS	SERVICE SIDE: SLIDING DOORS (S)								
	DDHVC7-S-3-3	220-240V 1N~ 50/60Hz	19106311	1115x720x952	1090x690	3	Open	3620	-
	DDHVC7-S-3-4	380-415V 3N~ 50/60Hz	19106312	1440x720x952	1415x690	4	Open	4970	-
	DDHVC7-S-3-5	380-415V 3N~ 50/60Hz	19106313	1765x720x952	1740x690	5	Open	6320	-
3 LEVELS	SERVICE SIDE: WALL TYPE (W)								
	DDHVC7-W-3-3	220-240V 1N~ 50/60Hz	19106314	1115x720x952	1090x690	3	Open	3620	-
	DDHVC7-W-3-4	380-415V 3N~ 50/60Hz	19106315	1440x720x952	1415x690	4	Open	4970	-
	DDHVC7-W-3-5	380-415V 3N~ 50/60Hz	19106316	1765x720x952	1740x690	5	Open	6320	-
2 LEVELS	SERVICE SIDE: SLIDING DOORS (S)								
	DDHVC7-S-CL-2-3	220-240V 1N~ 50/60Hz	19106317	1115x720x742	1090x690	3	Closed	1965	-
	DDHVC7-S-CL-2-4	220-240V 1N~ 50/60Hz	19106318	1440x720x742	1415x690	4	Closed	2710	-
	DDHVC7-S-CL-2-5	220-240V 1N~ 50/60Hz	19106319	1765x720x742	1740x690	5	Closed	3465	-

# Reserves

## General characteristics

- Specifically designed to be installed under a worktop in order to hold chilled or hot products.
- Manufactured in stainless steel with a solid and robust structure.
- Cold reserves:
  - With hinged doors or drawers, to house containers or grills GN 2/1 or GN 1/1.
  - Forced draft evaporator and removable pull-out/push-in magnetic door gasket, to keep maximum hygiene.
- Automatic evaporation system of defrost water as an accessory.
- Working temperatures: +0°C/ +6°C.
- Hot reserves:
  - Double-wall sliding doors and forced air heating system.
  - Working temperatures: +30°C/ +90°C.
- Electronic thermostat, with digital display, to control and regulate the temperature at the desired set point.



DDRC4-21 DD



DDRC5-22 HH



TMH4-714 SE

MODEL	GAS	CODE	DIMENSIONS (mm)	CAPACITY GN	Nº OF DOORS	Nº OF DRAWERS	POWER (W)	CLIMATE CLASS	COLD GROUP	€
COLD RESERVE										
DDRC4-12 D	R290	19105783	1370x676x450	GN 2/1	1	-	150	4	Included	-
DDRC4-22 DD	R290	19105784	1763x766x450	GN 2/1	2	-	210	4	Included	-
DDRC5-12 D	R290	19105785	1145x766x586	GN 2/1	1	-	165	4	Included	-
DDRC5-22 DD	R290	19105786	1763x766x586	GN 2/1	2	-	270	4	Included	-
DDRC5-12 H	R290	19105787	1145x766x586	GN 2/1	-	2	165	4	Included	-
DDRC5-22 HH	R290	19105788	1763x766x586	GN 2/1	-	4	270	4	Included	-
DDRC4-21 DD	R290	19105795	1370x676x450	GN 1/1	2	-	155	4	Included	-
DDRC4-31 DDD	R290	19105796	1763x676x450	GN 1/1	3	-	160	4	Included	-
DDRC5-21 DD	R290	19105797	1370x676x586	GN 1/1	2	-	165	4	Included	-
DDRC5-31 DDD	R290	19105798	1763x676x586	GN 1/1	3	-	275	4	Included	-
DDRC5-21 HH	R290	19105799	1370x676x586	GN 1/1	-	4	165	4	Included	-
DDRC5-31 HHH	R290	19105800	1763x676x586	GN 1/1	-	6	275	4	Included	-

Check remote versions at the end of the chapter.

MODEL	CODE	DIMENSIONS (mm)	POWER (W)	€
HOT RESERVE				
TMH4-712 SE	19105725	1196x685x450	1450	-
TMH4-714 SE	19105726	1395x685x450	1450	-
TMH4-716 SE	19105727	1596x685x450	1450	-
TMH4-718 SE	19105728	1796x685x450	2470	-
TMH4-720 SE	19105729	1996x685x450	2470	-
TMH6-712 SE	19105730	1196x685x610	1450	-
TMH6-714 SE	19105731	1396x685x610	1450	-
TMH6-716 SE	19105732	1596x685x610	2470	-
TMH6-718 SE	19105733	1796x685x610	2470	-
TMH6-720 SE	19105734	1996x685x610	2870	-
COMMON ACCESORIES				
KPSR	19056083	Set of 4 legs (height 150 mm)		-

# Dispensers

## General characteristics

- Specially designed to store and serve neutral and hot plates and ware-washing baskets.
- Made of stainless steel.
- Special system with steel springs, keeping the plates at a constant level for easy service.
- Easy to place and remove.



MODEL	HZ	CODE	DIMENSIONS (mm)	CUT-OUT DIAMETER (mm)	Ø PLATES (mm)	PLATE CAPACITY	MAXIMUM LOAD (KG)	POWER (W)	€
<b>NEUTRAL PLATE DISPENSER</b>									
IDPN-28	-	19046408	391x730	Ø375	de 180 a 280	40/45	45	-	-
IDPN-34	-	19043371	451x730	Ø434	de 240 a 340	40/45	45	-	-
<b>HOT PLATE DISPENSER</b>									
IDPC-28	50/60	19043372	420x730	Ø407	de 180 a 280	40/45	45	480	-
IDPC-34	50/60	19043373	480x730	Ø466	de 240 a 340	40/45	45	480	-

MODEL	CODE	DIMENSIONS (mm)	DISPENSER	Ø PLATES (mm)	€
<b>COVER FOR PLATE DISPENSER</b>					
ITDP-28	19043374	Ø400x60	IDPC-28 - IDPN-28	de 180 a 280	-
ITDP-34	19043375	Ø400x60	IDPC-34 - IDPN-34	de 240 a 340	-

MODEL	CODE	DIMENSIONS (mm)	CUT-OUT DIMENSIONS (mm)	BASKETS (mm)	BASKET CAPACITY (110MM HEIGHT)	MAXIMUM LOAD (KG)	€
<b>BASKET DISPENSER</b>							
IDCN-55	19043376	600x640x710	535x610	500 x 500	5/6	120	-

# Accessories



MODEL	HZ	CODE	DIMENSIONS (mm)	DESCRIPTION	POWER (W)	€
<b>EVAPORATION KIT DEFROST WATER</b>						
DDAES	50/60	19105737	274x74x74	Static refrigeration and cold reserves	100	-
EV-KIT-450	50/60	19046595	400x170x65	Ventilated wells, closed (CL) vitrines and 2-3 GN 1/1 vitrines with textile curtains (CT) or clapets (CP)	450	-
EV-KIT-900	50/60	19046596	400x170x65	4-5 GN 1/1 vitrines with textile curtains (CT) or clapets (CP)	900	-
<b>OVERFLOW PAN DEFROST WATER</b>						
OF-PAN		19046598	GN 1/1 (65 mm de alto)	All refrigerated drop-in elements		-
<b>TOOL TO LIFT DROP-IN</b>						
PAL-DROPIN		19046641	-	All refrigerated drop-in elements		-
<b>DIGITAL THERMOMETER KIT</b>						
IPCTI/C	50/60	19053060	132x84x70	Switch	1	-
DDATC	50/60	19105738	132x84x70	Cold thermometer	1	-
DDATCS	50/60	19105739	132x84x70	Cold thermometer + switch	1	-
DDATH	50/60	19105740	132x84x70	Hot thermometer	1	-
DDATHS	50/60	19105741	132x84x70	Hot thermometer + switch	1	-

# Remote codes

## Static plates and wells

MODEL	CODE	HZ	CAPACITY GN 1/1	€
<b>1 LEVEL PLATE</b>				
DDCSP6-2-R	19105752	50/60	2	-
DDCSP6-3-R	19105753	50/60	3	-
DDCSP6-4-R	19105754	50/60	4	-
DDCSP6-5-R	19105755	50/60	5	-
DDCSP6-6-R	19105756	50/60	6	-
<b>2 LEVELS PLATE</b>				
DDCS2P6-3-R	19105971	50/60	3	-
DDCS2P6-4-R	19105761	50/60	4	-
DDCS2P6-5-R	19105762	50/60	5	-
<b>STATIC 80 mm WELL</b>				
DDCSB6-80-3-R	19105766	50/60	3	-
DDCSB6-80-4-R	19105767	50/60	4	-
DDCSB6-80-5-R	19105768	50/60	5	-
<b>STATIC 160 mm WELL</b>				
DDCSB6-160-2-R	19105774	50/60	2	-
DDCSB6-160-3-R	19105775	50/60	3	-
DDCSB6-160-4-R	19105776	50/60	4	-
DDCSB6-160-5-R	19105777	50/60	5	-
DDCSB6-160-6-R	19105778	50/60	6	-
<b>FRESH PRODUCT SHOWCASE WELL</b>				
DDCE6-80-1-R	19105781	50/60	1	-
DDCE6-80-2-R	19105782	50/60	2	-

## Undercounter plate

MODEL	CODE	HZ	CAPACITY GN 1/1	€
FPBCF-2-R	19092133	50/60	2	-
FPBCF-3-R	19092134	50/60	3	-
FPBCF-4-R	19092135	50/60	4	-
FPBCF-5-R	19092136	50/60	5	-
FPBCF-6-R	19092137	50/60	6	-

## Ventilated well

MODEL	CODE	HZ	CAPACITY GN 1/1	€
FCRV7-2-R	19091739	50/60	2	-
FCRV7-3-R	19091740	50/60	3	-
FCRV7-4-R	19091741	50/60	4	-
FCRV7-5-R	19091742	50/60	5	-
FCRV7-6-R	19091743	50/60	6	-

## Well for frozen products

MODEL	CODE	HZ	CAPACITY	€
DDCF6-4-R	19106274	50/60	4	-

## Cold-hot mixed elements

MODEL	CODE	HZ	CAPACITY GN 1/1	€
<b>MIXED WHITE GLASS CERAMIC PLATE</b>				
FPRV6-2-W-R	19092276	50/60	2	-
FPRV6-3-W-R	19092277	50/60	3	-
<b>MIXED STAINLESS STEEL PLATE</b>				
FPRSS6-2-R	19092280	50/60	2	-
FPRSS6-3-R	19092281	50/60	3	-

## Cubic refrigerated vitrines with ventilated well

### Client side: TEXTILE CURTAIN (CT)

MODEL	CODE	HZ	CAPACITY GN 1/1	€
<b>SERVICE SIDE: SWING DOORS (H)</b>				
DDRVC7-H-CT-3-2-R	19107534	50/60	2	-
DDRVC7-H-CT-3-3-R	19107535	50/60	3	-
DDRVC7-H-CT-3-4-R	19107536	50/60	4	-
<b>SERVICE SIDE: SLIDING DOORS (S)</b>				
DDRVC7-S-CT-3-3-R	19107537	50/60	3	-
DDRVC7-S-CT-3-4-R	19107538	50/60	4	-
<b>SERVICE SIDE: WALL TYPE (W)</b>				
DDRVC7-W-CT-3-2-R	19107539	50/60	2	-
DDRVC7-W-CT-3-3-R	19107541	50/60	3	-
DDRVC7-W-CT-3-4-R	19107542	50/60	4	-

### Client side: CLAPETS (CP)

MODEL	CODE	HZ	CAPACITY GN 1/1	€
<b>SERVICE SIDE: SWING DOORS (H)</b>				
DDRVC7-H-CP-3-2-R	19107543	50/60	2	-
DDRVC7-H-CP-3-3-R	19107544	50/60	3	-
DDRVC7-H-CP-3-4-R	19107545	50/60	4	-
<b>SERVICE SIDE: SLIDING DOORS (S)</b>				
DDRVC7-S-CP-3-3-R	19107546	50/60	3	-
DDRVC7-S-CP-3-4-R	19107547	50/60	4	-
DDRVC7-S-CP-3-5-R	19107548	50/60	5	-
<b>SERVICE SIDE: WALL TYPE (W)</b>				
DDRVC7-W-CP-3-2-R	19107549	50/60	2	-
DDRVC7-W-CP-3-3-R	19107550	50/60	3	-
DDRVC7-W-CP-3-4-R	19107551	50/60	4	-

### CLIENT SIDE: CLOSED (CL)

MODEL	CODE	HZ	CAPACITY GN 1/1	€
<b>SERVICE SIDE: SWING DOORS (H)</b>				
DDRVC7-H-CL-3-2-R	19107552	50/60	2	-
DDRVC7-H-CL-3-3-R	19107553	50/60	3	-
DDRVC7-H-CL-3-4-R	19107554	50/60	4	-
<b>SERVICE SIDE: SLIDING DOORS (S)</b>				
DDRVC7-S-CL-3-3-R	19107555	50/60	3	-
DDRVC7-S-CL-3-4-R	19107556	50/60	4	-
DDRVC7-S-CL-3-5-R	19107557	50/60	5	-
<b>SERVICE SIDE: SLIDING DOORS (S)</b>				
DDRVC7-S-CL-2-3-R	19107558	50/60	3	-
DDRVC7-S-CL-2-4-R	19107559	50/60	4	-
DDRVC7-S-CL-2-5-R	19107560	50/60	5	-

## Cold reserve

MODEL	CODE	HZ	CAPACITY GN	Nº OF DOORS	Nº OF DRAWERS	€
DDRC4-12 D-R	19105789	50/60	GN 2/1	1		-
DDRC4-22 DD-R	19105790	50/60	GN 2/1	2		-
DDRC5-12 D-R	19105791	50/60	GN 2/1	1		-
DDRC5-22 DD-R	19105792	50/60	GN 2/1	2		-
DDRC5-12 H-R	19105793	50/60	GN 2/1		2	-
DDRC5-22 HH-R	19105794	50/60	GN 2/1		4	-
DDRC4-21 DD-R	19105801	50/60	GN 1/1	2		-
DDRC4-31 DDD-R	19105802	50/60	GN 1/1	3		-
DDRC5-21 DD-R	19105803	50/60	GN 1/1	2		-
DDRC5-31 DDD-R	19105804	50/60	GN 1/1	3		-
DDRC5-21 HH-R	19105805	50/60	GN 1/1		4	-
DDRC5-31 HHH-R	19105806	50/60	GN 1/1		6	-





# Self Service

Self Suite .....	397
— Dispensers.....	399
— Neutral elements.....	401
— Refrigerated elements.....	403
— Hot elements .....	405
— 3-level cubic refrigerated ventilated ...	407
— Cubic hot vitrines .....	408
Foodshield with shelf and protection frontal glass .....	409
Foodshields and Glasses .....	409
Accessories .....	410
Configuration options .....	412



Flexibility to adapt to all spaces  
with ergonomics.



Access the website

















# Dispensers

## General characteristics

- Dispensers specially designed to store and distribute serving trays, cutlery pieces, bread rolls and / or glasses.
- Manufactured with a sturdy, high-quality, stainless steel structure.
- Dispensers over a base.
- 400 mm height, 1.5 mm thickness stainless steel worktop in satin finish.
- Front panels in water-resistant medium density fibreboard (MDF).
- Facade decoration with laminated panels to be chosen from 16 basic colors. Four (4) decorated sides.
- Decoration facade at 150 mm from the ground.



MODEL	CODE	DIMENSIONS (mm)	DESCRIPTION	TRAY CAPACITY	CUTLERY CAPACITY	BREAD ROLL CAPACITY	GLASS CAPACITY (Ø80 mm // Ø75mm)	BRACKET	€
<b>TRAY DISPENSER</b>									
	SS-77	18001483	798x780x400	2 Columns	160	-	-	-	-
	SS-147	18001484	1450x780x400	4 Columns	320	-	-	-	-
<b>TRAY AND CUTLERY DISPENSER OVER A BASE</b>									
	D-R-313	18003180	798x780x1514	3 GN 1/3 - 150mm	160	150	-	Rectangular	-
	D-R-613	18003190	1450x780x1514	6 GN 1/3 - 150mm	320	300	-	Rectangular	-
<b>TRAY, CUTLERY AND BREAD DISPENSER OVER A BASE</b>									
	D-R-313/2	18003191	798x780x1514	3 GN 1/3 - 150mm + 1 GN 2/1 - 200mm	160	150	120	Rectangular	-
	D-R-613/2	18003192	1450x780x1514	6 GN 1/3 - 150mm + 2 GN 2/1 - 200mm	320	300	240	Rectangular	-
<b>GLASS DISPENSER OVER A BASE</b>									
	DV-R-6	18003193	798x780x1569	6 glass levels	-	-	-	324/360	Rectangular
	DV-R-62	18003196	1450x780x1569	2x6 glass levels	-	-	-	648/720	Rectangular
<b>TRAY, CUTLERY, BREAD AND GLASS DISPENSER OVER A BASE</b>									
	DVCP-R-6	18003199	1450x780x1569	3 GN 1/3 - 150 mm + 1 GN 2/1 - 200 mm + 6 glass levels	160	150	120	324/360	Rectangular

MODEL	CODE	DIMENSIONS (mm)	DESCRIPTION	CUTLERY CAPACITY	BREAD ROLL CAPACITY	GLASS CAPACITY (Ø80 mm // Ø75mm)	BRACKET	€
<b>CUTLERY DISPENSER OVER NEUTRAL ELEMENT</b>								
	DC-R-1	19071811	696x345x536	3 GN 1/3 - 150 mm	150	-	Rectangular	-
	DC-R-2	19071812	696x345x658	6 GN 1/3 - 150 mm	300	-	Rectangular	-
<b>BREAD DISPENSER OVER NEUTRAL ELEMENT</b>								
	DP-R-1	19071813	696x667x600	1 GN 2/1 - 200 mm	-	120	Rectangular	-
	DP-R-2	19071814	696x667x725	2 GN 2/1 - 200 mm	-	240	Rectangular	-
<b>CUTLERY AND BREAD DISPENSER OVER NEUTRAL ELEMENT</b>								
	DCP-R	19071815	696x667x658	3 GN 1/3 - 150 mm + 1 GN 2/1 - 200 mm	150	120	Rectangular	-
<b>GLASS DISPENSER OVER NEUTRAL ELEMENT</b>								
	DV-R-4 SB	19071816	696x745x829	4 glass levels	-	-	216/240	Rectangular

# Neutral Elements

## General characteristics

- Manufactured with a sturdy, high-quality, stainless steel structure.
- 900 mm height, 1.5 mm thickness stainless steel worktop in satin finish.
- 800 mm height tray slider. Made up of three (3) Ø 30 mm stainless steel round tubes.
- Food grade, waterproof, elastic, silicone joint placed between the worktops to ensure a precise adjustment.
- Facade decoration with laminated panels to be chosen from 16 basic colors.
- Front panels in water-resistant medium density fibreboard (MDF).
- Decoration facade at 150 mm from the ground.
- Plinths, end of line decoration or any other accessories should be requested separately and are supplied disassembled.



SM-4



SA-I-45



SA-E-90

MODEL	CODE	DIMENSIONS (mm)	DESCRIPTION	CAPACITY GN 1/1	€
<b>NEUTRAL ELEMENT</b>					
SM-450	18001494	450x850x900	Closed without neutral reserve	-	-
SM-2	18001495	950x850x900	Open / neutral reserve	2	-
SM-3	18001496	1375x850x900	Open / neutral reserve	3	-
SM-4	18001497	1600x850x900	Open / neutral reserve	4	-
SM-5	18001498	1985x850x900	Open / neutral reserve	5	-
SM-6	18001499	2335x850x900	Open / neutral reserve	6	-
SM-3-P	18001500	1375x850x900	Neutral reserve with 2 sliding doors and 1 optional intermediate shelf	3	-
SM-4-P	18001501	1600x850x900	Neutral reserve with 2 sliding doors and 1 optional intermediate shelf	4	-
SM-5-P	18001502	1985x850x900	Neutral reserve with 2 sliding doors and 1 optional intermediate shelf	5	-
SM-6-P	18001503	2335x850x900	Neutral reserve with 2 sliding doors and 1 optional intermediate shelf	6	-
<b>CORNER ELEMENT</b>					
SA-I-90	18001504	1141x1141x900	90° internal angle. Open / neutral reserve	-	-
SA-I-45	18001505	850x850x900	45° internal angle. Open / neutral reserve	-	-
SA-E-90	18001506	935x935x900	90° external angle. Without neutral reserve	-	-
SA-E-45	18001507	850x850x900	45° external angle. Without neutral reserve	-	-



SMC-12-D



SMC-8-F



DAC-95



DPAN-95

MODEL	CODE	DIMENSIONS (mm)	DESCRIPTION	€
<b>CASH REGISTER ELEMENT</b>				
SMC-12-D	18001514	1375x850x900	Cash register element with side arm to the right	-
SMC-12-I	18001516	1375x850x900	Cash register element with side arm to the left	-
SMC-6-D	18001519	605x850x900	Cash register element without side arm (cash register to the right)	-
SMC-6-I	18001520	605x850x900	Cash register element without side arm (cash register to the left)	-
SMC-8-F	18001521	800x850x900	Cash register element without side arm (cash register facing public)	-

MODEL	CODE	DIMENSIONS (mm)	DESCRIPTION	€
<b>FACADE ELEMENT</b>				
F-5	18001720	550x215x900	Facade element= 550 mm	-

MODEL	CODE	DIMENSIONS (mm)	DESCRIPTION	PLATE CAPACITY (Ø280mm)	GLASS CAPACITY (Ø80/Ø75mm)	MAXIMUM LOAD (KG)	POWER (W)	€
<b>PLATE DISPENSER</b>								
DAN-95	18001508	950x850x900	2 plate columns - neutral	80-90	-	45 per column	-	-
DAC-95	18001509	950x850x900	2 plate columns - heated	80-90	-	45 per column	960	-
<b>GLASS BASKET DISPENSER</b>								
DPAN-95	18001510	950x850x900	5/6 glass baskets	-	200 // 265	120	-	-



# Refrigerated Elements

## General characteristics

- Refrigerated elements specially designed to hold, display and serve chilled food during service time
- Counter framework manufactured with a sturdy, high-quality, full stainless steel structure.
- 900 mm height, 1.5 mm thickness stainless steel worktop in satin finish.
- 800 mm height tray slider. Made up of three (3) Ø 30 mm stainless steel round tubes.
- Food grade, waterproof, elastic, silicone joint placed between the worktops to ensure a precise adjustment.
- Front panels in water-resistant medium density fibreboard (MDF).
- Facade decoration with laminated panels to be chosen from 16 basic colors.
- Decoration facade at 150 mm from the ground.
- Static well cooling system by expanded copper coil located on its base.
- Ventilated well cooling system creates a constant flow of chilled air, coming from the evaporator module fans.
- Polyurethane insulation with ecological injection, CFC-free, with high-density (40 kg/m³).
- Electronic thermostat with digital display.
- Electrical components in a single, easy-access point to enable maintenance operations.
- Junction box housing electrical connections providing a centralized access of all technical powered elements.
- Plinths or any other accessories should be requested separately and are supplied disassembled.



DSCSP-CR-4

MODEL	GAS	HZ	CODE	DIMENSIONS (mm)	WELL DEPTH (mm)	CAPACITY GN 1/1	RESERVE	POWER (W)	CLIMATE CLASS	COLD GROUP	€
STATIC REFRIGERATED PLATE ELEMENT											
DSCSP-SR-3	R290	50/60	18007711	1375x850x900	-	3	Open / neutral reserve	215	4	Included	-
DSCSP-SR-4	R290	50/60	18007712	1600x850x900	-	4	Open / neutral reserve	225	4	Included	-
 DSCSP-SR-5	R290	50/60	18007713	1985x850x900	-	5	Open / neutral reserve	305	4	Included	-
DSCSP-SR-6	R290	50/60	18007714	2335x850x900	-	6	Open / neutral reserve	330	4	Included	-
DSCSP-CR-3	R290	50/60	18007715	1375x850x900	-	3	1 x GN2/1 refrigerated reserve	380	4	Included	-
DSCSP-CR-4	R290	50/60	18007716	1600x850x900	-	4	1 x GN2/1 refrigerated reserve	390	4	Included	-
 DSCSP-CR-5	R290	50/60	18007717	1985x850x900	-	5	2 x GN2/1 refrigerated reserve	575	4	Included	-
DSCSP-CR-6	R290	50/60	18007718	2335x850x900	-	6	2 x GN2/1 refrigerated reserve	600	4	Included	-





FSCV-SR-4



FSCR-4 + SP-70



FSCV-4 + SP-70

MODEL	GAS	HZ	CODE	DIMENSIONS (mm)	WELL DEPTH(mm)	CAPACITY GN 1/1	RESERVE	POWER (W)	CLIMATE CLASS	COLD GROUP	€
VENTILATED REFRIGERATED WELL ELEMENT											
FSCV-SR-3	R290	50/60	18004636	1375x850x900	35- 82-120	3	Open / neutral reserve	375	4	Included	-
FSCV-SR-4	R290	50/60	18004637	1600x850x900	35- 82-120	4	Open / neutral reserve	380	4	Included	-
 FSCV-SR-5	R290	50	18004638	1985x850x900	35- 82-120	5	Open / neutral reserve	485	4	Included	-
FSCV-SR-6	R290	50	18004639	2335x850x900	35- 82-120	6	Open / neutral reserve	510	4	Included	-
FSCV-CR-3	R290	50/60	18004640	1375x850x900	35- 82-120	3	1 x GN2/1 refrigerated reserve	525	4	Included	-
FSCV-CR-4	R290	50/60	18004641	1600x850x900	35- 82-120	4	1 x GN2/1 refrigerated reserve	530	4	Included	-
 FSCV-CR-5	R290	50	18004642	1985x850x900	35- 82-120	5	2 x GN2/1 refrigerated reserve	695	4	Included	-
FSCV-CR-6	R290	50	18004643	2335x850x900	35- 82-120	6	2 x GN2/1 refrigerated reserve	720	4	Included	-
ISLAND-TYPE STATIC REFRIGERATED WELL ELEMENT											
FSCR-3	R290	50/60	18004684	1265x875x900	80	3	-	215	4	Included	-
FSCR-4	R290	50/60	18004685	1590x875x900	80	4	-	225	4	Included	-
 FSCR-5	R290	50/60	18004686	1975x875x900	80	5	-	305	4	Included	-
FSCR-6	R290	50/60	18004687	2325x875x900	80	6	-	330	4	Included	-
ISLAND-TYPE VENTILATED REFRIGERATED WELL ELEMENT											
FSCV-3	R290	50/60	18004688	1265x875x900	35- 82-120	3	-	375	4	Included	-
FSCV-4	R290	50/60	18004689	1590x875x900	35- 82-120	4	-	380	4	Included	-
 FSCV-5	R290	50	18004690	1975x875x900	35- 82-120	5	-	485	4	Included	-
FSCV-6	R290	50	18004691	2325x875x900	35- 82-120	6	-	510	4	Included	-

# Hot Elements

## General characteristics

- Hot elements specially designed to hold, display and serve hot food during service time
- Counter framework manufactured with a sturdy, high-quality, full stainless steel structure.
- 900 mm height, 1.5 mm thickness stainless steel worktop in satin finish.
- 800 mm height tray slider. Made up of three (3) Ø 30 mm stainless steel round tubes.
- Food grade, waterproof, elastic, silicone joint placed between the worktops to ensure a precise adjustment.
- Front panels in water-resistant medium density fibreboard (MDF).
- Facade decoration with laminated panels to be chosen from 16 basic colors.
- Decoration facade at 150 mm from the ground.

- Glass ceramic top heating system by hidden silicon resistors attached to the bottom of the plate.
- Dry bain marie heating system by a set of resistor modules with fans.
- Wet bain marie heating system by hidden silicon resistors attached to the bottom of the well.
- Electronic thermostat with digital display.
- Electrical components in a single, easy-access point to enable maintenance operations.
- Junction box housing electrical connections providing a centralized access of all technical powered elements.
- Plinths or any other accessories should be requested separately and are supplied disassembled.



SV-SR-4

MODEL	VOLTAGE AND FREQUENCY (HZ)	CODE	DIMENSIONS (mm)	CAPACITY GN 1/1	RESERVE	POWER(W)	€
GLASS CERAMIC PLATE HOT ELEMENT							
SV-SR-2	230V 1N 50/60	18001658	950x850x900	2	Open / neutral reserve	905	-
SV-SR-3	230V 1N 50/60	18001610	1375x850x900	3	Open / neutral reserve	1355	-
SV-SR-4	230V 1N 50/60	18001611	1600x850x900	4	Open / neutral reserve	1805	-
SV-SR-5	230V 1N 50/60	18001612	1985x850x900	5	Open / neutral reserve	2255	-
SV-SR-6	230V 1N 50/60	18001613	2335x850x900	6	Open / neutral reserve	2710	-
SV-CR-3	230V 1N 50/60	18001614	1375x850x900	3	Hot reserve	2805	-
SV-CR-4	230V 1N 50/60	18001615	1600x850x900	4	Hot reserve	3255	-
SV-CR-5	400V 3N 50/60	18001616	1985x850x900	5	Hot reserve	4275	-
SV-CR-6	400V 3N 50/60	18001617	2335x850x900	6	Hot reserve	5710	-



SBM-SR-4



DSHV-SR-4



SV-4 + SP-70

MODEL	VOLTAGE AND FREQUENCY (HZ)	CODE	DIMENSIONS (mm)	WELL DEPTH(mm)	CAPACITY GN 1/1	RESERVE	POWER(W)	€
WET BAIN MARIE HOT ELEMENT								
SBM-SR-2	230V 1N 50/60	18001618	950x850x900	190	2	Open / neutral reserve	1510	-
SBM-SR-3	230V 1N 50/60	18001619	1375x850x900	190	3	Open / neutral reserve	2005	-
SBM-SR-4	230V 1N 50/60	18001620	1600x850x900	190	4	Open / neutral reserve	2510	-
SBM-SR-5	230V 1N 50/60	18001621	1985x850x900	190	5	Open / neutral reserve	3030	-
SBM-SR-6	230V 1N 50/60	18001622	2335x850x900	190	6	Open / neutral reserve	3555	-
SBM-CR-3	230V 1N 50/60	18001623	1375x850x900	190	3	Hot reserve	2905	-
SBM-CR-4	230V 1N 50/60	18001624	1600x850x900	190	4	Hot reserve	3360	-
SBM-CR-5	400V 3N 50/60	18001625	1985x850x900	190	5	Hot reserve	4480	-
SBM-CR-6	400V 3N 50/60	18001626	2335x850x900	190	6	Hot reserve	5245	-
DRY BAIN MARIE HOT ELEMENT								
DSHV-SR-3	230V 1N 50/60	18007737	1375x850x900	234	3	Open / neutral reserve	1250	-
DSHV-SR-4	230V 1N 50/60	18007738	1600x850x900	234	4	Open / neutral reserve	1250	-
DSHV-SR-5	230V 1N 50/60	18007739	1985x850x900	234	5	Open / neutral reserve	2050	-
DSHV-SR-6	230V 1N 50/60	18007741	2335x850x900	234	6	Open / neutral reserve	2050	-
DSHV-CR-3	230V 1N 50/60	18007742	1375x850x900	234	3	Hot reserve	2100	-
DSHV-CR-4	230V 1N 50/60	18007743	1600x850x900	234	4	Hot reserve	2100	-
DSHV-CR-5	230V 1N 50/60	18007744	1985x850x900	234	5	Hot reserve	3500	-
DSHV-CR-6	400V 3N 50/60	18007745	2335x850x900	234	6	Hot reserve	3740	-
ISLAND-TYPE GLASS CERAMIC PLATE HOT ELEMENT								
SV-3	230V 1N 50/60	18001643	1265x875x900	-	3	-	1355	-
SV-4	230V 1N 50/60	18001644	1590x875x900	-	4	-	1805	-
SV-5	230V 1N 50/60	18001645	1975x850x900	-	5	-	2255	-
SV-6	230V 1N 50/60	18001646	2325x875x900	-	6	-	2710	-



# 3-level cubic refrigerated ventilated vitrines

## General characteristics

- Refrigerated displays specially designed to hold, display and serve chilled food and beverages during service time.
- Counter framework manufactured with a sturdy, high-quality, full stainless steel structure.
- 900 mm height, 1.5 mm thickness stainless steel worktop in satin finish.
- 800 mm height tray slider. Made up of three (3) Ø 30 mm stainless steel round tubes.
- Food grade, waterproof, elastic, silicone joint placed between the worktops to ensure a precise adjustment.
- Front panels in water-resistant medium density fibreboard (MDF).
- Facade decoration with laminated panels to be chosen from 16 basic colors.
- Decoration facade at 150 mm from the ground.
- Ventilated display cooling system creates a constant flow of chilled air at the back side of the display coming from the evaporator module fans.
- Polyurethane insulation with ecological injection, CFC-free, with high-density (40 kg/m³).
- 8 mm thickness tempered glass shelves.
- Back display doors allowing an easy product access.
- Electronic thermostat with digital display.
- Electrical components in a single, easy-access point to enable maintenance operations.
- Junction box housing electrical connections providing a centralized access of all technical powered elements.
- Plinths or any other accessories should be requested separately and are supplied disassembled.



DSRVC-H-SR-CT-3-4



DSRVC-S-CR-CT-3-4

### Client side: TEXTILE CURTAIN (CT)

MODEL	GAS	HZ	CODE	DIMENSIONS (mm)	CAPACITY GN 1/1	RESERVE	CUSTOMER SIDE	POWER (W)	CLIMATE CLASS	COLD GROUP	€
SERVICE SIDE: SWING DOORS (H)											
DSRVC-H-SR-CT-3-3	R290	50	18007719	1375x850x1722	3	Open / Neutral reserve	Textile curtain	970	3M2	Included	-
DSRVC-H-SR-CT-3-4	R290	50	18007721	1600x850x1722	4	Open / Neutral reserve	Textile curtain	1200	3M2	Included	-
DSRVC-H-CR-CT-3-3	R290	50	18007724	1375x850x1722	3	1 GN2/1 refrigerated reserve	Textile curtain	1120	3M2	Included	-
DSRVC-H-CR-CT-3-4	R290	50	18007725	1600x850x1722	4	1 GN2/1 refrigerated reserve	Textile curtain	1350	3M2	Included	-
SERVICE SIDE: SLIDING DOORS (S)											
DSRVC-S-SR-CT-3-3	R290	50	18007728	1375x850x1710	3	Open / Neutral reserve	Textile curtain	665	3M2	Included	-
DSRVC-S-SR-CT-3-4	R290	50	18007729	1600x850x1710	4	Open / Neutral reserve	Textile curtain	1200	3M2	Included	-
DSRVC-S-CR-CT-3-3	R290	50	18007732	1375x850x1710	3	1 GN2/1 refrigerated reserve	Textile curtain	810	3M2	Included	-
DSRVC-S-CR-CT-3-4	R290	50	18007733	1600x850x1710	4	1 GN2/1 refrigerated reserve	Textile curtain	1350	3M2	Included	-

### Client side: CLAPETS (CP)

MODEL	GAS	HZ	CODE	DIMENSIONS (mm)	CAPACITY GN 1/1	RESERVE	CUSTOMER SIDE	POWER (W)	CLIMATE CLASS	COLD GROUP	€
SERVICE SIDE: SWING DOORS (H)											
DSRVC-H-SR-CP-3-3	R290	50	18007722	1375x850x1722	3	Open / Neutral reserve	Clapets	970	3M1	Included	-
DSRVC-H-SR-CP-3-4	R290	50	18007723	1600x850x1722	4	Open / Neutral reserve	Clapets	1200	3M1	Included	-
DSRVC-H-CR-CP-3-3	R290	50	18007726	1375x850x1722	3	1 GN2/1 refrigerated reserve	Clapets	1120	3M1	Included	-
DSRVC-H-CR-CP-3-4	R290	50	18007727	1600x850x1722	4	1 GN2/1 refrigerated reserve	Clapets	1350	3M1	Included	-
SERVICE SIDE: SLIDING DOORS (S)											
DSRVC-S-SR-CP-3-3	R290	50	18007730	1375x850x1710	3	Open / Neutral reserve	Clapets	665	3M1	Included	-
DSRVC-S-SR-CP-3-4	R290	50	18007731	1600x850x1710	4	Open / Neutral reserve	Clapets	1200	3M1	Included	-
DSRVC-S-CR-CP-3-3	R290	50	18007734	1375x850x1710	3	1 GN2/1 refrigerated reserve	Clapets	810	3M1	Included	-
DSRVC-S-CR-CP-3-4	R290	50	18007736	1600x850x1710	4	1 GN2/1 refrigerated reserve	Clapets	1350	3M1	Included	-

# Cubic hot vitrines

## General characteristics

- Hot displays specially designed to hold, display and serve hot food during service time.
- Counter framework manufactured with a sturdy, high-quality, full stainless steel structure.
- 900 mm height, 1.5 mm thickness stainless steel worktop in satin finish.
- 800 mm height tray slider. Made up of three (3) Ø 30 mm stainless steel round tubes.
- Food grade, waterproof, elastic, silicone joint placed between the worktops to ensure a precise adjustment.
- Front panels in water-resistant medium density fibreboard (MDF).
- Facade decoration with laminated panels to be chosen from 16 basic colors.
- Decoration facade at 150 mm from the ground.
- Hot display heating system by hidden silicon resistors attached to the bottom of the glass ceramic plate and shelves.
- Foodshields with light and heat by protected halogen lamps located over the glass ceramic plate and shelves.
- Three (3) electronic thermostats, with digital display, to control and regulate the temperature on the glass ceramic plate and on the shelves separately, at the desired set point.
- Electrical components in a single, easy-access point to enable maintenance operations.
- Junction box housing electrical connections providing a centralized access of all technical powered elements.
- Plinths or any other accessories should be requested separately and are supplied disassembled.



DSHVC-S-SR-3-4



DSHVC-S-CR-3-4

MODEL	VOLTAGE AND FREQUENCY (HZ)	CODE	DIMENSIONS (mm)	CAPACITY GN 1/1	RESERVE	CUSTOMER SIDE	POWER (W)	€
CUBIC HOT GLASS CERAMIC DISPLAY								
DSHVC-S-SR-3-3	400V 3N 50/60	18007746	1375x850x1717	3	Open / neutral reserve	Open	3620	-
DSHVC-S-SR-3-4	400V 3N 50/60	18007747	1600x850x1717	4	Open / neutral reserve	Open	4970	-
DSHVC-S-SR-3-5	400V 3N 50/60	18007748	1925x850x1717	5	Open / neutral reserve	Open	6320	-
DSHVC-S-CR-3-3	400V 3N 50/60	18007749	1375x850x1717	3	Hot reserve	Open	5070	-
DSHVC-S-CR-3-4	400V 3N 50/60	18007750	1600x850x1717	4	Hot reserve	Open	6420	-
DSHVC-S-CR-3-5	400V 3N 50/60	18007751	1925x850x1717	5	Hot reserve	Open	8790	-

# Foodshield with shelf and protection frontal glass

## General characteristics

- Foodshields specially designed to improve food hygiene as well as to guarantee guest protection.
- Stainless steel shelf.
- Brackets manufactured in stainless steel, in rectangular tube.
- 35 mm distance between bracket and foodshield to make cleaning operations easier.
- Brackets are easily mounted on the structure by means of threaded plates.
- Easy installation of glasses to foodshields by means of clamps.



MODEL	HZ	CODE	DIMENSIONS (mm)	CAPACITY GN 1/1	FUNCTION	TYPE	BRACKET	POWER (W)	€
<b>NEUTRAL FOODSHIELD WITH STAINLESS STEEL SHELF AND PROTECTION FRONTAL GLASS</b>									
DSFS-R-2	-	19106268	19106268	2	Neutral	Stainless steel shelf	Rectangular	-	-
DSFS-R-3	-	19106269	19106269	3	Neutral	Stainless steel shelf	Rectangular	-	-
DSFS-R-4	-	19106270	19106270	4	Neutral	Stainless steel shelf	Rectangular	-	-
DSFS-R-5	-	19106271	19106271	5	Neutral	Stainless steel shelf	Rectangular	-	-
DSFS-R-6	-	19106272	19106272	6	Neutral	Stainless steel shelf	Rectangular	-	-
<b>LIGHT FOODSHIELD WITH STAINLESS STEEL SHELF AND PROTECTION FRONTAL GLASS</b>									
DSFLS-R-2	50/60	19106253	764x540x446	2	Light	Stainless steel shelf	Rectangular	15	-
DSFLS-R-3	50/60	19106254	1089x540x446	3	Light	Stainless steel shelf	Rectangular	25	-
DSFLS-R-4	50/60	19106255	1414x540x446	4	Light	Stainless steel shelf	Rectangular	35	-
DSFLS-R-5	50/60	19106256	1739x540x446	5	Light	Stainless steel shelf	Rectangular	45	-
DSFLS-R-6	50/60	19106257	2064x540x446	6	Light	Stainless steel shelf	Rectangular	55	-
<b>LIGHT AND HALOGEN HEAT FOODSHIELD WITH STAINLESS STEEL SHELF AND PROTECTION FRONTAL GLASS</b>									
DSFHS-R-2	50/60	19106258	764x540x446	2	Light and heat	Stainless steel shelf	Rectangular	600	-
DSFHS-R-3	50/60	19106259	1089x540x446	3	Light and heat	Stainless steel shelf	Rectangular	900	-
DSFHS-R-4	50/60	19106260	1414x540x446	4	Light and heat	Stainless steel shelf	Rectangular	1200	-
DSFHS-R-5	50/60	19106261	1739x540x446	5	Light and heat	Stainless steel shelf	Rectangular	1500	-
DSFHS-R-6	50/60	19106262	2064x540x446	6	Light and heat	Stainless steel shelf	Rectangular	1500	-
<b>LIGHT AND CERAMIC HEAT FOODSHIELD WITH STAINLESS STEEL SHELF AND PROTECTION FRONTAL GLASS</b>									
DSFCS-R-2	50/60	19106263	764x540x446	2	Light and ceramic heat	Stainless steel shelf	Rectangular	650	-
DSFCS-R-3	50/60	19106264	1089x540x446	3	Light and ceramic heat	Stainless steel shelf	Rectangular	1050	-
DSFCS-R-4	50/60	19106265	1414x540x446	4	Light and ceramic heat	Stainless steel shelf	Rectangular	1450	-
DSFCS-R-5	50/60	19106266	1739x540x446	5	Light and ceramic heat	Stainless steel shelf	Rectangular	1850	-
DSFCS-R-6	50/60	19106267	2064x540x446	6	Light and ceramic heat	Stainless steel shelf	Rectangular	1850	-

## Foodshields and glasses

See foodshields and glasses options in the Drop in section.



## Accessories



ESN-4



ES-I-90



CJL-2



ITDP-28

### Neutral elements accessories

MODEL	CODE	DIMENSIONS (MM)	DESCRIPTION	€
<b>NEUTRAL ELEMENTS ACCESSORIES</b>				
ESN-2	19037886	644x670	Height-adjustable shelf for SM-2	-
ESN-3	19037883	1068x670	Height-adjustable shelf for SM-3	-
ESN-4	19037884	1294x670	Height-adjustable shelf for SM-4	-
ESN-5	19037885	1679x670	Height-adjustable shelf for SM-5	-
ESN-6	19042746	2029x670	Height-adjustable shelf for SM-6	-
ESN-3-P	19070426	1068x670	Height-adjustable shelf for SM-3-P	-
ESN-4-P	19070427	1294x670	Height-adjustable shelf for SM-4-P	-
ESN-5-P	19070428	1679x670	Height-adjustable shelf for SM-5-P	-
ESN-6-P	19070429	2029x670	Height-adjustable shelf for SM-6-P	-

### CORNER ELEMENTS ACCESSORIES

ES-I-45	19037895	578x530	Height-adjustable shelf for SA-I-45	-
ES-I-90	19037894	1162x591	Height-adjustable shelf for SA-I-90	-

### CASH REGISTER ELEMENTS ACCESSORIES

CJL-1	19046593	311x401x111	Drawer with lock for SMC-16, SMC-6-D, SMC-6-I, SMC-8-F	-
CJL-2	19046594	311x401x111	Drawer with lock for SMC-12-D, SMC-12-I	-

### PLATE DISPENSERS ACCESSORIES

ITDP-28	19043374	Ø 400x60	Lid covers for plate dispenser with Ø 280 mm	-
---------	----------	----------	--	---

### Refrigerated elements accessories

MODEL	CODE	DIMENSIONS (mm)	DESCRIPTION	POWER (W)	€
<b>ACCESSORIES FOR REFRIGERATED ELEMENTS, ISLANDS AND DISPLAYS</b>					
ESF-3	19046585	534x670	Height-adjustable shelf for 3 GN 1/1	-	-
ESF-4	19046586	759x670	Height-adjustable shelf for 4 GN 1/1	-	-
ESF-5/6	19046587	1144x670	Height-adjustable shelf for 5 o 6 GN 1/1	-	-
SP-70	19043113	680x250x170	Stainless steel plate rack shelf for island-type elements	-	-
<b>EVAPORATION KITS</b>					
EV-KIT-450	19046595	400x170x65	Static refrigerated elements, ventilated refrigerated wells and 3GN 1/1 vitrines with textile curtain (CT) or clapets (CP).	450	-
EV-KIT-900	19046596	400x170x65	4 GN 1/1 vitrines with textile curtain (CT) or clapets (CP)	900	-

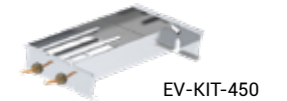

EV-KIT-450

### Hot elements accessories

MODEL	VOLTAGE AND FREQUENCY (HZ)	CODE	DIMENSIONS (mm)	DESCRIPTION	POWER (W)	€
<b>UNDERCOUNTER HOT TROLLEYS</b>						
ICCB-6	230V 1N 50-60	19043639	685x670x730	1 door. Capacity 6 GN 2/1 guides.	850	-
ICCB-6-3C	230V 1N 50-60	19043641	685x670x730	3 drawers. Capacity 3 GN 1/1 pans.	850	-
<b>HOT ELEMENTS ACCESSORIES</b>						
ESC-2	-	19046588	412x670	Height-adjustable shelf for 2 GN 1/1	-	-
ESC-3	-	19046589	837x670	Height-adjustable shelf for 3 GN 1/1	-	-
ESC-4	-	19046590	1062x670	Height-adjustable shelf for 4 GN 1/1	-	-
ESC-5	-	19046591	1447x670	Height-adjustable shelf for 5 GN 1/1	-	-
ESC-6	-	19046592	1797x670	Height-adjustable shelf for 6 GN 1/1	-	-
SP-70	-	19043113	680x250x170	Stainless steel plate rack shelf for island-type elements	-	-



Z-3GN



DDATCS



DBFLI

MODEL	CODE	APPLIES TO	€	MODEL	CODE	APPLIES TO	€
Z-SS-77-ISL	19046603	Dispenser over base 798 mm	-	Z-2GN-LW	19046612	950 mm element	-
Z-SS-147-ISL	19046604	Dispenser over base 1450 mm	-	Z-2GN-L2W	19046613	950 mm element	-
Z-SM-450	19046605	SM-450	-	Z-3GN	19046614	1375 mm element	-
Z-SM-450-LW	19046606	SM-450	-	Z-3GN-LW	19046615	1375 mm element	-
Z-SM-450-L2W	19046607	SM-450	-	Z-3GN-L2W	19046616	1375 mm element	-
Z-SA-I-90	19046630	90° internal angle. Open / neutral reserve	-	Z-4GN	19046617	1600 mm element	-
Z-SA-I-45	19046631	45° internal angle. Open / neutral reserve	-	Z-4GN-LW	19046618	1600 mm element	-
Z-SA-E-90	19046632	90° external angle. Without neutral reserve	-	Z-4GN-L2W	19046619	1600 mm element	-
Z-SA-E-45	19046633	45° external angle. Without neutral reserve	-	Z-5GN	19046620	1985 mm element	-
Z-F-5	19046608	F-5	-	Z-5GN-LW	19046621	1985 mm element	-
Z-F-5-LW	19046609	F-5	-	Z-5GN-L2W	19046622	1985 mm element	-
Z-SMC-12 L2W	19070149	SMC-12-D, SMC-12-I	-	Z-6GN	19046623	2335 mm element	-
Z-SMC-12 LWS	19070290	SMC-12-D, SMC-12-I	-	Z-6GN-LW	19046624	2335 mm element	-
Z-SMC-8	19046638	SMC-8-F	-	Z-6GN-L2W	19046625	2335 mm element	-
Z-SMC-8-LW	19046639	SMC-8-F	-	Z-3GN-ISL	19046626	1265 mm island-type element	-
Z-SMC-8-L2W	19046640	SMC-8-F	-	Z-4GN-ISL	19046627	1590 mm island-type element	-
Z-SMC-6	19046634	SMC-6-D, SMC-6-I	-	Z-5GN-ISL	19046628	1975 mm island-type element	-
Z-SMC-6-ISL	19070293	SMC-6-D, SMC-6-I	-	Z-6GN-ISL	19046629	2325 mm island-type element	-
Z-2GN	19046611	950 mm element	-				

MODEL	DESCRIPTION
-	Plinth on customer side of the element.
LW	Plinth on customer side and one (1) side of the element.
L2W	Plinth on customer side and two (2) sides of the element.
ISL	Plinth on four (4) sides of the element.
LWS	Plinth on customer side and one (1) short side of the element.

MODEL	HZ	CODE	DIMENSIONS (mm)	DESCRIPTION	POWER (W)	€
DIGITAL THERMOMETER KIT						
IPCIC	50/60	19053060	132x84x70	Switch	-	-
DDATC	50/60	19105738	132x84x70	Thermometer (cold)	-	-
DDATCS	50/60	19105739	132x84x70	Thermometer (cold)	-	-
DDATH	50/60	19105740	132x84x70	Thermometer (hot)	-	-
DDATHS	50/60	19105741	132x84x70	Thermometer (hot) - Switch	-	-

MODEL	CODE	DESCRIPTION	€
END OF LINE DECORATION			
DBFLI	19080942	Basic color decoration end of line left	-
DBFLD	19080943	Basic color decoration end of line right	-

# Configuration options

## Facade decoration

- ODF0020\_BF Facade decorated with laminated panels in color. To be chosen from 16 basic colors:

- BF3091 Crystal White
- BF7927 Folkestone
- BF7912 Storm
- BF2253 Diamond Black
- BF7940 Spectrum Yellow
- BF3210 Levante
- BF1238 Carnaval
- BF6907 Amarena
- BF4177 Lemon
- BF8755 Lime
- BF6901 Vibrant Green
- BF0187 Kashmir
- BF5347 Maui
- BF1326 Capri
- BF5127 Monaco
- BF0157 Tahiti



## Castors

- OBF0011+OBF0012 Sound-proof stainless steel swivel castors.
- OBF0011 Swivel castor with brake.
- OBF0012 Swivel castor without brake.



## Automatic filling function for bain marie

- OBM0010 Automatic filling function and level detector for bain marie elements.



# Distribution trolleys

Neutral trolleys.....	415
— Service trolleys.....	415
— Racking trolleys.....	416
— Self service tray trolleys.....	417
— Plate trolleys.....	418
— Plate stacking trolleys .....	419
— Transport trolley.....	420
— Waste cabinets.....	420
— Waste bins .....	420
Holding temperature trolleys .....	421
— Hot trolleys with humidity control.....	421
— Hot trolleys for distribution.....	422
— Refrigerated trolleys for distribution .....	423



Your kitchen on  
the move.



Access the website



## Service trolleys



TS-2-610



TS-3-610



TS-4-610

### General characteristics

- Made entirely from AISI-304 18/10 stainless steel with satin finish.
- Robust, sound-proof, single-pressed shelf with perimeter folding.
- Four (4) Ø125 mm sound-proof castors, two (2) with brakes, with non-marking rubber bumpers.
- Capacity to bear loads of 70 kg per shelf, with a maximum of 200 kg per trolley (distributed loads).
- **Supplied assembled.**

	MODEL	CODE	DIMENSIONS (mm)	SHELF DIMENSIONS (mm)	€
<b>2 SHELVES</b>					
	TS-2-58	19092937	895x595x975	800x500	-
	TS-2-59	19092938	995x595x975	900x500	-
	TS-2-610	19092939	1095x695x975	1000x600	-
<b>3 SHELVES</b>					
	TS-3-58	19092943	895x595x975	800x500	-
	TS-3-59	19092944	995x595x975	900x500	-
	TS-3-610	19092945	1095x695x975	1000x600	-
<b>4 SHELVES</b>					
	TS-4-59	19092949	995x595x1270	900x500	-
	TS-4-610	19092950	1095x695x1270	1000x600	-

### Service trolley accessories

- Made from stainless steel.
- Easy to fit on all TS standard service trolleys.

595mm WIDTH TROLLEY			695mm WIDTH TROLLEY			DESCRIPTION
MODEL	CODE	€	MODEL	CODE	€	
TAG5	19092951	225	TAG6	19097562	-	Garbage bag holder
TAC5	19092952	131	TAC6	19097563	-	Cutlery holder. Includes 4 baskets and stainless steel pan.



TAC

TAG

## Racking trolleys

### General characteristics

- Made entirely from stainless steel with satin finish.
- U-shaped guide rails to avoid pans from falling during pan removal.
- End stop bars to avoid pans from shifting during transportation.
- Four (4) Ø125 mm sound-proof castors, two (2) with brakes, with non-marking rubber bumpers.

### GN trolleys

- Gastronorm pans not included.
- 75mm distance between guides.

ASSEMBLED TROLLEY			DISASSEMBLED TROLLEY			DIMENSIONS (mm)	PANS SIZE	NO. GUIDES
MODEL	CODE	€	MODEL	CODE	€			
TTT11-17	19106191	-	TTTD11-17	19092953	-	455x640x1700	GN 1/1	18
TTT21-17	19106192	-	TTTD21-17	19092954	-	660x760x1700	GN 2/1	18
TTT11-9	19106193	-	TTTD11-9	19092957	-	455x640x900	GN 1/1	8
TTT21-9	19106194	-	TTTD21-9	19092958	-	660x760x900	GN 2/1	8



TTT11-17



TTT11-9

### Nestable GN pan trolleys

- Specially designed for the storage of trolleys that are not being used, minimizing the necessary space.
- Gastronorm pans not included.
- 75mm distance between guides.
- **Supplied assembled.**

MODEL	CODE	DIMENSIONS (mm)	PANS SIZE	NO. GUIDES	€
TTTTF21-17	19092956	660x760x1720	GN 2/1	18	-



TTTTF21-17

### Pastry trolleys

- Pastry pans not included.
- 85mm distance between guides.

ASSEMBLED TROLLEY			DISASSEMBLED TROLLEY			DIMENSIONS (mm)	NO. GUIDES
MODEL	CODE	€	MODEL	CODE	€		
TTT64-17	19106195	-	TTTD64-17	19092955	-	530x700x1720	16
TTT64-9	19106196	-	TTTD64-9	19092959	-	530x700x990	8



TTT64-17



TTT64-9

### Tablotherm pan trolleys

- Tablotherm pans not included.
- 140 mm distance between guides.

ASSEMBLED TROLLEY			DISASSEMBLED TROLLEY			DIMENSIONS (mm)	NO. GUIDES
MODEL	CODE	€	MODEL	CODE	€		
TTT53-10	19106197	-	TTTD53-10	19097621	-	505x640x1720	10
TTT53-20	19106198	-	TTTD53-20	19097623	-	915x640x1720	20



TTT53-20



TTT53-10

## Dishwashing basket trolleys

- Specially designed to store and transport of standard 500 x 500 mm dishwasher baskets.
- Baskets not included.
- 203mm distance between guides.

ASSEMBLED TROLLEY			DISASSEMBLED TROLLEY			DIMENSIONS (mm)	NO. GUIDES
MODEL	CODE	€	MODEL	CODE	€		
TT55-17	19106199	-	TTD55-17	19092960	-	631x640x1720	7



TT55-17

## Racking trolley covers

- Transparent PVC cover, 200 microns thick.
- Zip closure.

MODEL	CODE	DIMENSIONS (mm)	DESCRIPTION	€
PC11-17	19092965	455x640x1700	PVC cover for TTT11(D)-17	-
PC21-17	19092966	660x760x1700	PVC cover for TTT21(D)-17	-
PC64-17	19092967	530x700x1720	PVC cover for TTT64 (D)-17	-
PC55-17	19092968	631x640x1720	PVC cover for TTT55 (D)-17	-



PC55-17

## Self service tray trolleys

### General characteristics

- Made from stainless steel.
- Maximum load per level of 5 kg.
- Four (4) Ø125 mm sound-proof castors, two (2) with brakes, with non-marking rubber bumpers.
- To store trays of 450 x 350 mm, 480 x 370 mm, GN 1/1 and 350 x 270 mm, or other trays with maximum dimensions of 530 x 370 mm.
- 115mm distance between guides.
- **Supplied assembled.**

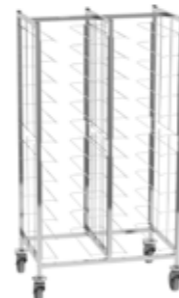

TTSA2-24

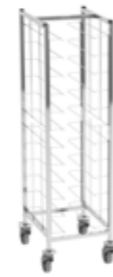

TTSA1-12

MODEL	CODE	DIMENSIONS (mm)	NO. GUIDES	€
TTSA1-12	19106210	530x640x1720	12	-
TTSA2-24	19092963	963x640x1720	12 + 12	-

## Plate trolleys

### Stainless steel trolleys

- Made from stainless steel.
- Robust structure with Ø 25 mm tube and 1.2 mm thick sheet metal. Rod welding at both ends, to be able to withstand large loads.
- Shelving inclined towards the interior to avoid dishes from falling.
- Four (4) Ø125 mm sound-proof castors, two (2) with brakes, with non-marking rubber bumpers.
- **Supplied assembled.**



TTD-150



TTD-300

MODEL	CODE	DIMENSIONS (mm)	TYPE	PLATE CAPACITY	Ø MAXIMUM PLATES (mm)	€
TTD-150	19089283	1125x570x825	Single	150	320	-
TTD-300	19089284	1125x783x825	Double	300	320/260	-

### Accessories for plate trolleys

MODEL	CODE	DESCRIPTION	€
PCD-150	19092969	PVC cover for TTD-150	-
PCD-300	19092970	PVC cover for TTD-300	-
TASR	19089285	Plate stack dividers	-



PCD-150



PCD-300



TASR

### Plastic trolleys

- Manufactured in food-grade polyethylene resistant to wear, non-marking and easy to wash.
- Thick side and rear walls, effectively protecting the plates during movement.
- Removable column divider, easy-to-adjust without the need for tooling. Storage of plates of different diameters (from 180 to 320 mm).
- Six (6) separating dividers for different organization of plates. From 45 to 60 plates in each column. 180-480 plate capacity.
- Translucent protective cover that protects the dishes stored.
- Storage, transport and unloading of dishes in a fast and ergonomic way.
- Quick access to the plate columns with both hands.
- Four (4) sound-proof castors, two (2) with brake.
- Black color.



TTDP-710

MODEL	CODE	DIMENSIONS (mm)	€
TTDP-710	19095153	1100x710x800	-

## Plate stacking trolleys

### General characteristics

- Specially designed to store and distribute a large number of dishes in a very small space.
- Made from steel with anti-rust treatment and gray epoxy finish.
- Fully welded robust structure.
- Tube in the middle, to provide maximum rigidity and make transportation easier.
- Four (4) Ø125 mm sound-proof castors, two (2) with brakes, with non-marking rubber bumpers.
- Design adjustable to plate dimensions, up to a maximum of Ø330 mm.
- Maximum capacity: 100 plates.
- Separation between levels: 60 mm.
- Hygienic plastic cover (PCP-100) that protects and keeps the trolley clean, as an accessory.
- **Supplied assembled.**

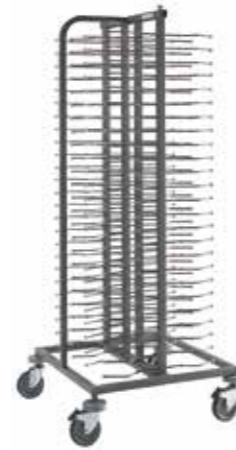

TTP-100

MODEL	CODE	DIMENSIONS (mm)	PLATE CAPACITY	€
TTP-100	19089286	754x754x1800	100	-

### Plate stacking trolley covers

- Transparent PVC cover, 200 microns thick.
- Zip closure.

MODEL	CODE	DESCRIPTION	€
PCP-100	19092972	PVC cover for TTP-100	-



PCP-100

### Wall-type plate stacking rack

- Specially designed to distribute dishes in medium-production professional kitchens.
- Made of steel with anti-rust treatment and gray epoxy finish.
- Fully welded structure.
- Small size for easy wall mounting.
- Design adjustable to plate dimensions, up to a maximum of Ø330 mm.
- Capacity: 14 plates.
- **Supplied assembled.**

MODEL	CODE	DIMENSIONS (mm)	PLATE CAPACITY	€
WP-14	19089287	300x250x880	14	-



WP-14

## Transport trolley

### Heavy-duty reinforced trolleys

- Designed to transport large loads (up to 300 kg).
- Made entirely from stainless steel.
- Four (4) Ø125 mm castors, two (2) with brakes.
- Non-marking rubber bumpers on all four corners.
- **Supplied assembled.**

MODEL	CODE	DIMENSIONS (mm)	SHELF DIMENSIONS (mm)	€
TTLL-610	19089280	1070x663x910	1000x600	-



TTLL-610

### Basket trolleys

- Designed to store and transport of 500 x 500 mm dishwashing baskets.
- Made entirely from stainless steel.
- Maximum load of 80 kg.
- Four (4) Ø125 mm sound-proof castors, two (2) with brakes.
- Non-marking rubber bumpers on all four corners.
- Dishwashing baskets not included.

MODEL	CODE	DIMENSIONS (mm)	TYPE	€
TT55-1	19089281	587x587x200	Without handle	-
TTH55-1	19089282	587x627x900	With handle	-



TTH55-1

TT55-1

### Dishwashing basket trolley covers

MODEL	CODE	DESCRIPTION	€
PC55-1	19092971	PVC cover for TT-55-1 and TTH-55-1	-



PC55-1

## Waste cabinets

- Specially designed for fast food restaurants, self-service, buffets, etc.
- Made from stainless steel.
- Ramp for easy disposal of waste to the bin.
- Space to house waste bins (not included) with a maximum dimension of Ø 500 mm x 690 mm.
- **Supplied assembled.**

MODEL	CODE	DIMENSIONS (mm)	€
FF-66	19092964	668x585x1175	-



FF-66

## Waste bins

- Made entirely from AISI 304 18/10 stainless steel.
- Single-pressed bottom with rounded edges to facilitate cleaning.
- Four (4) Ø50 mm sound-proof castors, without brakes.
- To be placed under work tables.

DIMENSIONS (mm)	CAPACITY (L)	HAND OPERATED		€	FOOT OPERATED		€
		MODEL	CODE		MODEL	CODE	
Ø 390x610	50	BSS-50	19095236	-	-	-	-
Ø 460x695	90	BSS-100	19095156	-	BSS-100 P	19095154	-





# Hot trolleys with humidity control

## General characteristics

- All parts of the trolley have been carefully analysed and tested to offer maximum temperature performance in the interior, bearing in mind the following most important requirements: ease of use, minimum maintenance and facilitation of cleaning tasks.
- Modern and intuitive electronic control panels.
- Double walled sides and door, insulated with high density polyurethane, giving great robustness and firmness.
- Recessed monoblock guides with wide radius, guaranteeing maximum hygiene.
- Efficient heat production system composed of heating element and fan.
- Recessed water reservoir with rounded corners. The heat is produced by a high-performance silicon heating element.
- 4-level humidity regulation system to adapt to the different products kept inside. The humidity system can also be fully switched off, reducing energy consumption.
- The 270° opening door offers users maximum freedom of movements and safety during daily use, increasing comfort and well-being during work operations.
- The inner door panel is completely smooth and free from any elements that might prevent thorough cleaning.
- No heat loss. Door seal fixed to the frame of the structure. Can be replaced easily without the need for tools.
- The whole perimeter is protected by a bumper, manufactured in resistant, non-marking material.
- Pivoting wheels, 2 with brakes.
- Manufactured completely in AISI-304 stainless steel.
- Heat system designed to reach the operational temperature in a very short space of time.
- Electronic membrane keypad and digital display.
- Ergonomic latch with lock.
- Modern, elegant and very robust design.
- Operational temperature 30 °C to 90 °C.
- Storage of GN 2/1 y GN 1/1 trays with depth of up to 65 mm.
- Shelves and Gastronorm pans are not included.





MODEL	VOLTAGE AND FREQUENCY	CODE	DIMENSIONS (mm)	DOORS	LEVELS GN-2/1 (SEPARATION 70 mm)	POWER (W)	€
 CCHF-10	230 V-1+N - 50/60 Hz	19044546	790x935x1.215	1	10	2.000	-
 CCHF-20	230 V-1+N - 50/60 Hz	19044549	790x935x1.855	1	20	2.000	-
 CCHF-40	230 V-1+N - 50/60 Hz	19044551	1.525x935x1.885	2	40	3.500	-

# Hot trolleys for distribution

## General characteristics

- Especially designed for maintaining and serving previously prepared hot food. Food can be hold inside the trolley directly on plates by using of rod shelves or in Gastronorm pans.
- 10, 20 or 40 GN2/1 rack rails (according to the model) with 60 mm separation between rack rails.
- Doubled wall with an injected CFC-free, ecological polyurethane 40 kg/m3 density isolation. With its highly-insulated walls, heat losses are reduced thus obtaining energy savings.
- Heating system by using two (2) forced-air electric resistors in each cabinet body to ensure that heat is distributed trough all the unit. The special design of the chamber and rack rails enables the creation of a uniform, even airflow distribution, ensuring that food is always maintained at its right temperature.
- Waveless evaporation tray system to control humidity in the chamber and prevent food from drying out.
- Thermostat and external thermometer to monitor, control and regulate the temperature at desired setpoint: from 0 °C to 90 °C.
- Horizontal handle system for fast opening and closing of door.
- Automatic locking mechanism in hinges: when door is in a position of less than a 90° angle it gets fully closed, thus avoiding loss of temperature and achieving energy savings.
- Four (4) sound-proof castors of 160 mm diameter, two of them with brakes for an easy handling and safer use. Non-marking, special rubber bumpers to protect against direct impacts along the whole trolley base.
- Key locked door.
- Made of stainless steel.
- Shelves and Gastronorm pans are not included.



MODEL	VOLTAGE AND FREQUENCY	CODE	DIMENSIONS (mm)	DOORS	LEVELS GN-2/1 (SEPARATION 60 mm)	POWER (W)	€
 CCF-10	230 V-1+N - 50/60 Hz	19036263	799x876x1.190	1	10	2.000	-
 CCF-20	230 V-1+N - 50/60 Hz	19036264	799x876x1.640	1	20	2.000	-
 CCF-40	230 V-1+N - 50/60 Hz	19036265	1.489x876x1.640	2	40	3.500	-



## Refrigerated trolleys for distribution





ECFF-20 HC



ECFF-40 HC

### General characteristics

- Especially designed for maintaining and serving previously prepared cold food. Ideal to replace cold chambers or refrigeration units.
- Refrigeration unit with fan built inside the chamber. A constant flow of chilled air is generated by the evaporation fans, leading to a fastest temperature drop, as well as a better, more uniform cool air distribution.
- Digital reading electronic to monitor and control chamber temperature and defrosting cycle.
- Operating temperature ranges from +2 °C to +8 °C with a 32 °C room temperature.
- Doubled wall with an injected CFC-free, ecological polyurethane.
- 40 kg/m<sup>3</sup> density isolation. With its highly-insulated walls, heat transfers are reduced thus obtaining energy savings.
- Automatic locking mechanism in hinges: when door is in a position of less than a 90° angle it gets fully closed, thus avoiding rising of temperature.
- Four (4) sound-proof castors of 125 mm diameter, two of them with brakes for an easy handling and safer use. Non-marking, special rubber bumpers to protect against direct impacts in all four (4) corners.
- Key locked door.
- Made of stainless steel.
- GN 2/1 shelves supplied as standard depending on model.
- Operating voltage and frequency: 230 V - 1+N 50 Hz.

MODEL	GAS	HZ	CODE	DIMENSIONS (mm)	DOORS	LEVELS GN-2/1 (SEPARATION 60mm)	POWER (W)	CLIMATE CLASS	COLD GROUP	€
 ECFF-20 HC	R-290	50	19075905	826x866x1875	1	17	249	4	Included	-
 ECFF-40 HC	R-290	50	19075112	1516x864x1775	2	40	332	4	Included	-







Static  
preparation



# Sinks, hand basins, professional faucets

Sinks.....	428
— 500 Range.....	429
— 600 Range.....	431
— 700 Range.....	433
— Large capacity.....	435
— With sorting hole.....	436
— Food processing.....	437
— Pot wash.....	437
— Accessories.....	438
— Options.....	439
Wall and floor type hand basins...	440
Professional faucets.....	441
— Shower units.....	441
— Manual faucets.....	444
— Sensor faucets.....	445
— Hose reels.....	445
— Accessories.....	446



Wash, prep and clean with quality and ergonomics.



Access the website

# 500 Range



SK-510 WD B1 D1R



See options

## Sinks

- Worktop made from AISI-304 18/10 stainless steel with satin finish, 0.8 mm thickness and overflow rim.
- 500 mm width worktop, with integral backsplash of 30 mm and 30 mm front edge.
- Single-pressed, sound-proof bowl.
- Drain valve and overflow pipe for each bowl.

## Sink with legs

- Frame entirely built in stainless steel to ensure maximum durability.
- Square section stainless steel legs 30x30 mm.
- 850 mm height with stainless steel height-adjustable feet (-10 mm / + 50 mm).
- **Supplied assembled.**



MODEL	DIMENSIONS (mm)	BOWL DIMENSION (mm)	SINK			SINK WITH LEGS		
			T	€	L	€		
SK-510	1000x500	B1 D1R	340x365x150	19092980	-	19092984	-	
			340x365x150	19092981	-	19092985	-	
SK-513	1350x500	B2 D1R	340x365x150	19092982	-	19092986	-	
			340x365x150	19092983	-	19092987	-	

## Sink cabinet with door for undercounter dishwasher



- Designed to add a dishwasher.
- Frame entirely built in stainless steel to ensure maximum durability.
- Lower base reinforced with profile to guarantee greater robustness.
- Square section stainless steel legs 30x30 mm.
- 850 mm height with stainless steel height-adjustable feet (-10 mm / + 50 mm).
- Open back for access to the facilities.
- **Supplied assembled (except sink).**
- **Option door lock.**

MODEL	DIMENSIONS (mm)	BOWL DIMENSION (mm)	SINK CABINETS WITH DOOR		€
			WD	€	
SK-510	1000x500	B1 D1R	340x365x150	19092988	-
			340x365x150	19092989	-
SK-513	1350x500	B2 D1R	340x365x150	19092990	-
			340x365x150	19092991	-

## Accessories

### Wall brackets for 500 Range sinks

- Made from stainless steel.
- Compatible with 500 Range sinks.
- Set of two (2) brackets (left + right).



MODEL	CODE	€
S-5	19092487	-





# 600 Range



SK-620 S B2 D2RL



See options

## Sinks

- Worktop made from AISI-304 18/10 stainless steel with satin finish, 1 mm thickness and overflow rim.
- 600 mm width worktop, with integral backsplash of 100 x 15 mm thick, 50 mm front edge with welded corners.

- Single-pressed, sound-proof bowl.
- Drain valve and overflow pipe for each bowl.

## Sinks with legs

- Designed to add a lower shelf (accessory).
- Frame entirely built in stainless steel to ensure maximum durability.
- Square section stainless steel legs 40x40 mm.
- Rear legs set back 40 mm for floors with sanitary radius.

- 850 mm height with stainless steel height-adjustable feet (-10 mm / + 50 mm).
- **Supplied disassembled.**
- **Option shipped assembled.**



MODEL	DIMENSIONS (mm)	BOWL DIMENSIONS (mm)	SINK	€	SINK WITH LEGS	€	SINK WITH LEGS AND SHELF	€
			T		T		T	
SK-66	600x600	B1	500x400x250	19092992	-	19093008	-	19093024
SK-610	1000x600	B1 D1R	400x400x250	19092993	-	19093009	-	19093025
		B1 D1L	400x400x250	19092994	-	19093010	-	19093026
		B2	400x400x250	19092995	-	19093011	-	19093027
SK-612	1200x600	B1 D1R	500x400x250	19092996	-	19093012	-	19093028
		B1 D1L	500x400x250	19092997	-	19093013	-	19093029
		B2	500x400x250	19092998	-	19093014	-	19093030
SK-614	1400x600	B2 D1R	400x400x250	19092999	-	19093015	-	19093031
		B2 D1L	400x400x250	19093000	-	19093016	-	19093032
		B1 D1R	500x400x250	19093001	-	19093017	-	19093033
		B1 D1L	500x400x250	19093002	-	19093018	-	19093034
SK-616	1600x600	B2 D1R	500x400x250	19093003	-	19093019	-	19093035
		B2 D1L	500x400x250	19093004	-	19093020	-	19093036
SK-618	1800x600	B2 D1R	500x400x250	19093005	-	19093021	-	19093037
		B2 D1L	500x400x250	19093006	-	19093022	-	19093038
SK-620	2000x600	B2 D2RL	500x400x250	19093007	-	19093023	-	19093039

## Sink cabinets with doors

- Frame entirely built in stainless steel to ensure maximum durability.
- Lower base reinforced with profile to guarantee greater robustness.
- Square section stainless steel legs 40x40 mm.
- Rear legs set back 40 mm for floors with sanitary radius.
- Open back for access to the facilities.

- 850 mm height with stainless steel heightadjustable feet (-10 mm / + 50 mm).
- **Supplied assembled.**
- **Option door lock..**



MODEL	DIMENSIONS (mm)	BOWL DIMENSIONS (mm)	SINK CABINETS WITH DOOR	DOOR TYPE	€
			D		
SK-66	600x600	B1	500x400x250	19093040	Swing
SK-610	1000x600	B1 D1R	400x400x250	19093041	Sliding
		B1 D1L	400x400x250	19093042	Sliding
		B2	400x400x250	19093043	Sliding
SK-612	1200x600	B1 D1R	500x400x250	19093044	Sliding
		B1 D1L	500x400x250	19093045	Sliding
		B2	500x400x250	19093046	Sliding
SK-614	1400x600	B2 D1R	400x400x250	19093047	Sliding
		B2 D1L	400x400x250	19093048	Sliding
		B1 D1R	500x400x250	19093049	Sliding
		B1 D1L	500x400x250	19093050	Sliding
SK-616	1600x600	B2 D1R	500x400x250	19093051	Sliding
		B2 D1L	500x400x250	19093052	Sliding
SK-618	1800x600	B2 D1R	500x400x250	19093053	Sliding
		B2 D1L	500x400x250	19093054	Sliding
SK-620	2000x600	B2 D2RL	500x400x250	19093055	Sliding

## Sink cabinet with door for undercounter dishwasher

- Designed to add a dishwasher and a lower shelf (accessory).
- Frame entirely built in stainless steel to ensure maximum durability.
- Square section stainless steel legs 40x40 mm.
- Rear legs set back 40 mm for floors with sanitary radius.

- 850 mm height with stainless steel heightadjustable feet (-10 mm / + 50 mm).
- Supplied disassembled.
- **Models with doors are supplied assembled (except sinks).**
- **Option shipped assembled.**
- **Option door lock.**



MODEL	DIMENSIONS (mm)	BOWL DIMENSIONS (mm)	SINK WITH LEGS	€	SINK WITH LEGS AND SHELF	€	SINK CABINETS WITH DOOR	DOOR TYPE	€
			WL		WS		WD		
SK-612	1200x600	B1 D1R	500x400x250	19093056	-	19093062	-	19093068	Swing
		B1 D1L	400x400x250	19093057	-	19093063	-	19093069	Swing
SK-614	1400x600	B1 D1R	400x400x250	19093058	-	19093064	-	19093070	Swing
		B1 D1L	400x400x250	19093059	-	19093065	-	19093071	Swing
SK-618	1800x600	B1 D1R	500x400x250	19093060	-	19093066	-	19093072	Sliding
		B1 D1L	500x400x250	19093061	-	19093067	-	19093073	Sliding

# 700 Range



SK-716 S B2 D1L



See options

## Sinks

- Worktop made from AISI-304 18/10 stainless steel with satin finish, 1 mm thickness and overflow rim.
- 700 mm width worktop, with integral backsplash of 100 x 15 mm thick, 50 mm front edge with welded corners.

- Single-pressed, sound-proof bowl.
- Drain valve and overflow pipe for each bowl.

## Sinks with legs

- Designed to add a lower shelf (accessory).
- Frame entirely built in stainless steel to ensure maximum durability.
- Square section stainless steel legs 40x40 mm.
- Rear legs set back 40 mm for floors with sanitary radius.

- 850 mm height with stainless steel height-adjustable feet (-10 mm / + 50 mm).
- **Supplied disassembled.**
- **Option shipped assembled.**



MODEL	DIMENSIONS (mm)	BOWL DIMENSIONS (mm)	SINK	€	SINK WITH LEGS		SINK WITH LEGS AND SHELF		
					T	L	S	€	
SK-77	700x700	B1	500x500x300	19093074	-	19093092	-	19093110	-
SK-710	1000x700	B1 D1R	400x500x300	19093075	-	19093093	-	19093111	-
		B1 D1L	400x500x300	19093076	-	19093094	-	19093112	-
		B2	400x500x300	19093077	-	19093095	-	19093113	-
SK-712	1200x700	B1 D1R	500x500x300	19093078	-	19093096	-	19093114	-
		B1 D1L	500x500x300	19093079	-	19093097	-	19093115	-
		B2	500x500x300	19093080	-	19093098	-	19093116	-
SK-714	1400x700	B1 D1R	600x500x300	19093081	-	19093099	-	19093117	-
		B1 D1L	600x500x300	19093082	-	19093100	-	19093118	-
		B2	600x500x300	19093083	-	19093101	-	19093119	-
SK-716	1600x700	B2 D1R	500x500x300	19093084	-	19093102	-	19093120	-
		B2 D1L	500x500x300	19093085	-	19093103	-	19093121	-
SK-718	1800x700	B2 D1R	500x500x300	19093086	-	19093104	-	19093122	-
		B2 D1L	500x500x300	19093087	-	19093105	-	19093123	-
		B3	500x500x300	19093088	-	19093106	-	19093124	-
SK-720	2000x700	B2 D1R	600x500x300	19093089	-	19093107	-	19093125	-
		B2 D1L	600x500x300	19093090	-	19093108	-	19093126	-

## Sink cabinets with doors

- Frame entirely built in stainless steel to ensure maximum durability.
- Lower base reinforced with profile to guarantee greater robustness.
- Square section stainless steel legs 40x40 mm.
- Rear legs set back 40 mm for floors with sanitary radius.

- Open back for access to the facilities.
- 850 mm height with stainless steel height-adjustable feet (-10 mm / + 50 mm).
- **Supplied assembled.**
- **Option door lock.**



MODEL	DIMENSIONS (mm)	BOWL DIMENSIONS (mm)	SINK CABINETS WITH DOOR		DOOR TYPE	€
			D	D		
SK-77	700x700	B1	500x500x300	19093128	Swing	-
SK-710	1000x700	B1 D1R	400x500x300	19093129	Sliding	-
		B1 D1L	400x500x300	19093130	Sliding	-
		B2	400x500x300	19093131	Sliding	-
SK-712	1200x700	B1 D1R	500x500x300	19093132	Sliding	-
		B1 D1L	500x500x300	19093133	Sliding	-
		B2	500x500x300	19093134	Sliding	-
SK-714	1400x700	B1 D1R	600x500x300	19093135	Sliding	-
		B1 D1L	600x500x300	19093136	Sliding	-
		B2	600x500x300	19093137	Sliding	-
SK-716	1600x700	B2 D1R	500x500x300	19093138	Sliding	-
		B2 D1L	500x500x300	19093139	Sliding	-
SK-718	1800x700	B2 D1R	500x500x300	19093140	Sliding	-
		B2 D1L	500x500x300	19093141	Sliding	-
		B3	500x500x300	19093142	Sliding	-
SK-720	2000x700	B2 D1R	600x500x300	19093143	Sliding	-
		B2 D1L	600x500x300	19093144	Sliding	-

## Sink cabinet with door for undercounter dishwasher

- Designed to add a dishwasher and a lower shelf (accessory).
- Frame entirely built in stainless steel to ensure maximum durability.
- Square section stainless steel legs 40x40 mm.
- Rear legs set back 40 mm for floors with sanitary radius.

- 850 mm height with stainless steel height-adjustable feet (-10 mm / + 50 mm).
- Supplied disassembled.
- Models with doors are supplied assembled (except sinks).
- **Option shipped assembled.**
- **Option door lock.**



MODEL	DIMENSIONS (mm)	BOWL DIMENSIONS (mm)	SINK WITH LEGS		SINK WITH LEGS AND SHELF		SINK CABINETS WITH DOOR	DOOR TYPE	€	
			WL	€	WS	€				
SK-712	1200x700	B1 D1R	500x500x300	19093145	-	19093151	-	19093157	Swing	-
		B1 D1L	500x500x300	19093146	-	19093152	-	19093158	Swing	-
SK-714	1400x700	B1 D1R	600x500x300	19093147	-	19093153	-	19093159	Swing	-
		B1 D1L	600x500x300	19093148	-	19093154	-	19093160	Swing	-
SK-718	1800x700	B2 D1R	500x500x300	19093149	-	19093155	-	19093161	Sliding	-
		B2 D1L	500x500x300	19093150	-	19093156	-	19093162	Sliding	-

## Large capacity



SKBB-714 L B1



See options

### Sinks

- Worktop made from AISI-304 18/10 stainless steel with satin finish, 1 mm thickness and overflow rim.
- 700 mm width worktop, with integral backsplash of 100 x 15 mm thick, 50 mm front edge with welded corners.
- Single-pressed, sound-proof bowl.
- Drain valve and overflow pipe for each bowl.

### Sinks with legs

- Designed to add a lower shelf (accessory).
- Frame entirely built in stainless steel to ensure maximum durability.
- Square section stainless steel legs
- 40x40 mm.
- Rear legs set back 40 mm for floors with sanitary radius.
- 850 mm height with stainless steel height-

### Sink cabinets with doors

- Frame entirely built in stainless steel to ensure maximum durability.
- Lower base reinforced with profile to guarantee greater robustness.
- Square section stainless steel legs
- 40x40 mm.
- Rear legs set back 40 mm for floors with sanitary radius.
- Open back for access to the facilities.
- 850 mm height with stainless steel height-adjustable feet (-10 mm / + 50 mm).
- **Supplied assembled.**
- **Option door lock.**

MODEL	DIMENSIONS (mm)	BOWL DIMENSIONS (mm)	SINK		€	SINK WITH LEGS		€	WITH LEGS AND SHELF		€	SINK CABINETS WITH DOOR		€
			T	L		L	S		D					
SKBB-710	1000x700	B1	800x500x400	19093163	-	19093169	-	19093175	-	19093181	-			
SKBB-712	1200x700	B1	955x510x380	19093164	-	19093170	-	19093176	-	19093182	-			
SKBB-714	1400x700	B1	1280x510x380	19093165	-	19093171	-	19093177	-	19093183	-			
SKBB-716	1600x700	B1 D1R	1280x510x380	19093166	-	19093172	-	19093178	-	19093184	-			
SKBB-718	1800x700	B2	800x500x400	19093167	-	19093173	-	19093179	-	19093185	-			

### Accessories

#### Sliding drainer

- Specially designed to be installed on large capacity sinks to facilitate drainage.
- Made from stainless steel.

MODEL	CODE	DIMENSIONS (mm)	€
SG-35	19092488	400x500	-



## With sorting hole



SK-614 L B1 S1L



See options

### Sinks

- Worktop made from AISI-304 18/10 stainless steel with satin finish, 1 mm thickness and overflow rim.
- Worktop with backsplash of 100 x 15 mm thick, 50 mm front edge with welded corners.
- Single-pressed, sound-proof bowl.
- Drain valve and overflow pipe for each bowl.
- Sorting hole to throw waste into. A waste bin (not included) could be placed under the counter.

### Sinks with legs

- Designed to add a lower shelf (accessory).
- Frame entirely built in stainless steel to ensure maximum durability.
- Square section stainless steel legs
- 40x40 mm.
- Rear legs set back 40 mm for floors with sanitary radius.
- 850 mm height with stainless steel height-
- adjustable feet (-10 mm / + 50 mm).
- **Supplied disassembled.**
- **Option shipped assembled.**

### 600 Range

MODEL	DIMENSIONS (mm)	BOWL DIMENSIONS (mm)	SINK		€	SINK WITH LEGS		-€	WITH LEGS FOR UNDERCOUNTER DISHWASHER		€
			T	L		L	WL				
SK-614	1400x600	B1 S1L	500x400x250	19093187	-	19093191	-	-	-	-	
			500x400x250	19093188	-	19093192	-	-	-		
SK-618	1800x600	B1 D1R S1L	500x400x250	19093189	-	19093193	-	-	19093195	-	
			500x400x250	19093190	-	19093194	-	-	19093196	-	

### 700 Range

MODEL	DIMENSIONS (mm)	BOWL DIMENSIONS (mm)	SINK		€	SINK WITH LEGS		€	WITH LEGS FOR UNDERCOUNTER DISHWASHER		€
			T	L		L	WL				
SK-714	1400x700	B1 S1L	500x500x300	19093197	-	19093201	-	-	-	-	
			500x500x300	19093198	-	19093202	-	-	-		
SK-718	1800x700	B1 D1R S1L	500x500x300	19093199	-	19093203	-	-	19093205	-	
			500x500x300	19093200	-	19093204	-	-	19093206	-	

## Food processing



SKMFP-714 L



### Sinks

- Worktop made from AISI-304 18/10 stainless steel with satin finish, 1 mm thickness and overflow rim, specially designed to clean fresh food.
- 700 mm width worktop, with integral backsplash of 100 x 15 mm thick, 50 mm front edge with welded corners.
- Sorting hole to throw waste into. A waste bin (not included) could be placed under the counter.
- SKVEP model: overflow pipe, 2" drain hole and a sound-proof large capacity bowl with the possibility of superimposing GN 1/3, 1/2, 1/1, 2/3 pans. 20 mm thick polyethylene cutting board.
- SKMFP model: perforated tray for draining or defrosting, with recess in diamond point finish and centered drain. 20 mm thick polythene cutting board.

### Sinks with legs

- Designed to add a lower shelf (accessory).
- Frame entirely built in stainless steel to ensure maximum durability.
- Square section stainless steel legs 40x40 mm.
- Rear legs set back 40 mm for floors with sanitary radius.

- 850 mm height with stainless steel height-adjustable feet (-10 mm / + 50 mm).

- **Supplied disassembled.**
- **Option shipped assembled.**



### 700 Range

DESCRIPTION	DIMENSIONS (mm)	BOWL DIMENSIONS (mm)	MODEL	SINK	€	MODEL	SINK WITH LEGS	€
Vegetable preparation table	1400x700	1140x320x170	SKVEP-714 T	19093207	-	SKVEP-714 L	19093209	-
Meat and fish preparation table	1400x700	1140x320x30	SKMFP-714 T	19093208	-	SKMFP-714 L	19093210	-

## Pot wash



SKDU-66 F

- Worktop made from AISI-304 18/10 stainless steel with satin finish, 1 mm thickness and overflow rim, specially designed to fill and empty large pots.
- Worktop with backsplash of 100 x 15 mm thick, 50 mm front edge with welded corners.
- Single-pressed, sound-proof bowl.
- Drain valve and overflow pipe for each bowl.
- Removable grid to support large pots, included.
- Frame entirely built in stainless steel to ensure maximum durability.
- Square section stainless steel legs 40 x 40 mm.
- Rear legs set back 40 mm for floors with sanitary radius.
- 555 mm height with stainless steel height-adjustable feet (-10 mm / + 50 mm).
- **Supplied assembled.**

DIMENSIONS (mm)	BOWL DIMENSIONS (mm)	MODEL	CODE	€
600x600x555	500x400x250	SKDU-66 F	19093211	-
700x700x555	500x500x300	SKDU-77 F	19093212	-

## Accessories

### Detached side splash

- Specially designed to be assembled easily on any sink.
- Made from AISI-304 18/10 stainless steel.



RANGE	MODEL	CODE	SIDE	€
600	TPB-6 R	19092813	Right	-
	TPB-6 L	19092814	Left	-
700	TPB-7 R	19092815	Right	-
	TPB-7 L	19092816	Left	-

### Perforated bottom

- Specially designed to be assembled at the bottom of the bowls to facilitate the cleaning of food.
- Made from AISI-304 18/10 stainless steel.



BOWL DIMENSIONS (mm)	HOLE POSITION	MODEL	CODE	€
400x400	Right/Left	SKFPB-44	19092977	-
500x400	Right	SKFPB-54 R	19092780	-
	Left	SKFPB-54 L	19092489	-
500x500	Right/Left	SKFPB-55	19092782	-
600x500	Right	SKFPB-65 R	19092784	-
	Left	SKFPB-65 L	19092783	-

### Shelves

- Made from AISI-304 18/10 stainless steel with satin finish.
- Lower base reinforced with profile to guarantee greater robustness.
- Assembly by fixing four (4) screws.



DIMENSIONS (mm)	MODEL	600 RANGE	€	MODEL	700 RANGE	€
<b>FOR SINKS WITH LEGS</b>						
600	NS-66	19094220	-	-	-	-
700	-	-	-	NS-77	19094240	-
1000	NS-610	19094224	-	NS-710	19094243	-
1200	NS-612	19094226	-	NS-712	19094245	-
1400	NS-614	19094228	-	NS-714	19094247	-
1600	NS-616	19094230	-	NS-716	19094249	-
1800	NS-618	19094232	-	NS-718	19094251	-
2000	NS-620	19094234	-	NS-720	19094253	-
<b>FOR SINKS WITH LEGS AND UNDERCOUNTER DISHWASHER</b>						
1200	NS-66	19094220	-	NS-76	19094206	-
1400	NS-66	19094220	-	NS-77	19094240	-
1800	NS-612	19094226	-	NS-712	19094245	-

### Wall brackets

- Made from stainless steel.
- Compatible with worktops and 600/700 range sinks, except 600 x 600 mm and pot wash sinks.
- Price for a unit.



DESCRIPTION	MODEL	CODE	€ / Unid
Wall bracket	C-6	19092785	-
Bracket with leg	CP-6	19092786	-

### Sorting hole lid

- Specially designed to be placed on the sorting hole to cover it.



MODEL	CODE	€
RL-232	19092820	-



## Options

Option shipped assembled.

ABBREVIATION	CODE	DIMENSIONS (mm)	€
A	0201-0001	Up to 1200 mm	-
A	0201-0002	Up to 2000 mm	-
A	0201-0003	Up to 2800 mm	-

Option element height.

ABBREVIATION	CODE	DIMENSIONS (mm)	€
H9	0202-0001	900 mm (-10/+50)	-





Option stainless steel reinforcements with profile.

ABBREVIATION ONE (1) SHELF	CODE	DIMENSIONS (mm)	€
SS	0205-0006	Up to 1200 mm	-
SS	0205-0007	Up to 1600 mm	-
SS	0205-0008	Up to 2000 mm	-

Option door lock.

ABBREVIATION	CODE	DESCRIPTION	€
CR	0206-0001	One (1) lock	-

Option faucet hole Ø 33 mm.

ABBREVIATION	CODE	DESCRIPTION	€
33R1	0208-0001	 One (1) hole to the right	-
33L1	0208-0002	 One (1) hole to the left	-
33C1	0208-0003	 One (1) hole centered	-
33B1	0208-0004	 One (1) hole between two (2) bowls	-
33R2	0208-0005	 Two (2) holes to the right	-
33L2	0208-0006	 Two (2) holes to the left	-
33C2	0208-0007	 Two (2) holes centered	-
33B2	0208-0008	 Two (2) holes between three (3) bowls	-
33R3	0208-0009	 Three (3) holes to the right	-
33L3	0208-0010	 Three (3) holes to the left	-
33C3	0208-0011	 Three (3) holes centered	-

Note: For sinks with legs and undercounter dishwasher, the hole cannot be located between the drainer and the bowl.

## Wall and floor type hand basins



HWW-44



HWF-44

- Entirely made from stainless steel.
- Deep drawn bowl with fully welded corners.
- Supplied fully equipped, ready to install.

- Include as standard equipment:
  - Mixer and taps to regulate the flow of hot and cold water.
  - 1/2" flexible tubes for high pressure water.
  - Drain valve.

- In floor type: front door.

Rotating spout

- Easy-to-operate push button and rotating spout.

MODEL	CODE	DIMENSIONS (mm)	BOWL DIMENSIONS (mm)	SOAP DISPENSER	NUMBER OF PUSHBUTTONS	€
WALL TYPE HAND BASINS						
HWW-33	19092821	350x315x173	Ø 225x105	No	-	-
HWW-44	19092822	400x400x173	Ø 360x130	No	-	-
HWW-44-D	19092823	400x400x173	Ø 360x130	Yes	-	-
FLOOR TYPE HAND BASINS						
HWF-44	19092826	400x440x850	Ø 360x130	No	1	-
HWF-44-D	19092827	400x440x850	Ø 360x130	Yes	1	-

Electronic tap

- Electronic tap with electrical connection 230V 1N 50/60 Hz.

MODEL	CODE	DIMENSIONS (mm)	BOWL DIMENSIONS (mm)	SOAP DISPENSER	€
WALL TYPE HAND BASINS					
HWW-44-E	19092824	400x400x173	Ø 360x130	No	-
HWW-44-E-D	19092825	400x400x173	Ø 360x130	Yes	-
FLOOR TYPE HAND BASINS					
HWF-44-E	19092828	400x440x850	Ø 360x130	No	-
HWF-44-E-D	19092829	400x440x850	Ø 360x130	Yes	-

# Shower units

## 1200 mm height

- High-quality, durable and ergonomic shower unit. Designed for intensive use in professional kitchens.
- Polished chrome plated brass body, with steel spring hose and flexible tube with protective coating in transparent

- plastic resistant to high temperature and water pressure.
- Support column in AISI-304 18/10 stainless steel, for lasting protection against corrosion.
- Ergonomic shower with anti-heat plastic

- handle, flow regulation, with clip ring for continuous use and non-return valve.
- Connecting tubes and all needed accessories for installation included.

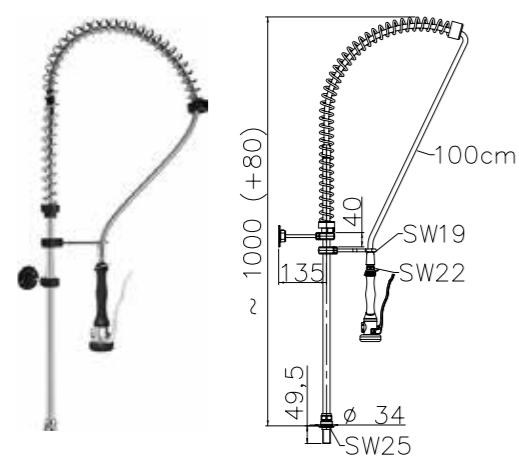

MODEL	CODE	DESCRIPTION	€
FPD-11	19095041	Direct water shower unit	-

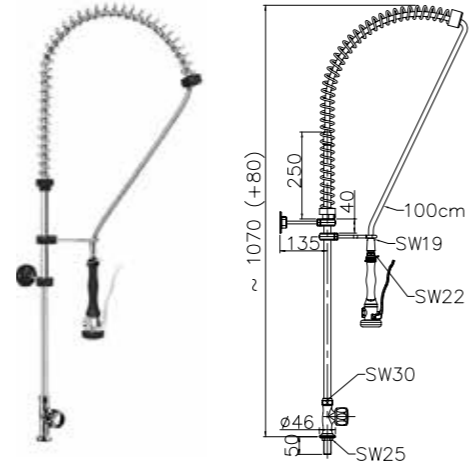

MODEL	CODE	DESCRIPTION	€
FPTH-11	19095042	One-hole connection shower unit	-

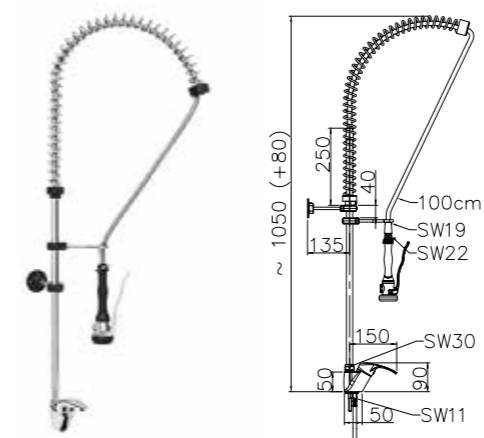

MODEL	CODE	DESCRIPTION	€
FPSL-21	19095045	Two-hole shower unit with single lever	-

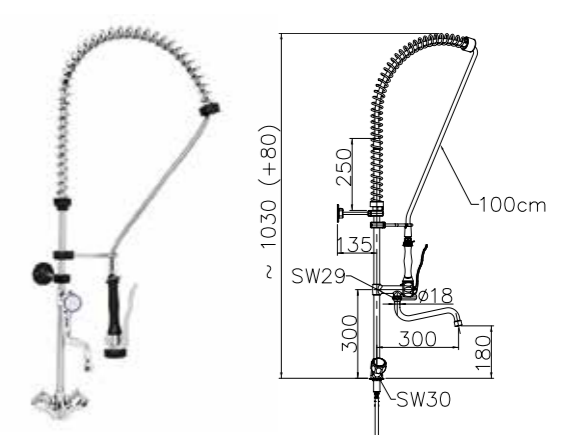

MODEL	CODE	DESCRIPTION	€
FPTH-21-MS	19095046	Two-hole shower unit with faucet	-

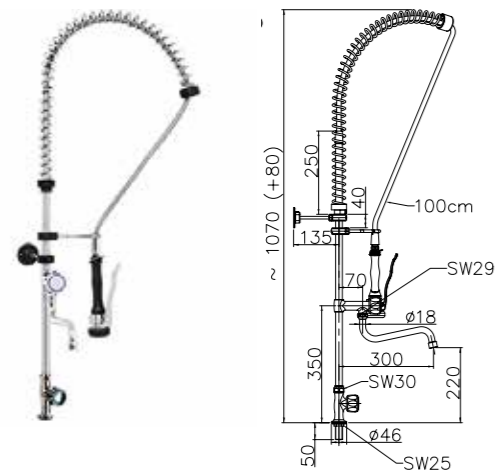

MODEL	CODE	DESCRIPTION	€
FPTH-11-MS	19095043	One-hole shower unit with faucet	-

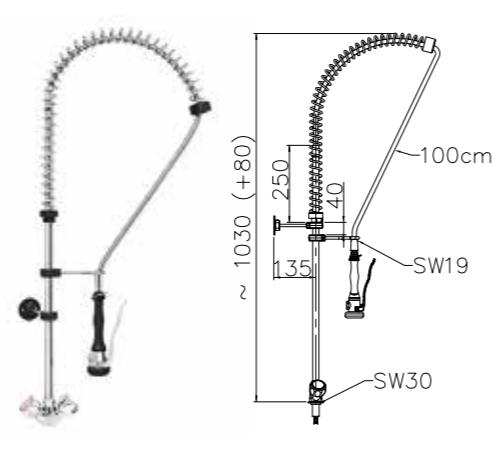

MODEL	CODE	DESCRIPTION	€
FPTH-21	19095044	Two-hole connection shower unit	-

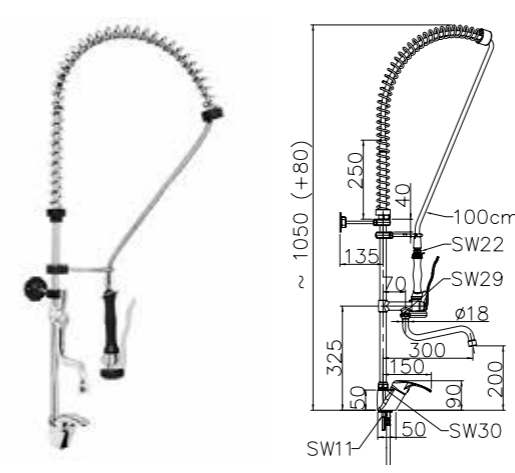

MODEL	CODE	DESCRIPTION	€
FPCL-21-MS	19095047	Two-hole shower unit with single lever and faucet	-

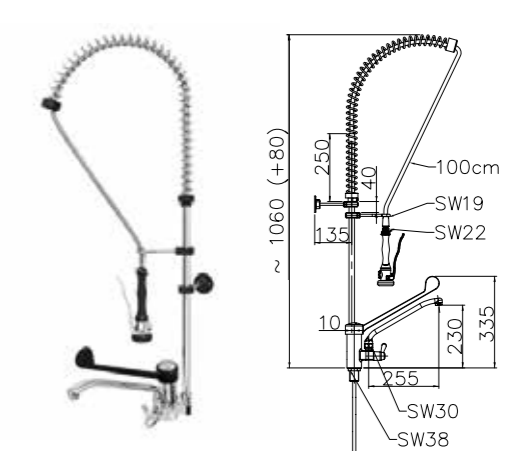

MODEL	CODE	DESCRIPTION	€
FPCL-21	19095048	Gerontological shower unit with faucet	-

1200 mm height

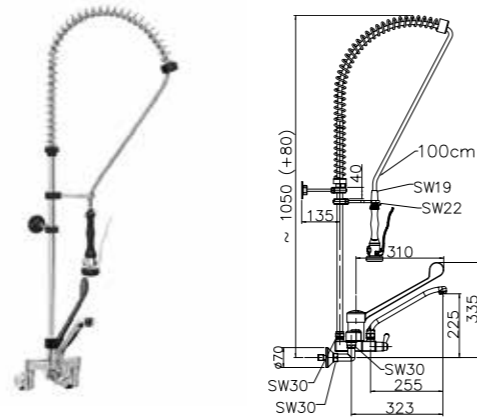
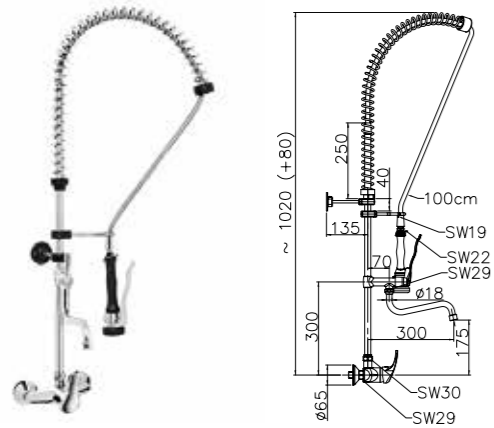

MODEL	CODE	DESCRIPTION	€
FPSL-22W-MS	19095049	Wall-mounted shower unit with faucet	-

MODEL	CODE	DESCRIPTION	€
FPCL-22W	19095060	Gerontological wall-mounted shower unit	-

600 mm height

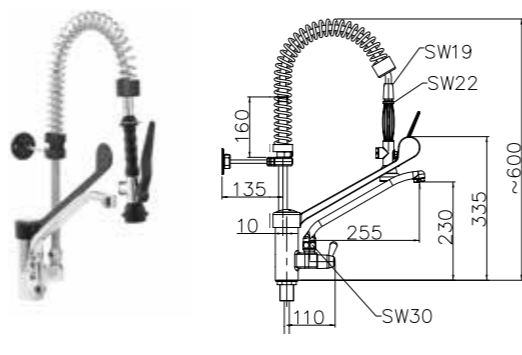
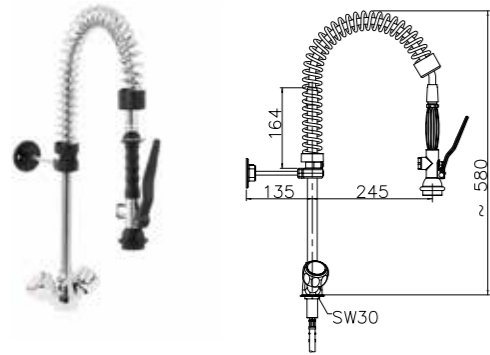

MODEL	CODE	DESCRIPTION	€
FP6TH-21	19095061	Two-hole shower unit height 600 mm	-

MODEL	CODE	DESCRIPTION	€
FP6CL-21	19095062	Two-hole gerontological shower unit height 600 mm	-

# Manual faucets

- High-quality manual faucet. Designed for intensive use in professional kitchens.  
- Polished chrome plated brass body.

- Handle ergonomic design makes easier water flow opening, regulating and closing operations.

- Connecting tubes and all needed accessories for installation included.

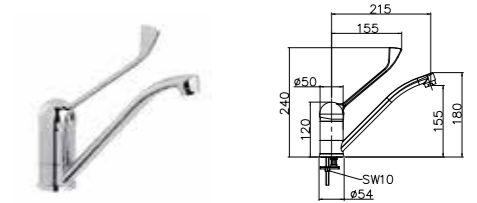
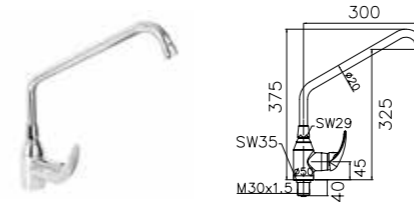

MODEL	CODE	DESCRIPTION	€
FMSL-123	19095063	Single lever mixer faucet with high swivel nozzle	-

MODEL	CODE	DESCRIPTION	€
FMCL-112	19095064	High single lever mixer faucet with low swivel nozzle	-

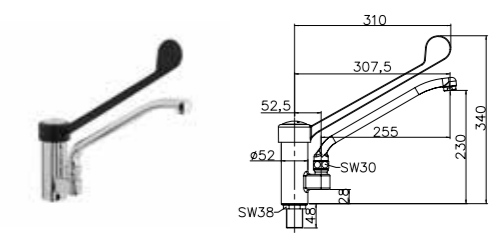
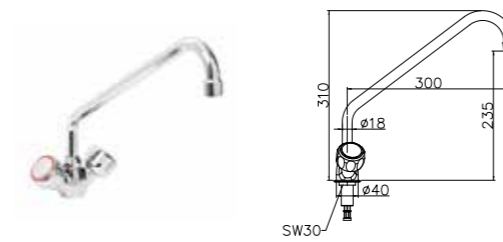

MODEL	CODE	DESCRIPTION	€
FMTH-123	19095065	Mixer faucet with knobs	-

MODEL	CODE	DESCRIPTION	€
FMCL-123	19095066	Gerontological mixer faucet	-

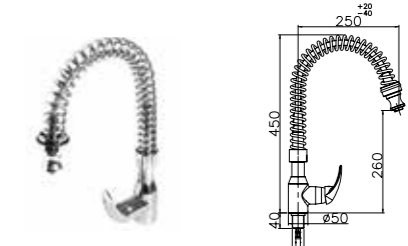
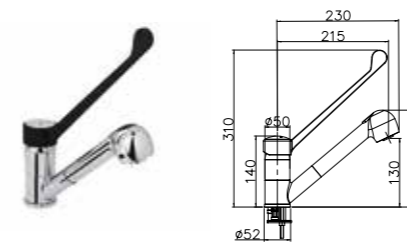

MODEL	CODE	DESCRIPTION	€
FMCL-112R	19095067	Single lever mixer faucet with removable swivel nozzle	-

MODEL	CODE	DESCRIPTION	€
FSMSL-122	19095068	Single lever mixer faucet with springs	-

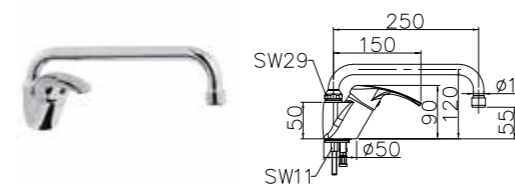

MODEL	CODE	DESCRIPTION	€
FMSL-112	19095070	Single lever mixer faucet with low swivel nozzle	-

## Sensor faucets

- Electronic faucet with infrared sensors for opening and closing water flow automatically. Designed for intensive use in professional kitchens.

- Complete hygiene and greater usability, without pedals or buttons.  
 - Polished chrome plated brass body.  
 - Automatic closing of solenoid valve in the

event of a power failure or dead battery.  
 - Connecting tubes and all needed accessories for installation included.  
 - Mixing valve not included.



MODEL	CODE	DESCRIPTION	€
FE-121	19095073	Electronic faucet with high nozzle mains-operated	-

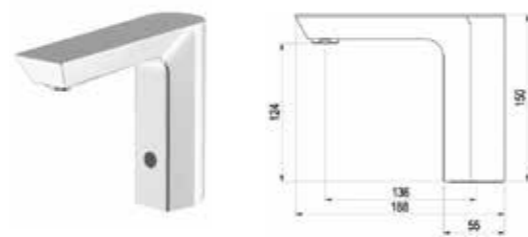

MODEL	CODE	DESCRIPTION	€
FE-111	19095074	Electronic faucet mains-operated	-
FE-111 B	19095075	Electronic faucet battery-operated	-

## Hose reels

- Hose reel designed for intensive use in food service, meat or fish processing operations, etc.

304 18/10 stainless steel.

- Retractable food grade hose resistant to temperature.

- Hose with locking system allowing to maintain the desired length without effort.  
 - Wall-mounted configuration.

- Structure and support made entirely of AISI



MODEL	CODE	HOSE LENGTH (m)	€
WOR-10	19101240	10	-
WOR-15	19101242	15	-

## Accessories

### Foot-operated faucet

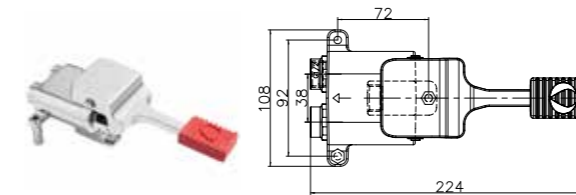

MODEL	CODE	DESCRIPTION	€
FM-1	19095076	Foot-operated two-hole faucet, single	-

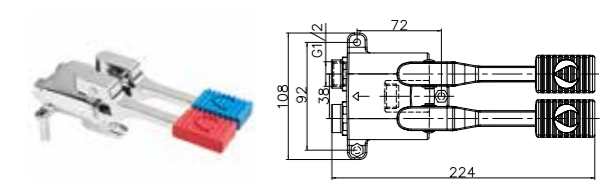

MODEL	CODE	DESCRIPTION	€
FM-2	19095077	Foot-operated two-hole faucet, double	-

### Other accessories

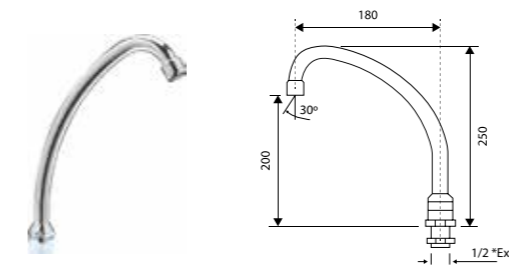

MODEL	CODE	DESCRIPTION	€
FM-111	19095078	High nozzle swing faucet	-



MODEL	CODE	DESCRIPTION	€
FPS-100	19095082	Flexible stainless steel hose with plastic coating resistant to high pressures and temperatures. 1000 mm length. 1/2\"/>	

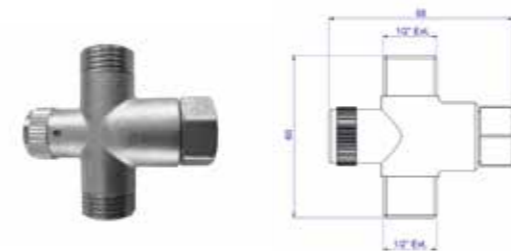

MODEL	CODE	DESCRIPTION	€
MV	19095552	Mixing valve with regulator and back-flow preventer	-



# Work tables and cabinets

Work tables .....	447
— Wall-mounted tables .....	449
— Central tables.....	451
— Wall-mounted tables with bowl.....	453
— Work tables 600 mm high .....	455
— Worktops .....	457
— Wall-mounted tables with drawers.....	459
— Corner tables .....	459
— Waste collection tables.....	460
— Recycling tables .....	460
— Countertop shelves .....	461
— Accessories .....	462
— Options .....	465
Cabinets.....	466
— Wall-mounted cabinets.....	466
— High cabinets.....	467



Making kitchen daily work easier.



Access the website

# Wall-mounted tables

 Option customization in length



TWDDR3R-614



See options

- Worktop made from AISI-304 18/10 stainless steel with satin finish and reinforced with profiles.
- Backsplash of 100 x 15 mm, 50 mm front edge with welded corners.
- Square section stainless steel legs 40 x 40 mm.
- Rear legs set back 40 mm for floors with sanitary radius.

- 850 mm height with stainless steel height-adjustable feet (-10 mm / + 50 mm).
- **Supplied disassembled (except models with doors).**
- **Option shipped assembled.**
- **Option door lock.**

## 500 Range



DIMENSIONS (mm)	WITH REINFORCEMENT FRAME		WITH ONE (1) SHELF		WITH TWO (2) SHELVES		WITH DOORS	
	TWLR-5	€	TWS1-5	€	TWS2-5	€	TWD-5	DOOR TYPE
600x500x850	19093246	-	19093257	-	19093268	-	-	-
800x500x850	19093247	-	19093258	-	19093269	-	19093279	Swing
1000x500x850	19093248	-	19093259	-	19093270	-	19093280	Sliding
1200x500x850	19093249	-	19093260	-	19093271	-	19093281	Sliding
1400x500x850	19093250	-	19093261	-	19093272	-	19093282	Sliding
1500x500x850	19093251	-	19093262	-	19093273	-	-	-
1600x500x850	19093252	-	19093263	-	19093274	-	19093283	Sliding
1800x500x850	19093253	-	19093264	-	19093275	-	19093284	Sliding
2000x500x850	19093254	-	19093265	-	19093276	-	19093285	Sliding
2200x500x850	19093255	-	19093266	-	19093277	-	-	-
2400x500x850	19093256	-	19093267	-	19093278	-	-	-

## 600 Range



DIMENSIONS (mm)	WITH REINFORCEMENT FRAME		WITH ONE (1) SHELF		WITH TWO (2) SHELVES		WITH DOORS		SLIDING DOORS AND DRAWERS		
	TWLR-6	€	TWS1-6	€	TWS2-6	€	TWD-6	DOOR TYPE	€	TO THE RIGHT	TO THE LEFT
	TWDDR3R-6 TWDDR3L-6										
600x600x850	19093364	-	19093383	-	19093402	-	-	-	-	-	-
700x600x850	19093365	-	19093384	-	19093403	-	-	-	-	-	
800x600x850	19093366	-	19093385	-	19093404	-	19093421	Swing	-	-	
900x600x850	19093367	-	19093386	-	19093405	-	-	-	-	-	
1000x600x850	19093368	-	19093387	-	19093406	-	19093422	Sliding	-	-	
1100x600x850	19093369	-	19093388	-	19093407	-	-	-	-	-	
1200x600x850	19093370	-	19093389	-	19093408	-	19093423	Sliding	-	-	
1300x600x850	19093371	-	19093390	-	19093409	-	-	-	-	-	
1400x600x850	19093372	-	19093391	-	19093410	-	19093424	Sliding	-	19093590 19093596	
1500x600x850	19093373	-	19093392	-	19093411	-	-	-	-	-	
1600x600x850	19093374	-	19093393	-	19093412	-	19093425	Sliding	-	19093591 19093597	
1700x600x850	19093375	-	19093394	-	19093413	-	-	-	-	-	
1800x600x850	19093376	-	19093395	-	19093414	-	19093426	Sliding	-	19093592 19093598	
1900x600x850	19093377	-	19093396	-	19093415	-	-	-	-	-	
2000x600x850	19093378	-	19093397	-	19093416	-	19093427	Sliding	-	19093593 19093599	
2200x600x850	19093379	-	19093398	-	19093417	-	19093428	Sliding	-	19093594 19093600	
2400x600x850	19093380	-	19093399	-	19093418	-	19093429	Sliding	-	19093595 19093601	
2600x600x850	19093381	-	19093400	-	19093419	-	19093430	Sliding	-	-	
2800x600x850	19093382	-	19093401	-	19093420	-	19093431	Sliding	-	-	

## 700 Range

DIMENSIONS (mm)	WITH REINFORCEMENT FRAME		WITH ONE (1) SHELF		WITH TWO (2) SHELVES		WITH DOORS		SLIDING DOORS AND DRAWERS		
	TWLR-7	€	TWS1-7	€	TWS2-7	€	TWD-7	DOOR TYPE	€	TO THE RIGHT	TO THE LEFT
	TWDDR3R-7 TWDDR3L-7										
600x700x850	19093510	-	19093529	-	19093548	-	-	-	-	-	
700x700x850	19093511	-	19093530	-	19093549	-	-	-	-		
800x700x850	19093512	-	19093531	-	19093550	-	19093567	Swing	-	-	
900x700x850	19093513	-	19093532	-	19093551	-	-	-	-		
1000x700x850	19093514	-	19093533	-	19093552	-	19093568	Sliding	-	-	
1100x700x850	19093515	-	19093534	-	19093553	-	-	-	-		
1200x700x850	19093516	-	19093535	-	19093554	-	19093569	Sliding	-	-	
1300x700x850	19093517	-	19093536	-	19093555	-	-	-	-		
1400x700x850	19093518	-	19093537	-	19093556	-	19093570	Sliding	-	19093614 19093620	
1500x700x850	19093519	-	19093538	-	19093557	-	-	-	-		
1600x700x850	19093520	-	19093539	-	19093558	-	19093571	Sliding	-	19093615 19093621	
1700x700x850	19093521	-	19093540	-	19093559	-	-	-	-		
1800x700x850	19093522	-	19093541	-	19093560	-	19093572	Sliding	-	19093616 19093622	
1900x700x850	19093523	-	19093542	-	19093561	-	-	-	-		
2000x700x850	19093524	-	19093543	-	19093562	-	19093573	Sliding	-	19093617 19093623	
2200x700x850	19093525	-	19093544	-	19093563	-	19093574	Sliding	-	19093618 19093624	
2400x700x850	19093526	-	19093545	-	19093564	-	19093575	Sliding	-	19093619 19093625	
2600x700x850	19093527	-	19093546	-	19093565	-	19093576	Sliding	-	-	
2800x700x850	19093528	-	19093547	-	19093566	-	19093577	Sliding	-	-	

# Central tables

 Option customization in length



TCDDR3R-614



See options

- Worktop made from AISI-304 18/10 stainless steel with satin finish and reinforced with profiles.
- 50 mm front edge with welded corners.
- Square section stainless steel legs 40 x 40 mm.
- 850 mm height with stainless steel height-adjustable feet (-10 mm / + 50 mm).

- **Supplied disassembled (except models with doors).**
- **Option shipped assembled.**
- **Option door lock.**

## 500 Range



DIMENSIONS (mm)	WITH REINFORCEMENT FRAME	€	WITH ONE (1) SHELF	€	WITH TWO (2) SHELVES	€
	TCLR-5		TCS1-5		TCS2-5	
600x500x850	19093213	-	19093224	-	19093235	-
800x500x850	19093214	-	19093225	-	19093236	-
1000x500x850	19093215	-	19093226	-	19093237	-
1200x500x850	19093216	-	19093227	-	19093238	-
1400x500x850	19093217	-	19093228	-	19093239	-
1500x500x850	19093218	-	19093229	-	19093240	-
1600x500x850	19093219	-	19093230	-	19093241	-
1800x500x850	19093220	-	19093231	-	19093242	-
2000x500x850	19093221	-	19093232	-	19093243	-
2200x500x850	19093222	-	19093233	-	19093244	-
2400x500x850	19093223	-	19093234	-	19093245	-

## 600 Range



DIMENSIONS (mm)	WITH REINFORCEMENT FRAME	€	WITH ONE (1) SHELF	€	WITH TWO (2) SHELVES	€	WITH DOORS	€	PASS-THROUGH DOORS	€	DOOR TYPE	SLIDING DOORS AND DRAWERS		€
	TCLR-6		TCS1-6		TCS2-6		TCD-6		TCDP-6			TO THE RIGHT	TO THE LEFT	
												TCDDR3R-6	TCDDR3L-6	
600x600x850	19093286	-	19093305	-	19093324	-	-	-	-	-	-	-	-	-
700x600x850	19093287	-	19093306	-	19093325	-	-	-	-	-	-	-	-	-
800x600x850	19093288	-	19093307	-	19093326	-	19093343	-	-	-	Swing	-	-	-
900x600x850	19093289	-	19093308	-	19093327	-	-	-	-	-	-	-	-	-
1000x600x850	19093290	-	19093309	-	19093328	-	19093344	-	19093354	-	Sliding	-	-	-
1100x600x850	19093291	-	19093310	-	19093329	-	-	-	-	-	-	-	-	-
1200x600x850	19093292	-	19093311	-	19093330	-	19093345	-	19093355	-	Sliding	-	-	-
1300x600x850	19093293	-	19093312	-	19093331	-	-	-	-	-	-	-	-	-
1400x600x850	19093294	-	19093313	-	19093332	-	19093346	-	19093356	-	Sliding	19093578	19093584	-
1500x600x850	19093295	-	19093314	-	19093333	-	-	-	-	-	-	-	-	-
1600x600x850	19093296	-	19093315	-	19093334	-	19093347	-	19093357	-	Sliding	19093579	19093585	-
1700x600x850	19093297	-	19093316	-	19093335	-	-	-	-	-	-	-	-	-
1800x600x850	19093298	-	19093317	-	19093336	-	19093348	-	19093358	-	Sliding	19093580	19093586	-
1900x600x850	19093299	-	19093318	-	19093337	-	-	-	-	-	-	-	-	-
2000x600x850	19093300	-	19093319	-	19093338	-	19093349	-	19093359	-	Sliding	19093581	19093587	-
2200x600x850	19093301	-	19093320	-	19093339	-	19093350	-	19093360	-	Sliding	19093582	19093588	-
2400x600x850	19093302	-	19093321	-	19093340	-	19093351	-	19093361	-	Sliding	19093583	19093589	-
2600x600x850	19093303	-	19093322	-	19093341	-	19093352	-	19093362	-	Sliding	-	-	-
2800x600x850	19093304	-	19093323	-	19093342	-	19093353	-	19093363	-	Sliding	-	-	-

## 700 Range

DIMENSIONS (mm)	WITH REINFORCEMENT FRAME	€	WITH ONE (1) SHELF	€	WITH TWO (2) SHELVES	€	WITH DOORS	€	PASS-THROUGH DOORS	€	DOOR TYPE	SLIDING DOORS AND DRAWERS		€
	TCLR-7		TCS1-7		TCS2-7		TCD-7		TCDP-7			TO THE RIGHT	TO THE LEFT	
												TCDDR3R-7	TCDDR3L-7	
600x700x850	19093432	-	19093451	-	19093470	-	-	-	-	-	-	-	-	-
700x700x850	19093433	-	19093452	-	19093471	-	-	-	-	-	-	-	-	-
800x700x850	19093434	-	19093453	-	19093472	-	19093489	-	-	-	Swing	-	-	-
900x700x850	19093435	-	19093454	-	19093473	-	-	-	-	-	-	-	-	-
1000x700x850	19093436	-	19093455	-	19093474	-	19093490	-	19093500	-	Sliding	-	-	-
1100x700x850	19093437	-	19093456	-	19093475	-	-	-	-	-	-	-	-	-
1200x700x850	19093438	-	19093457	-	19093476	-	19093491	-	19093501	-	Sliding	-	-	-
1300x700x850	19093439	-	19093458	-	19093477	-	-	-	-	-	-	-	-	-
1400x700x850	19093440	-	19093459	-	19093478	-	19093492	-	19093502	-	Sliding	19093602	19093608	-
1500x700x850	19093441	-	19093460	-	19093479	-	-	-	-	-	-	-	-	-
1600x700x850	19093442	-	19093461	-	19093480	-	19093493	-	19093503	-	Sliding	19093603	19093609	-
1700x700x850	19093443	-	19093462	-	19093481	-	-	-	-	-	-	-	-	-
1800x700x850	19093444	-	19093463	-	19093482	-	19093494	-	19093504	-	Sliding	19093604	19093610	-
1900x700x850	19093445	-	19093464	-	19093483	-	-	-	-	-	-	-	-	-
2000x700x850	19093446	-	19093465	-	19093484	-	19093495	-	19093505	-	Sliding	19093605	19093611	-
2200x700x850	19093447	-	19093466	-	19093485	-	19093496	-	19093506	-	Sliding	19093606	19093612	-
2400x700x850	19093448	-	19093467	-	19093486	-	19093497	-	19093507	-	Sliding	19093607	19093613	-
2600x700x850	19093449	-	19093468	-	19093487	-	19093498	-	19093508	-	Sliding	-	-	-
2800x700x850	19093450	-	19093469	-	19093488	-	19093499	-	19093509	-	Sliding	-	-	-

# Wall-mounted tables with bowl

 Option customization in length



TWDDR3R-B1L-614



See options

- Worktop made from AISI-304 18/10 stainless steel with satin finish and reinforced with profiles.
- Backsplash of 100 x 15 mm, 50 mm front edge with welded corners.
- Welded bowl of 500 x 400 x 250 mm.
- Square section stainless steel legs 40 x 40 mm.
- Rear legs set back 40 mm for floors with sanitary radius.
- 850 mm height with stainless steel height-adjustable feet (-10 mm / + 50 mm)..
- **Supplied disassembled (except models with doors)**
- **Option shipped assembled.**
- **Option door lock.**

## 600 Range



DIMENSIONS (mm)	WITH REINFORCEMENT FRAME			WITH ONE (1) SHELF								
	BOWL TO THE RIGHT TWLR-B1R-6	€	BOWL TO THE LEFT TWLR-B1L-6	€	BOWL IN CENTER TWLR-B1C-6	€	BOWL TO THE RIGHT TWS1-B1R-6	€	BOWL TO THE LEFT TWS1-B1L-6	€	BOWL IN CENTER TWS1-B1C-6	€
1000x600x850	19093626	-	19093637	-	-	-	19093678	-	19093689	-	-	-
1200x600x850	19093627	-	19093638	-	-	-	19093679	-	19093690	-	-	-
1400x600x850	19093628	-	19093639	-	-	-	19093680	-	19093691	-	-	-
1500x600x850	19093629	-	19093640	-	19093648	-	19093681	-	19093692	-	19093700	-
1600x600x850	19093630	-	19093641	-	19093649	-	19093682	-	19093693	-	19093701	-
1800x600x850	19093631	-	19093642	-	19093650	-	19093683	-	19093694	-	19093702	-
2000x600x850	19093632	-	19093643	-	19093651	-	19093684	-	19093695	-	19093703	-
2200x600x850	19093633	-	19093644	-	-	-	19093685	-	19093696	-	-	-
2400x600x850	19093634	-	19093645	-	-	-	19093686	-	19093697	-	-	-
2600x600x850	19093635	-	19093646	-	-	-	19093687	-	19093698	-	-	-
2800x600x850	19093636	-	19093647	-	-	-	19093688	-	19093699	-	-	-



DIMENSIONS (mm)	WITH SLIDING DOORS			WITH SLIDING DOORS AND DRAWERS						
	BOWL TO THE RIGHT TWD-B1R-6	€	BOWL TO THE LEFT TWD-B1L-6	€	BOWL IN CENTER TWD-B1C-6	€	BOWL TO THE RIGHT TWDDR3L-B1R-6	€	BOWL TO THE LEFT TWDDR3R-B1L-6	€
1000x600x850	19093730	-	19093740	-	-	-	-	-	-	-
1200x600x850	19093731	-	19093741	-	-	-	-	-	-	-
1400x600x850	19093732	-	19093742	-	-	-	19093776	-	19093782	-
1600x600x850	19093733	-	19093743	-	19093750	-	19093777	-	19093783	-
1800x600x850	19093734	-	19093744	-	19093751	-	19093778	-	19093784	-
2000x600x850	19093735	-	19093745	-	19093752	-	19093779	-	19093785	-
2200x600x850	19093736	-	19093746	-	-	-	19093780	-	19093786	-
2400x600x850	19093737	-	19093747	-	-	-	19093781	-	19093787	-
2600x600x850	19093738	-	19093748	-	-	-	-	-	-	-
2800x600x850	19093739	-	19093749	-	-	-	-	-	-	-



## 700 Range



DIMENSIONS (mm)	WITH REINFORCEMENT FRAME			WITH ONE (1) SHELF								
	BOWL TO THE RIGHT TWLR-B1R-7	€	BOWL TO THE LEFT TWLR-B1L-7	€	BOWL IN CENTER TWLR-B1C-7	€	BOWL TO THE RIGHT TWS1-B1R-7	€	BOWL TO THE LEFT TWS1-B1L-7	€	BOWL IN CENTER TWS1-B1C-7	€
1000x700x850	19093652	-	19093663	-	-	-	19093704	-	19093715	-	-	-
1200x700x850	19093653	-	19093664	-	-	-	19093705	-	19093716	-	-	-
1400x700x850	19093654	-	19093665	-	-	-	19093706	-	19093717	-	-	-
1500x700x850	19093655	-	19093666	-	19093674	-	19093707	-	19093718	-	19093726	-
1600x700x850	19093656	-	19093667	-	19093675	-	19093708	-	19093719	-	19093727	-
1800x700x850	19093657	-	19093668	-	19093676	-	19093709	-	19093720	-	19093728	-
2000x700x850	19093658	-	19093669	-	19093677	-	19093710	-	19093721	-	19093729	-
2200x700x850	19093659	-	19093670	-	-	-	19093711	-	19093722	-	-	-
2400x700x850	19093660	-	19093671	-	-	-	19093712	-	19093723	-	-	-
2600x700x850	19093661	-	19093672	-	-	-	19093713	-	19093724	-	-	-
2800x700x850	19093662	-	19093673	-	-	-	19093714	-	19093725	-	-	-



DIMENSIONS (mm)	WITH SLIDING DOORS			WITH SLIDING DOORS AND DRAWERS						
	BOWL TO THE RIGHT TWD-B1R-7	€	BOWL TO THE LEFT TWD-B1L-7	€	BOWL IN CENTER TWD-B1C-7	€	BOWL TO THE RIGHT TWDDR3L-B1R-7	€	BOWL TO THE LEFT TWDDR3R-B1L-7	€
1000x700x850	19093753	-	19093763	-	-	-	-	-	-	-
1200x700x850	19093754	-	19093764	-	-	-	-	-	-	-
1400x700x850	19093755	-	19093765	-	-	-	19093788	-	19093794	-
1600x700x850	19093756	-	19093766	-	19093773	-	19093789	-	19093795	-
1800x700x850	19093757	-	19093767	-	19093774	-	19093790	-	19093796	-
2000x700x850	19093758	-	19093768	-	19093775	-	19093791	-	19093797	-
2200x700x850	19093759	-	19093769	-	-	-	19093792	-	19093798	-
2400x700x850	19093760	-	19093770	-	-	-	19093793	-	19093799	-
2600x700x850	19093761	-	19093771	-	-	-	-	-	-	-
2800x700x850	19093762	-	19093772	-	-	-	-	-	-	-



# Work tables 600 mm high

 Option customization in length



T6CS1-614



See options

- Designed to support cooking appliances and place the working height at 850-900 mm.
- Worktop made from AISI-304 18/10 stainless steel with satin finish and reinforced with profiles.
- Backsplash of 100 x 15 mm, 50 mm front edge with welded corners.
- Square section stainless steel legs 40 x 40 mm.
- Rear legs set back 40 mm for floors with sanitary radius.
- 600 mm height with stainless steel height-adjustable feet (-10 mm / + 50 mm).
- **Supplied disassembled.**
- **Option shipped assembled.**



## 600 Range



DIMENSIONS (mm)	WALL-MOUNTED TABLE				CENTRAL TABLE			
	WITH REINFORCEMENT FRAME		WITH ONE (1) SHELF		WITH REINFORCEMENT FRAME		WITH ONE (1) SHELF	
	T6WLR-6	€	T6WS1-6	€	T6CLR-6	€	T6CS1-6	€
600x600x600	19093996	-	19094015	-	19093958	-	19093977	-
700x600x600	19093997	-	19094016	-	19093959	-	19093978	-
800x600x600	19093998	-	19094017	-	19093960	-	19093979	-
900x600x600	19093999	-	19094018	-	19093961	-	19093980	-
1000x600x600	19094000	-	19094019	-	19093962	-	19093981	-
1100x600x600	19094001	-	19094020	-	19093963	-	19093982	-
1200x600x600	19094002	-	19094021	-	19093964	-	19093983	-
1300x600x600	19094003	-	19094022	-	19093965	-	19093984	-
1400x600x600	19094004	-	19094023	-	19093966	-	19093985	-
1500x600x600	19094005	-	19094024	-	19093967	-	19093986	-
1600x600x600	19094006	-	19094025	-	19093968	-	19093987	-
1700x600x600	19094007	-	19094026	-	19093969	-	19093988	-
1800x600x600	19094008	-	19094027	-	19093970	-	19093989	-
1900x600x600	19094009	-	19094028	-	19093971	-	19093990	-
2000x600x600	19094010	-	19094029	-	19093972	-	19093991	-
2200x600x600	19094011	-	19094030	-	19093973	-	19093992	-
2400x600x600	19094012	-	19094031	-	19093974	-	19093993	-
2600x600x600	19094013	-	19094032	-	19093975	-	19093994	-
2800x600x600	19094014	-	19094033	-	19093976	-	19093995	-

## 700 Range



DIMENSIONS (mm)	WALL-MOUNTED TABLE				CENTRAL TABLE			
	WITH REINFORCEMENT FRAME		WITH ONE (1) SHELF		WITH REINFORCEMENT FRAME		WITH ONE (1) SHELF	
	T6WLR-7	€	T6WS1-7	€	T6CLR-7	€	T6CS1-7	€
600x700x600	19094072	-	19094091	-	19094034	-	19094053	-
700x700x600	19094073	-	19094092	-	19094035	-	19094054	-
800x700x600	19094074	-	19094093	-	19094036	-	19094055	-
900x700x600	19094075	-	19094094	-	19094037	-	19094056	-
1000x700x600	19094076	-	19094095	-	19094038	-	19094057	-
1100x700x600	19094077	-	19094096	-	19094039	-	19094058	-
1200x700x600	19094078	-	19094097	-	19094040	-	19094059	-
1300x700x600	19094079	-	19094098	-	19094041	-	19094060	-
1400x700x600	19094080	-	19094099	-	19094042	-	19094061	-
1500x700x600	19094081	-	19094100	-	19094043	-	19094062	-
1600x700x600	19094082	-	19094101	-	19094044	-	19094063	-
1700x700x600	19094083	-	19094102	-	19094045	-	19094064	-
1800x700x600	19094084	-	19094103	-	19094046	-	19094065	-
1900x700x600	19094085	-	19094104	-	19094047	-	19094066	-
2000x700x600	19094086	-	19094105	-	19094048	-	19094067	-
2200x700x600	19094087	-	19094106	-	19094049	-	19094068	-
2400x700x600	19094088	-	19094107	-	19094050	-	19094069	-
2600x700x600	19094089	-	19094108	-	19094051	-	19094070	-
2800x700x600	19094090	-	19094109	-	19094052	-	19094071	-

# Worktops

- Worktop made from AISI-304 18/10 stainless steel with satin finish and reinforced with profiles.

- Backsplash of 100 x 15 mm, 50 mm front edge with welded corners.

- Designed to be mounted on wall brackets.



TTC-714



See options

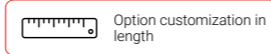

## Flat worktops

### 600 Range

DIMENSIONS (mm)	WALL-MOUNTED		CENTRAL	
	TTW-6	€	TTC-6	€
600x600	19093823	-	19093800	-
700x600	19093824	-	19093801	-
800x600	19093825	-	19093802	-
900x600	19093826	-	19093803	-
1000x600	19093827	-	19093804	-
1100x600	19093828	-	19093805	-
1200x600	19093829	-	19093806	-
1300x600	19093830	-	19093807	-
1400x600	19093831	-	19093808	-
1500x600	19093832	-	19093809	-
1600x600	19093833	-	19093810	-
1700x600	19093834	-	19093811	-
1800x600	19093835	-	19093812	-
1900x600	19093836	-	19093813	-
2000x600	19093837	-	19093814	-
2100x600	19093838	-	19093815	-
2200x600	19093839	-	19093816	-
2300x600	19093840	-	19093817	-
2400x600	19093841	-	19093818	-
2500x600	19093842	-	19093819	-
2600x600	19093843	-	19093820	-
2700x600	19093844	-	19093821	-
2800x600	19093845	-	19093822	-

### 700 Range

DIMENSIONS (mm)	WALL-MOUNTED		CENTRAL	
	TTW-7	€	TTC-7	€
600x700	19093869	-	19093846	-
700x700	19093870	-	19093847	-
800x700	19093871	-	19093848	-
900x700	19093872	-	19093849	-
1000x700	19093873	-	19093850	-
1100x700	19093874	-	19093851	-
1200x700	19093875	-	19093852	-
1300x700	19093876	-	19093853	-
1400x700	19093877	-	19093854	-
1500x700	19093878	-	19093855	-
1600x700	19093879	-	19093856	-
1700x700	19093880	-	19093857	-
1800x700	19093881	-	19093858	-
1900x700	19093882	-	19093859	-
2000x700	19093883	-	19093860	-
2100x700	19093884	-	19093861	-
2200x700	19093885	-	19093862	-
2300x700	19093886	-	19093863	-
2400x700	19093887	-	19093864	-
2500x700	19093888	-	19093865	-
2600x700	19093889	-	19093866	-
2700x700	19093890	-	19093867	-
2800x700	19093891	-	19093868	-



TTW-B1C-614



See options

## Worktops with bowl

- Welded bowl of 500 x 400 x 250 mm.

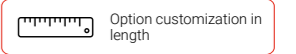

### 600 Range

DIMENSIONS (mm)	BOWL TO THE RIGHT		BOWL TO THE LEFT		BOWL IN CENTER	
	TTW-B1R-6	€	TTW-B1L-6	€	TTW-B1C-6	€
1000x600	19093892	-	19093903	-	19093914	-
1200x600	19093893	-	19093904	-	19093915	-
1400x600	19093894	-	19093905	-	19093916	-
1500x600	19093895	-	19093906	-	19093917	-
1600x600	19093896	-	19093907	-	19093918	-
1800x600	19093897	-	19093908	-	19093919	-
2000x600	19093898	-	19093909	-	19093920	-
2200x600	19093899	-	19093910	-	19093921	-
2400x600	19093900	-	19093911	-	19093922	-
2600x600	19093901	-	19093912	-	19093923	-
2800x600	19093902	-	19093913	-	19093924	-

### 700 Range

DIMENSIONS (mm)	BOWL TO THE RIGHT		BOWL TO THE LEFT		BOWL IN CENTER	
	TTW-B1R-7	€	TTW-B1L-7	€	TTW-B1C-7	€
1000x700	19093925	-	19093936	-	19093947	-
1200x700	19093926	-	19093937	-	19093948	-
1400x700	19093927	-	19093938	-	19093949	-
1500x700	19093928	-	19093939	-	19093950	-
1600x700	19093929	-	19093940	-	19093951	-
1800x700	19093930	-	19093941	-	19093952	-
2000x700	19093931	-	19093942	-	19093953	-
2200x700	19093932	-	19093943	-	19093954	-
2400x700	19093933	-	19093944	-	19093955	-
2600x700	19093934	-	19093945	-	19093956	-
2800x700	19093935	-	19093946	-	19093957	-



## Wall brackets

- Made from stainless steel.
- Compatible with worktops and 600/700 range sinks, except 600 x 600 mm and pot wash sinks.

DESCRIPTION	MODEL	CODE	€/UNIT
Wall bracket	C-6	19092785	-
Bracket with leg	CP-6	19092786	-

## Wall-mounted tables with drawers



See options

- Closed structure with module with three (3) drawers.
- Lower base reinforced with profile to guarantee greater robustness.
- Removable drawers with telescopic sliding guides.

- Effective dimensions of the drawer 304 x 435 x 105 mm.
- 850 mm height with stainless steel height-adjustable feet (-10 mm / + 50 mm).
- **Supplied assembled.**

RANGE	MODEL	CODE	DIMENSIONS (mm)	DRAWERS	€
600	TWDR3-65	19094112	500x600x850	3	-
700	TWDR3-75	19094113	500x700x850	3	-

## Corner tables

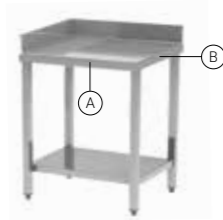

See options

### With intermediate shelves

- Shelf made from stainless steel with satin finish and reinforcements in profile.
- Shelf assembly done by fixing four (4) screws.
- 850 mm height with stainless steel height-

adjustable feet (-10 mm / + 50 mm).

- **Supplied disassembled.**
- **Option shipped assembled.**

DIMENSIONS (mm)		MODEL	WITH ONE (1) SHELF	€	MODEL	WITH TWO (2) SHELVES	€
A	B						
600 x 600		T90WS1-66	19094114	-	T90WS2-66	19094118	-
700 x 700		T90WS1-77	19094115	-	T90WS2-77	19094119	-
600 x 700		T90WS1-67	19094116	-	T90WS2-67	19094120	-
700 x 600		T90WS1-76	19094117	-	T90WS2-76	19094121	-



See options

### With door

- Closed structure with doors.
- Lower base reinforced with profile to guarantee greater robustness.
- 850 mm height with stainless steel height-

adjustable feet (-10 mm / + 50 mm).

- **Supplied assembled.**
- **Option door lock.**

RANGE	MODEL	CODE	DIMENSIONS (mm)	€
600	T90WD-6	19094122	1000x1000x600x850	-
700	T90WD-7	19094123	1000x1000x700x850	-

## Waste collection tables



See options

- Worktop made from AISI-304 18/10 stainless steel with satin finish and reinforced with profiles.
- Sorting hole with rubber ring to throw waste. A waste bin (not included) with maximum diameter of 460 mm could be placed under the counter.
- Backsplash of 100 x 15 mm, 50 mm front edge with welded corners.

- Square section stainless steel legs 40 x 40 mm.
- Rear legs set back 40 mm for floors with sanitary radius.
- 850 mm height with stainless steel height-adjustable feet (-10 mm / + 50 mm).
- **Supplied assembled.**

RANGE	MODEL	CODE	DIMENSIONS (mm)	€
600	TWD-R-67	19094110	700x600x850	-
700	TWD-R-77	19094111	700x700x850	-

## Recycling tables

- Designed for the classification and collection of waste.
- Worktop made from AISI-304 18/10 stainless steel with satin finish and reinforced with profiles.
- Square section stainless steel legs

40 x 40 mm.

- Ø195 mm holes for placing rubber rings.

- Rubber ring (not included) to throw waste. A waste bin (not included) with maximum diameter of 460 mm could be placed under the counter.

- 850 mm height with stainless steel height-adjustable feet (-10 mm / + 50 mm).

- **Supplied disassembled.**
- **Option shipped assembled.**



See options



See options

### Wall-mounted

MODEL	CODE	DIMENSIONS (mm)	HOLES	€
<b>ADULTS</b>				
TWLR-R-612	19094126	1200x600x850	2	-
TWLR-R-617	19094127	1700x600x850	3	-
<b>KIDS</b>  <i>kids</i>				
TWLR-R-K-612	19094260	1200x600x700	2	-
TWLR-R-K-617	19094261	1700x600x700	3	-

### Central

MODEL	CODE	DIMENSIONS (mm)	HOLES	€
<b>ADULTS</b>				
TCLR-R-612	19094124	1200x600x850	2	-
TCLR-R-617	19094125	1700x600x850	3	-
<b>KIDS</b>  <i>kids</i>				
TCLR-R-K-612	19094258	1200x600x700	2	-
TCLR-R-K-617	19094259	1700x600x700	3	-



### Rubber ring

- Removable internal Ø162 mm rubber ring that facilitates the identification of the container.
- Easy to clean and disinfect.

MODEL	CODE	COLOR	€
R-Y232	19092787	Yellow	-
R-B232	19092788	Blue	-
R-R232	19092789	Red	-
R-G232	19092790	Green	-

## Countertop shelves



F2H-313



See options

- Made from stainless steel with satin finish.
- Easy installation by making small holes on the worktop where the joining brackets are placed.
- To be attached to all types of work tables.
- **Supplied disassembled.**

### Single

TABLE SIZE (mm)	DIMENSIONS (mm)	NEUTRAL		Hz	VOLTAGE	HALOGEN LIGHT AND HEAT		POWER (W)	€	CERAMIC HEAT		POWER (W)	€
		F1N-3	€			F1H-3	€			F1C-3	€		
1000	700x350x400	19094128	-	50/60	230V 1N	-	-	-	-	-	-	-	-
1200	900x350x400	19094129	-	50/60	230V 1N	19094138	600	-	19094147	500	-	-	-
1400	1100x350x400	19094130	-	50/60	230V 1N	19094139	600	-	19094148	500	-	-	-
1600	1300x350x400	19094131	-	50/60	230V 1N	19094140	900	-	19094149	750	-	-	-
1800	1500x350x400	19094132	-	50/60	230V 1N	19094141	900	-	19094150	750	-	-	-
2000	1700x350x400	19094133	-	50/60	230V 1N	19094142	1200	-	19094151	1000	-	-	-
2200	1900x350x400	19094134	-	50/60	230V 1N	19094143	1200	-	19094152	1000	-	-	-
2400	2100x350x400	19094135	-	50/60	230V 1N	19094144	1500	-	19094153	1250	-	-	-
2600	2300x350x400	19094136	-	50/60	230V 1N	19094145	1500	-	19094154	1250	-	-	-
2800	2500x350x400	19094137	-	50/60	230V 1N	19094146	1800	-	19094155	1500	-	-	-

### Double

TABLE SIZE (mm)	DIMENSIONS (mm)	NEUTRAL		Hz	VOLTAGE	HALOGEN LIGHT AND HEAT		POWER (W)	€	CERAMIC HEAT		POWER (W)	€
		F2N-3	€			F2H-3	€			F2C-3	€		
1000	700x350x700	19094156	-	-	-	-	-	-	-	-	-	-	-
1200	900x350x700	19094157	-	50/60	230V 1N	19094166	1200	-	19094175	1000	-	-	-
1400	1100x350x700	19094158	-	50/60	230V 1N	19094167	1200	-	19094176	1000	-	-	-
1600	1300x350x700	19094159	-	50/60	230V 1N	19094168	1800	-	19094177	1500	-	-	-
1800	1500x350x700	19094160	-	50/60	230V 1N	19094169	1800	-	19094178	1500	-	-	-
2000	1700x350x700	19094161	-	50/60	230V 1N	19094170	2400	-	19094179	2000	-	-	-
2200	1900x350x700	19094162	-	50/60	230V 1N	19094171	2400	-	19094180	2000	-	-	-
2400	2100x350x700	19094163	-	50/60	230V 1N	19094172	3000	-	19094181	2500	-	-	-
2600	2300x350x700	19094164	-	50/60	230V 1N	19094173	3000	-	19094182	2500	-	-	-
2800	2500x350x700	19094165	-	50/60	230V 1N	19094174	3600	-	19094183	3000	-	-	-

### Lamp strip



DIMENSIONS (mm)	Hz	VOLTAGE	MODEL	HALOGEN LIGHT AND HEAT	POWER (W)	€	MODEL	CERAMIC HEAT	POWER (W)	€
800x150x60	50/60	230V 1N	H-8	19092791	600	-	C-8	19092795	500	-
1200x150x60	50/60	230V 1N	H-12	19092792	900	-	C-12	19092796	750	-
1600x150x60	50/60	230V 1N	H-16	19092793	1200	-	C-16	19092797	1000	-
2000x150x60	50/60	230V 1N	H-20	19092794	1500	-	C-20	19092798	1250	-

## Accessories



### Sliding guide drawer kit

- Made from stainless steel.
- Removable drawer equipped with telescopic guides with brake.
- Ease of assembly without the need for welding.
- To be assembled to tables, except in the 500 range.

MODEL	CODE	DIMENSIONS (mm)	€
DR1	19092799	460x450x150	-



### Drawer module

- Made from stainless steel.
- Removable drawers equipped with telescopic guides with brake.
- Ease of assembly without the need for welding.
- To be assembled to tables with shelf, except in the 500 range.

RANGE	MODEL	CODE	DIMENSIONS (mm)	DRAWERS	€
600	DR2-64	19092800	465x510x600	2	-
	DR3-64	19092801	465x510x600	3	-
700	DR2-74	19092802	465x610x600	2	-
	DR3-74	19092803	465x610x600	3	-



### Large capacity drawer module

- Specially designed to be used as a bread dispenser, to place waste bags or other applications.
- Made from stainless steel.
- Removable drawer equipped with telescopic guides with brake.
- Ease of assembly without the need for welding.
- To be assembled to tables with shelf, except in the 500 range.

RANGE	MODEL	CODE	DIMENSIONS (mm)	€
600	DR1-64	19092804	465x510x600	-
700	DR1-74	19092805	465x610x600	-

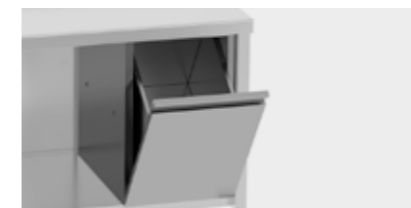

### Waste bin hopper module

- Specially designed to be used as a garbage hopper.
- Made from stainless steel.
- Opening with folding lid.
- Ease of assembly without the need for welding.
- To be assembled to tables with shelf, except in the 500 range.

CAPACITY	MODEL	CODE	DIMENSIONS (mm)	€
600	WH-6	19106211	400x510x600	-
700	WH-7	19106212	400x610x600	-



### Rack module

- Made from stainless steel.
- Ease of assembly without the need for welding.
- Eight (8) pairs of guides with a separation of 70 mm.
- To be assembled to tables with shelf, except in the 500 range.

CAPACITY	MODEL	CODE	DIMENSIONS (mm)	€
1xGN 1/1	GS-35	19092806	380x560x590	-
600x400	GS-46	19092807	660x436x596	-



### Side panel

- Designed to protect walkways and divide storage areas.
- Made from stainless steel.
- Ease of assembly without the need for welding.
- To be assembled to tables with shelf.

RANGE	MODEL	CODE	€
500	SP-5	19092808	-
600	SP-6	19092809	-
700	SP-7	19092810	-

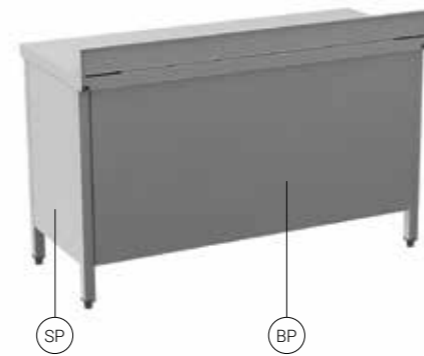

### Back panel

- Designed to protect walkways and divide storage areas.
- Made from stainless steel.
- Ease of assembly without the need for welding.
- To be assembled to tables with shelf.

MODEL	TABLE SIZE (mm)	CODE	€
BP-6	600	19094184	-
BP-7	700	19094185	-
BP-8	800	19094186	-
BP-9	900	19094187	-
BP-10	1000	19094188	-
BP-11	1100	19094189	-
BP-12	1200	19094190	-
BP-13	1300	19094191	-
BP-14	1400	19094192	-
BP-15	1500	19094193	-

MODEL	TABLE SIZE (mm)	CODE	€
BP-16	1600	19094194	-
BP-17	1700	19094195	-
BP-18	1800	19094196	-
BP-19	1900	19094197	-
BP-20	2000	19094198	-
BP-22	2200	19094199	-
BP-24	2400	19094200	-
BP-26	2600	19094201	-
BP-28	2800	19094202	-

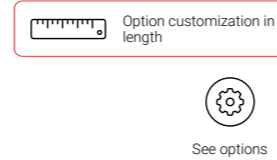

### Detached side splash

- Specially designed to be assembled easily on any sink.
- Made from AISI-304 18/10 stainless steel.

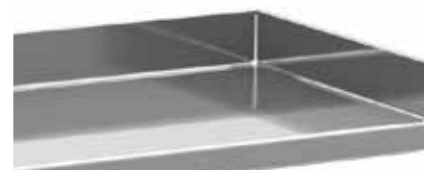

RANGE	MODEL	CODE	POSITION	€
500	TPB-5 R	19092811	Right	-
	TPB-5 L	19092812	Left	-
600	TPB-6 R	19092813	Right	-
	TPB-6 L	19092814	Left	-
700	TPB-7 R	19092815	Right	-
	TPB-7 L	19092816	Left	-

### Shelves

- Made from AISI-304 18/10 stainless steel with satin finish.
- Lower base reinforced with profile to guarantee greater robustness.
- Better space usage since shelves could be added and assembled later.
- Assembly by fixing four (4) screws.

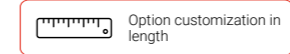

NS-614



TABLE SIZE (mm)	CODE (500 RANGE)	€	CODE (600 RANGE)	€	CODE (700 RANGE)	€
	NS-5		NS-6		NS-7	
600	19094209	-	19094220	-	19094239	-
700	-	--	19094221	-	19094240	-
800	19094210	-	19094222	-	19094241	-
900	-	-	19094223	-	19094242	-
1000	19094211	-	19094224	-	19094243	-
1100	-	-	19094225	-	19094244	-
1200	19094212	-	19094226	-	19094245	-
1300	-	-	19094227	-	19094246	-
1400	19094213	-	19094228	-	19094247	-
1500	19094214	-	19094229	-	19094248	-
1600	19094215	-	19094230	-	19094249	-
1700	-	-	19094231	-	19094250	-
1800	19094216	-	19094232	-	19094251	-
1900	-	-	19094233	-	19094252	-
2000	19094217	-	19094234	-	19094253	-
2200	19094218	-	19094235	-	19094254	-
2400	19094219	-	19094236	-	19094255	-
2600	-	-	19094237	-	19094256	-
2800	-	-	19094238	-	19094257	-

### Sorting hole lid

- Specially designed to be placed on the sorting hole to cover it.



MODEL	CODE	€
RL-232	19092820	-

### Castor kit

- Ø125 mm castors.
- Assembled in the square legs of 40 x 40 mm.



MODEL	CODE	No. CASTORS	TABLE LENGTH	€
CK-4	19092817	4	<= 2000 mm	-
CK-5	19092818	5	corner tables with door	-
CK-6	19092819	6	> 2000 mm	-

# Options

Option shipped assembled.

ABBREVIATION	CODE	DIMENSIONS (mm)	€
A	0201-0001	Up to 1200 mm	-
A	0201-0002	Up to 2000 mm	-
A	0201-0003	Up to 2800 mm	-

Option customization in length

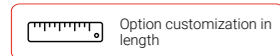

Indicate the code and price of the next higher model and the desired length.

Option stainless steel reinforcements with profile.

DIMENSIONS (mm)	ABBREVIATION	WORKTOP	€	ABBREVIATION	ONE (1) SHELF	€	ABBREVIATION	WORKTOP AND ONE (1) SHELF	€	ABBREVIATION	WORKTOP AND TWO (2) SHELVES	€
Up to 1200 mm	ST	0205-0001	-	SS	0205-0006	-	STS	0205-0011	-	ST2S	0205-0016	-
Up to 1600 mm	ST	0205-0002	-	SS	0205-0007	-	STS	0205-0012	-	ST2S	0205-0017	-
Up to 2000 mm	ST	0205-0003	-	SS	0205-0008	-	STS	0205-0013	-	ST2S	0205-0018	-
Up to 2400 mm	ST	0205-0004	-	SS	0205-0009	-	STS	0205-0014	-	ST2S	0205-0019	-
Up to 2800 mm	ST	0205-0005	-	SS	0205-0010	-	STS	0205-0015	-	ST2S	0205-0020	-

Option door lock.

ABBREVIATION	CODE	DESCRIPTION	€
CR	0206-0001	One (1) lock	-
CR	0206-0002	Two (2) locks	-
CR	0206-0004	Four (4) locks	-

Option faucet hole Ø 33 mm.

ABBREVIATION	CODE	DESCRIPTION	€
33R1	0208-0001	One (1) hole to the right	-
33L1	0208-0002	One (1) hole to the left	-
33C1	0208-0003	One (1) hole centered	-

Option element height.

ABBREVIATION	CODE	DIMENSIONS (mm)	€
H9	0202-0001	900 mm (-10/+50)	-

Note: applies to 600 and 700mm width sinks.

Option 1.5 mm thickness worktop.

ABBREVIATION	CODE	DIMENSIONS (mm)	€
1,5	0204-0001	Up to 1200 mm	-
1,5	0204-0002	Up to 2000 mm	-
1,5	0204-0003	Up to 2800 mm	-

Option side splash folded and welded to the worktop.

ABBREVIATION	CODE	SIDE	€
SPR	0207-0001	Right	-
SPL	0207-0002	Left	-
SPRL	0207-0003 *	Right + Left	-

\* Maximum length up to 2600 mm.

Option one (1) sorting hole with black rubber ring on the worktop to throw waste.

ABBREVIATION	CODE	DESCRIPTION	€
RR	0209-0001	One (1) hole with ring to the right	-
RL	0209-0002	One (1) hole with ring to the left	-
RC	0209-0003	One (1) hole with ring centered	-
RCR	0209-0004	One (1) hole with ring on the center right. From 2200 mm worktops on.	-
RCL	0209-0005	One (1) hole with ring on the center left. From 2200 mm worktops on.	-
R	0209-0006	One (1) custom sorting hole.	-

# Wall-mounted cabinets



- Specially designed to optimize available space in professional kitchens.
- Entirely made from stainless steel.
- Wall anchor system, including all accessories needed for installation.
- Height-adjustable intermediate shelf.
- **Supplied assembled.**

Open



Swing doors



MODEL	CODE	DIMENSIONS (mm)	€
CWS1-410	19092847	1000x400x600	-
CWS1-412	19092848	1200x400x600	-
CWS1-414	19092849	1400x400x600	-
CWS1-416	19092850	1600x400x600	-
CWS1-418	19092851	1800x400x600	-

MODEL	CODE	DIMENSIONS (mm)	No. DOORS	€
CWHD-45	19092845	500x400x600	1	-
CWHD-410	19092846	1000x400x600	2	-

Sliding doors



MODEL	CODE	DIMENSIONS (mm)	€
CWD-410	19092852	1000x400x600	-
CWD-412	19092853	1200x400x600	-
CWD-414	19092854	1400x400x600	-
CWD-416	19092855	1600x400x600	-
CWD-418	19092856	1800x400x600	-

Corner cabinet with door



- Model to join wall-mounted cabinets in 90° angle corners.

MODEL	CODE	DIMENSIONS (mm)	€
C90WD-4	19092859	700x400x600	-

### Sliding doors with drainer



- Model with storing capacity of 36 plates with max Ø280 mm.

MODEL	CODE	DIMENSIONS (mm)	€
CWDD-410	19092857	1000x400x600	-
CWDD-412	19092858	1200x400x600	-

### Hanging spice rack



- Made of stainless steel.  
- Support for pans to be placed under the cabinets (pans not included).

MODEL	CODE	€
GNS-4	19092860	-

FOR CABINETS LENGTH (MM)	QUANTITY OF SPICE RACKS TO ORDER
500	2
1000	5
1200	6
1400	7
1600	8
1800	9

## High cabinets

### Cupboards

- Specially designed to optimize available space in professional kitchens.  
- Entirely made from stainless steel.  
- Three (3) intermediate stainless steel shelves with reinforcements in

profile. The central shelf is fixed, the other two are height-adjustable.  
- Key lock included.  
- **Supplied assembled.**

### With swing doors



MODEL	CODE	DIMENSIONS (mm)	No. DOORS	€
CSHD-66	19092862	600x600x1900	1	-
CSHD-610	19092863	1000x600x1900	2	-

### With sliding doors



MODEL	CODE	DIMENSIONS (mm)	€
CSD-612	19092864	1200x600x1900	-
CSD-614	19092865	1400x600x1900	-
CSD-616	19092866	1600x600x1900	-

### Janitorial cabinets

- Specially designed to optimize available space in professional kitchens.  
- Entirely made from stainless steel.  
- Three (3) intermediate stainless steel shelves with reinforcements in profile. The central shelf is fixed, the other two are height-adjustable.  
- Key lock included.



MODEL	CODE	DIMENSIONS (mm)	No. DOORS	€
CCHD-66	19092874	600x600x1900	1	-
CCHD-610	19092875	1000x600x1900	2	-

### Sloped roof

- Specially designed to prevent dust and dirt built-up on the upper part of the cabinet.  
- Made of stainless steel.  
- Easy installation on cupboards



DIMENSIONS (mm)	MODEL	CODE	€
600x600x200	CSHDIP-66	19092867	-
1000x600x200	CSHDIP-610	19092868	-
1200x600x200	CSDIP-612	19092871	-
1400x600x200	CSDIP-614	19092872	-
1600x600x200	CSDIP-616	19092873	-

### Utensil bar

- Made of AISI 304 18/10 stainless steel  
- Welded plates with holes to fix to the wall (plugs and screws included).

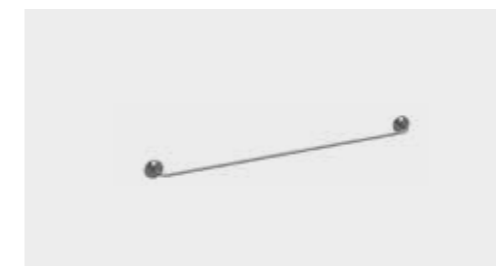

MODEL	CODE	DIMENSIONS (mm)	€
UH-6	19092861	600x40x40	-

# Neutral-hot element composition

- Elements with shelves..... **471**
- Elements with sliding doors ..... **472**
- Elements with swing doors ..... **473**
- Elements with drawers..... **474**
- Elements with sliding doors  
and drawers ..... **475**
- Hot elements ..... **477**
- Elements with rack module ..... **478**
- 600 mm height elements ..... **479**
- Corner elements ..... **480**
- Waste collection elements..... **480**
- Elements with sink..... **481**
- Worktops..... **483**
- Recycling station elements ..... **485**
- Accessories..... **486**
- Options ..... **487**

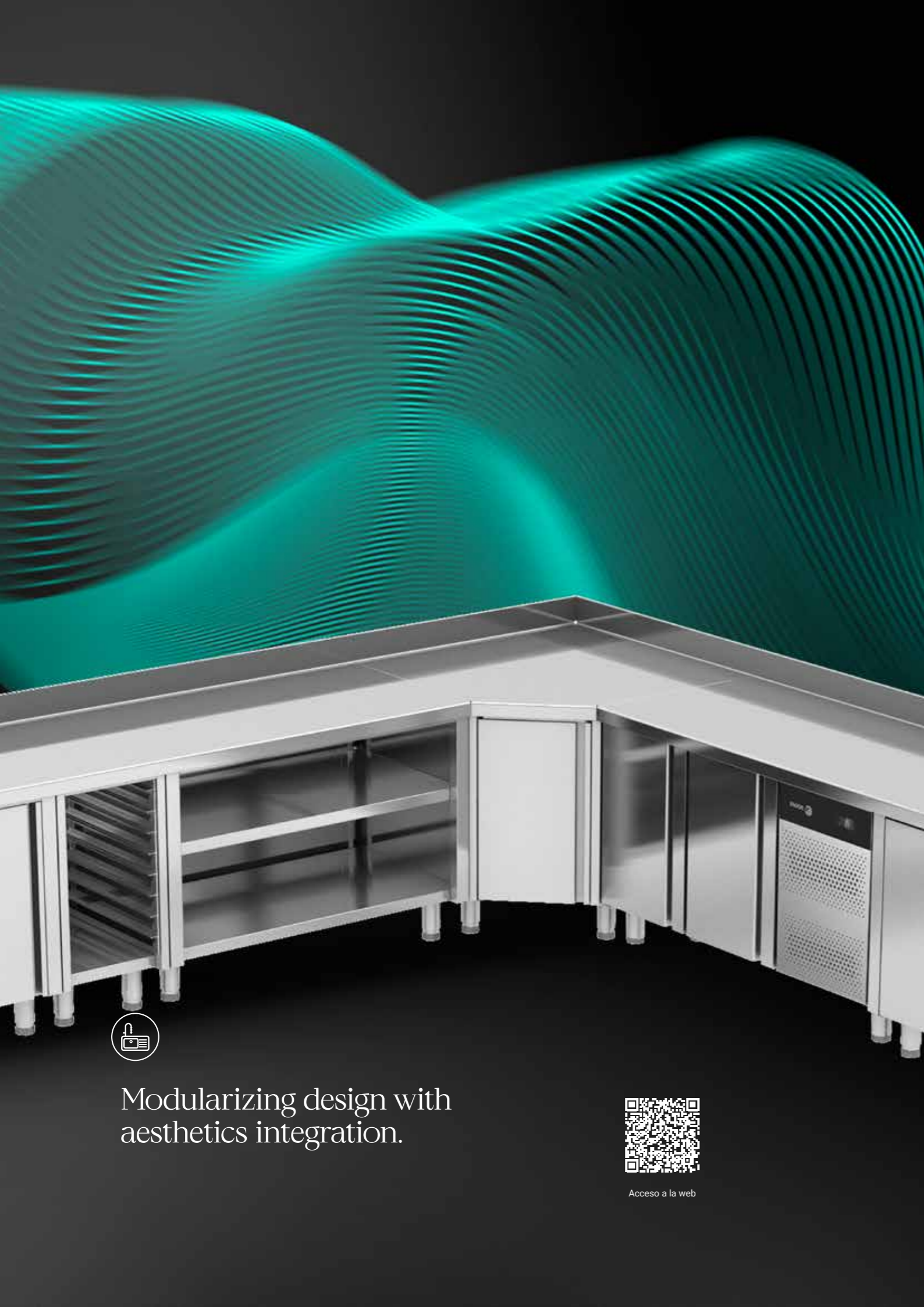

Modularizing design with  
aesthetics integration.



Acceso a la web



## Elements with shelves

 Option customization in length



TMWS1-614



See options

- Worktop made from AISI-304 18/10 stainless steel with satin finish.
- Backsplash of 100 x 15 mm and 50 mm front edge with welded corners.
- Modular element with closed structure made from stainless steel, fully integrable with the rest of neutral and hot elements, through a common or independent worktop.
- Lower base reinforced with profile to guarantee greater robustness.

- 850 mm height with stainless steel height-adjustable feet (-10 mm / + 50 mm).
- **Supplied assembled.**

### 600 Range



DIMENSIONS (mm)	WALL-MOUNTED	€	CENTRAL	€	WITHOUT WORKTOP	€	PASSTHROUGH	€	PASSTHROUGH WITHOUT WORKTOP	€
	TMWS1-6		TMCS1-6		TMS1-6 SE		TMPS1-6		TMPS1-6 SE	
600x600x850	19094353	-	19094363	-	19094373	-	19094313	-	19094323	-
800x600x850	19094354	-	19094364	-	19094374	-	19094314	-	19094324	-
1000x600x850	19094355	-	19094365	-	19094375	-	19094315	-	19094325	-
1200x600x850	19094356	-	19094366	-	19094376	-	19094316	-	19094326	-
1400x600x850	19094357	-	19094367	-	19094377	-	19094317	-	19094327	-
1600x600x850	19094358	-	19094368	-	19094378	-	19094318	-	19094328	-
1800x600x850	19094359	-	19094369	-	19094379	-	19094319	-	19094329	-
2000x600x850	19094360	-	19094370	-	19094380	-	19094320	-	19094330	-
2200x600x850	19094361	-	19094371	-	19094381	-	19094321	-	19094331	-
2400x600x850	19094362	-	19094372	-	19094382	-	19094322	-	19094332	-

### 700 Range

DIMENSIONS (mm)	WALL-MOUNTED	€	CENTRAL	€	WITHOUT WORKTOP	€	PASSTHROUGH	€	PASSTHROUGH WITHOUT WORKTOP	€
	TMWS1-7		TMCS1-7		TMS1-7 SE		TMPS1-7		TMPS1-7 SE	
600x700x850	19094383	-	19094393	-	19094403	-	19094333	-	19094343	-
800x700x850	19094384	-	19094394	-	19094404	-	19094334	-	19094344	-
1000x700x850	19094385	-	19094395	-	19094405	-	19094335	-	19094345	-
1200x700x850	19094386	-	19094396	-	19094406	-	19094336	-	19094346	-
1400x700x850	19094387	-	19094397	-	19094407	-	19094337	-	19094347	-
1600x700x850	19094388	-	19094398	-	19094408	-	19094338	-	19094348	-
1800x700x850	19094389	-	19094399	-	19094409	-	19094339	-	19094349	-
2000x700x850	19094390	-	19094400	-	19094410	-	19094340	-	19094350	-
2200x700x850	19094391	-	19094401	-	19094411	-	19094341	-	19094351	-
2400x700x850	19094392	-	19094402	-	19094412	-	19094342	-	19094352	-

## Elements with sliding doors

 Option customization in length



TMWD-614



See options

- Worktop made from AISI-304 18/10 stainless steel with satin finish.
- Backsplash of 100 x 15 mm and 50 mm front edge with welded corners.
- Modular element with closed structure made from stainless steel, fully integrable with the rest of neutral and hot elements, through a common or independent worktop.
- Lower base reinforced with profile to guarantee greater robustness.

- 850 mm height with stainless steel height-adjustable feet (-10 mm / + 50 mm).
- **Supplied assembled.**
- **Option door lock.**

### 600 Range



DIMENSIONS (mm)	WALL-MOUNTED	€	CENTRAL	€	WITHOUT WORKTOP	€	FOR WORKTOPS WITH BOWL	€	PASSTHROUGH	€	PASSTHROUGH WITHOUT WORKTOP	€
	TMWD-6		TMCD-6		TMD-6 SE		TMD-6 OB SE		TMDP-6		TMDP-6 SE	
1000x600x850	19094437	-	19094443	-	19094449	-	19094455	-	19094413	-	19094419	-
1200x600x850	19094438	-	19094444	-	19094450	-	19094456	-	19094414	-	19094420	-
1400x600x850	19094439	-	19094445	-	19094451	-	19094457	-	19094415	-	19094421	-
1600x600x850	19094440	-	19094446	-	19094452	-	19094458	-	19094416	-	19094422	-
1800x600x850	19094441	-	19094447	-	19094453	-	19094459	-	19094417	-	19094423	-
2000x600x850	19094442	-	19094448	-	19094454	-	19094460	-	19094418	-	19094424	-

### 700 Range

DIMENSIONS (mm)	WALL-MOUNTED	€	CENTRAL	€	WITHOUT WORKTOP	€	FOR WORKTOPS WITH BOWL	€	PASSTHROUGH	€	PASSTHROUGH WITHOUT WORKTOP	€
	TMWD-7		TMCD-7		TMD-7 SE		TMD-7 OB SE		TMDP-7		TMDP-7 SE	
1000x700x850	19094461	-	19094467	-	19094473	-	19094479	-	19094425	-	19094431	-
1200x700x850	19094462	-	19094468	-	19094474	-	19094480	-	19094426	-	19094432	-
1400x700x850	19094463	-	19094469	-	19094475	-	19094481	-	19094427	-	19094433	-
1600x700x850	19094464	-	19094470	-	19094476	-	19094482	-	19094428	-	19094434	-
1800x700x850	19094465	-	19094471	-	19094477	-	19094483	-	19094429	-	19094435	-
2000x700x850	19094466	-	19094472	-	19094478	-	19094484	-	19094430	-	19094436	-

## Elements with swing doors



TMWHD-68



See options

- Worktop made from AISI-304 18/10 stainless steel with satin finish.
- Backsplash of 100 x 15 mm and 50 mm front edge with welded corners.
- Modular element with closed structure made from stainless steel, fully integrable with the rest of neutral and hot elements, through a common or independent worktop.
- Lower base reinforced with profile to guarantee greater robustness.
- 850 mm height with stainless steel height-adjustable feet (-10 mm / + 50 mm).
- **Supplied assembled.**
- **Option door lock.**



### 600 Range

DIMENSIONS (mm)	WALL-MOUNTED	€	CENTRAL	€	WITHOUT WORKTOP	€	FOR WORKTOPS WITH BOWL	€	PASSTHROUGH	€	PASSTHROUGH-WITHOUT WORKTOP	€
	TMWHD-6		TMCHD-6		TMHD-6 SE		TMHD-6 OB SE		TMCHDP-6		TMHDP-6 SE	
400x600x850	19094497	-	19094501	-	19094505	-	-	-	19094527	-	19094531	-
600x600x850	19094498	-	19094502	-	19094506	-	19094509	-	19094528	-	19094532	-
800x600x850	19094499	-	19094503	-	19094507	-	19094510	-	19094529	-	19094533	-
1000x600x850	19094500	-	19094504	-	19094508	-	19094511	-	19094530	-	19094534	-

### 700 Range

DIMENSIONS (mm)	WALL-MOUNTED	€	CENTRAL	€	WITHOUT WORKTOP	€	FOR WORKTOPS WITH BOWL	€	PASSTHROUGH	€	PASSTHROUGH-WITHOUT WORKTOP	€
	TMWHD-7		TMCHD-7		TMHD-7 SE		TMHD-7 OB SE		TMCHDP-7		TMHDP-7 SE	
400x700x850	19094512	-	19094516	-	19094520	-	-	-	19094535	-	19094539	-
600x700x850	19094513	-	19094517	-	19094521	-	19094524	-	19094536	-	19094540	-
800x700x850	19094514	-	19094518	-	19094522	-	19094525	-	19094537	-	19094541	-
1000x700x850	19094515	-	19094519	-	19094523	-	19094526	-	19094538	-	19094542	-

## Elements with drawers or hopper



TMWDR3-64



TMWDR1-66



TMWWH-66



See options

- Worktop made from AISI-304 18/10 stainless steel with satin finish.
- Backsplash of 100 x 15 mm and 50 mm front edge with welded corners.
- Modular element with closed structure made from stainless steel, fully integrable with the rest of neutral and hot elements, through a common or independent worktop.
- Lower base reinforced with profile to guarantee greater robustness.
- 850 mm height elements with stainless steel height-adjustable feet (-10 mm / + 50 mm)..
- **Supplied assembled.**

### Element with 3 drawers

- Module with three (3) drawers.
- Removable drawers with telescopic sliding guides.
- Effective dimensions of the drawer 304 x 435 x 105 mm.



RANGE	DIMENSIONS (mm)	MODEL	WALL-MOUNTED	€	MODEL	CENTRAL	€	MODEL	WITHOUT WORKTOP	€
600	400x600x850	TMWDR3-64	19094485	-	TMCDR3-64	19094486	-	TMDR3-64 SE	19094487	-
700	400x700x850	TMWDR3-74	19094488	-	TMCDR3-74	19094489	-	TMDR3-74 SE	19094490	-

### Element with large capacity drawer

- Specially designed to be used as a bread dispenser, to place waste bags or other applications.
- Removable drawer equipped with telescopic guides with brake.



RANGE	DIMENSIONS (mm)	MODEL	WALL-MOUNTED	€	MODEL	CENTRAL	€	MODEL	WITHOUT WORKTOP	€
600	600x600x850	TMWDR1-66	19094491	-	TMCDR1-66	19094492	-	TMDR1-66 SE	19094493	-
700	600x700x850	TMWDR1-76	19094494	-	TMCDR1-76	19094495	-	TMDR1-76 SE	19094496	-

### Elements with hopper

- Specially designed to be used as a bread dispenser, to place waste bags or other applications.
- Opening with folding lid.



RANGE	DIMENSIONS (mm)	MODEL	WALL-MOUNTED	€	MODEL	CENTRAL	€	MODEL	WITHOUT WORKTOP	€
600	600x600x850	TMWWH-66	19106416	-	TMCWH-66	19106418	-	TMWH-66 SE	19106421	-
700	600x700x850	TMWWH-76	19106417	-	TMCWH-76	19106420	-	TMWH-76 SE	19106422	-

# Elements with sliding doors and drawers



TMWDDR3R-614



TMWDDR3L-614

Option customization in length



See options

- Worktop made from AISI-304 18/10 stainless steel with satin finish.
- Backsplash of 100 x 15 mm and 50 mm front edge with welded corners.
- Modular element with closed structure made from stainless steel, fully integrable with the rest of neutral and hot elements, through a common or independent worktop.
- Lower base reinforced with profile to guarantee greater robustness.
- 850 mm height elements with stainless steel height-adjustable feet (-10 mm / + 50 mm).

- Intermediate shelf made from stainless steel, adjustable in height and reinforced with profiles.
- Module with three (3) drawers included.
- Removable drawers with telescopic sliding guides.
- Effective dimensions of the drawer 304 x 435 x 105 mm.
- **Supplied assembled.**
- **Option door lock.**



## Drawers at the right

### 600 Range



DIMENSIONS (mm)	WALL-MOUNTED	€	CENTRAL	€	WITHOUT WORKTOP	€
	TMWDDR3R-6		TMDDR3R-6		TMDDR3R-6 SE	
1400x600x850	19094579	-	19094585	-	19094591	-
1600x600x850	19094580	-	19094586	-	19094592	-
1800x600x850	19094581	-	19094587	-	19094593	-
2000x600x850	19094582	-	19094588	-	19094594	-
2200x600x850	19094583	-	19094589	-	19094595	-
2400x600x850	19094584	-	19094590	-	19094596	-

### 700 Range

DIMENSIONS (mm)	WALL-MOUNTED	€	CENTRAL	€	WITHOUT WORKTOP	€
	TMWDDR3R-7		TMDDR3R-7		TMDDR3R-7 SE	
1400x700x850	19094597	-	19094603	-	19094609	-
1600x700x850	19094598	-	19094604	-	19094610	-
1800x700x850	19094599	-	19094605	-	19094611	-
2000x700x850	19094600	-	19094606	-	19094612	-
2200x700x850	19094601	-	19094607	-	19094613	-
2400x700x850	19094602	-	19094608	-	19094614	-

## Drawers at the left

### 600 Range



DIMENSIONS (mm)	WALL-MOUNTED	€	CENTRAL	€	WITHOUT WORKTOP	€
	TMWDDR3L-6		TMDDR3L-6		TMDDR3L-6 SE	
1400x600x850	19094543	-	19094549	-	19094555	-
1600x600x850	19094544	-	19094550	-	19094556	-
1800x600x850	19094545	-	19094551	-	19094557	-
2000x600x850	19094546	-	19094552	-	19094558	-
2200x600x850	19094547	-	19094553	-	19094559	-
2400x600x850	19094548	-	19094554	-	19094560	-

### 700 Range

DIMENSIONS (mm)	WALL-MOUNTED	€	CENTRAL	€	WITHOUT WORKTOP	€
	TMWDDR3L-7		TMDDR3L-7		TMDDR3L-7 SE	
1400x700x850	19094561	-	19094567	-	19094573	-
1600x700x850	19094562	-	19094568	-	19094574	-
1800x700x850	19094563	-	19094569	-	19094575	-
2000x700x850	19094564	-	19094570	-	19094576	-
2200x700x850	19094565	-	19094571	-	19094577	-
2400x700x850	19094566	-	19094572	-	19094578	-

# Hot elements



TMWH-614



See options

- Worktop made from AISI-304 18/10 stainless steel with satin finish.
- Backsplash of 100 x 15 mm and 50 mm front edge with welded corners.
- Modular element with closed structure made from stainless steel, fully integrable with the rest of neutral elements, through a common or independent worktop.
- Lower base reinforced with profile to guarantee greater robustness.
- 850 mm height elements with stainless steel height-adjustable feet (-10 mm / + 50 mm).
- Forced hot air distribution system. Resistor-fan system enables a fast heating up and produces an efficient air circulation inside.
- Wool rock insulation.
- Electronic thermostat, with digital display, to control and regulate the temperature at desired set point.
- Working temperature: from +30 °C to +90 °C.
- **Supplied assembled.**
- **Option door lock.**

## 600 Range



DIMENSIONS (mm)	Hz	VOLTAGE	POWER (W)	WALL-MOUNTED TMWH-6	€	CENTRAL TMCH-6	€	WITHOUT WORKTOP TMH-6 SE	€
1200x600x850	50/60	230V 1N	1565	19094681	-	19094645	-	19094649	-
1400x600x850	50/60	230V 1N	1565	19094682	-	19094646	-	19094650	-
1600x600x850	50/60	230V 1N	2600	19094683	-	19094647	-	19094651	-
1800x600x850	50/60	230V 1N	2600	19094684	-	19094648	-	19094652	-

DIMENSIONS (mm)	Hz	VOLTAGE	POWER (W)	PASSTHROUGH TMPH-6	€	PASSTHROUGH WITHOUT WORKTOP TMPH-6 SE	€
1200x600x850	50/60	230V 1N	1565	19094663	-	19094667	-
1400x600x850	50/60	230V 1N	2600	19094664	-	19094668	-
1600x600x850	50/60	230V 1N	2600	19094665	-	19094669	-
1800x600x850	50/60	230V 1N	3000	19094666	-	19094670	-

## 700 Range



DIMENSIONS (mm)	Hz	VOLTAGE	POWER (W)	WALL-MOUNTED TMWH-7	€	CENTRAL TMCH-7	€	WITHOUT WORKTOP TMH-7 SE	€
1200x700x850	50/60	230V 1N	1565	19094685	-	19094653	-	19094658	-
1400x700x850	50/60	230V 1N	1565	19094686	-	19094654	-	19094659	-
1600x700x850	50/60	230V 1N	2600	19094687	-	19094655	-	19094660	-
1800x700x850	50/60	230V 1N	2600	19094688	-	19094656	-	19094661	-
2000x700x850	50/60	230V 1N	3000	19094689	-	19094657	-	19094662	-

DIMENSIONS (mm)	Hz	VOLTAGE	POWER (W)	PASSTHROUGH TMPH-7	€	PASSTHROUGH WITHOUT WORKTOP TMPH-7 SE	€
1200x700x850	50/60	230V 1N	2600	19094671	-	19094676	-
1400x700x850	50/60	230V 1N	2600	19094672	-	19094677	-
1600x700x850	50/60	230V 1N	2600	19094673	-	19094678	-
1800x700x850	50/60	230V 1N	3000	19094674	-	19094679	-
2000x700x850	50/60	230V 1N	3000	19094675	-	19094680	-

# Elements with rack module



TMC-78 GN



See options

- Worktop made from AISI-304 18/10 stainless steel with satin finish.
- Backsplash of 100 x 15 mm and 50 mm front edge with welded corners.
- Modular element with closed structure made from stainless steel, fully integrable with the rest of neutral and hot elements, through a common or independent worktop.
- Designed to store grids or pans.
- Lower base reinforced with profile to guarantee greater robustness.
- 850 mm height elements with stainless steel height-adjustable feet (-10 mm / + 50 mm).
- **Supplied assembled.**

## 600 Range

CAPACITY	DIMENSIONS (mm)	MODEL	WALL-MOUNTED	€	MODEL	CENTRAL	€	MODEL	WITHOUT WORKTOP	€
1xGN 1/1	400x600x850	TMW-64 GN	19094627	-	TMC-64 GN	19094629	-	TM-64 GN SE	19094631	-
2xGN 1/1	800x600x850	TMW-68 GN	19094628	-	TMC-68 GN	19094630	-	TM-68 GN SE	19094632	-

## 700 Range

CAPACITY	DIMENSIONS (mm)	MODEL	WALL-MOUNTED	€	MODEL	CENTRAL	€	MODEL	WITHOUT WORKTOP	€
1xGN 1/1	400x700x850	TMW-74 GN	19094633	-	TMC-74 GN	19094637	-	TM-74 GN SE	19094641	-
1x600x400	500x700x850	TMW-75 P	19094634	-	TMC-75 P	19094638	-	TM-75 P SE	19094642	-
2xGN 1/1	800x700x850	TMW-78 GN	19094635	-	TMC-78 GN	19094639	-	TM-78 GN SE	19094643	-
2x600x400	1000x700x850	TMW-710 P	19094636	-	TMC-710 P	19094640	-	TM-710 P SE	19094644	-



## 600 mm height elements



TM6W-612

Option customization in length



TM6WHD-68

See options

- Worktop made from AISI-304 18/10 stainless steel with satin finish.
- Backsplash of 100 x 15 mm and 50 mm front edge with welded corners.
- Modular element with closed structure made from stainless steel, fully integrable with the rest of 600 mm-height neutral elements, through a common or independent worktop.

- Lower base reinforced with profile to guarantee greater robustness.
- Designed to support cooking appliances and place the working height at 850-900 mm. With stainless steel height-adjustable feet (-10 mm / + 50 mm).
- **Supplied assembled.**
- **Option door lock (Elements with swing doors).**

### Open elements



DIMENSIONS (mm)	WALL-MOUNTED TM6W-6   TM6W-7	€	CENTRAL TM6C-6   TM6C-7	€	WITHOUT WORKTOP TM6-6 SE   TM6-7 SE	€
<b>600 RANGE</b>						
600x600x600	19094690	-	19094696	-	19094702	-
800x600x600	19094691	-	19094697	-	19094703	-
1000x600x600	19094692	-	19094698	-	19094704	-
1200x600x600	19094693	-	19094699	-	19094705	-
1400x600x600	19094694	-	19094700	-	19094706	-
1600x600x600	19094695	-	19094701	-	19094707	-
<b>700 RANGE</b>						
600x700x600	19094708	-	19094714	-	19094720	-
800x700x600	19094709	-	19094715	-	19094721	-
1000x700x600	19094710	-	19094716	-	19094722	-
1200x700x600	19094711	-	19094717	-	19094723	-
1400x700x600	19094712	-	19094718	-	19094724	-
1600x700x600	19094713	-	19094719	-	19094725	-

### Elements with swing doors



DIMENSIONS (mm)	WALL-MOUNTED TM6WHD-6   TM6WHD-7	€	CENTRAL TM6CHD-6   TM6CHD-7	€	WITHOUT WORKTOP TM6HD-6 SE   TM6HD-7 SE	€
<b>600 RANGE</b>						
400x600x600	19094726	-	19094730	-	19094734	-
600x600x600	19094727	-	19094731	-	19094735	-
800x600x600	19094728	-	19094732	-	19094736	-
1000x600x600	19094729	-	19094733	-	19094737	-
<b>700 RANGE</b>						
400x700x600	19094738	-	19094742	-	19094746	-
600x700x600	19094739	-	19094743	-	19094747	-
800x700x600	19094740	-	19094744	-	19094748	-
1000x700x600	19094741	-	19094745	-	19094749	-

## Corner elements



TM90W-6 R



See options

- Worktop made from AISI-304 18/10 stainless steel with satin finish.
- Backsplash of 100 x 15 mm and 50 mm front edge with welded corners.
- Modular element with closed structure made from stainless steel, fully integrable with the rest of neutral and hot elements, through an independent worktop.
- Designed to optimize the space in the corners while maintaining a homogeneous line next to neutral and hot elements.

- Lower base reinforced with profile to guarantee greater robustness.
- 850 mm height elements with stainless steel height-adjustable feet (-10 mm / + 50 mm).
- **Supplied assembled.**
- **Option door lock.**

### Closed corner elements

- Specially designed with a coupling module for one (1) swing door to facilitate the connection to another worktop.

- Requires worktop with 500 mm overhang on coupling module.
- Straight corners.

### 600 Range

MODEL	CODE	DIMENSIONS (mm)	POSITION	€
TM90W-6 R	19094621	1100x600x850	Right	-
TM90W-6 L	19094622	1100x600x850	Left	-

### 700 Range

MODEL	CODE	DIMENSIONS (mm)	POSITION	€
TM90W-7 R	19094623	1200x700x850	Right	-
TM90W-7 L	19094624	1200x700x850	Left	-

### Corner elements with door

#### 600 Range

MODEL	CODE	DIMENSIONS (mm)	€
TM90WD-6	19094625	1000x1000x600x850	-

#### 700 Range

MODEL	CODE	DIMENSIONS (mm)	€
TM90WD-7	19094626	1000x1000x700x850	-

## Waste collection elements

See options

- Corner elements with door
- Modular element with closed structure made from stainless steel, fully integrable with the rest of neutral and hot elements, through a common or independent worktop.
- 850 mm height elements with stainless steel height-adjustable feet (-10 mm / + 50 mm).

- Sorting hole with rubber ring to throw waste. A waste bin (not included) with maximum diameter of 360 mm could be placed under the counter.
- **Supplied assembled.**



RANGE	DIMENSIONS (mm)	MODEL	WALL-MOUNTED	€	MODEL	CENTRAL	€	MODEL	WITHOUT WORKTOP	€
600	600x600x850	TMWD-R-66	19094615	-	TMCD-R-66	19094616	-	TMD-R-66 SE	19094617	-
700	600x700x850	TMWD-R-76	19094618	-	TMCD-R-76	19094619	-	TMD-R-76 SE	19094620	-

# Elements with sink



See options

- Modular element with closed structure made from stainless steel, fully integrable with the rest of neutral elements, through an independent worktop.
- Lower base reinforced with profile to guarantee greater robustness.
- 850 mm height elements with stainless steel height-adjustable feet (-10 mm / + 50 mm).
- Worktop fully made from AISI-304 18/10 stainless steel, 1 mm thickness and overflow rim.

- Single-pressed, sound-proof bowls.
- Drain valve and overflow pipe for each bowl.
- Backsplash of 100 x 15 mm and 50 mm front edge with welded corners.
- **Supplied assembled.**
- **Option door lock.**



## 600 Range

MODEL	DIMENSIONS (mm)	BOWL DIMENSIONS (mm)	ELEMENTS WITH DOORS		DOOR TYPE	€	ELEMENTS WITH DOORS AND SPACE FOR UNDERCOUNTER DISHWASHER		DOOR TYPE	€
			D	WD			D	WD		
SKM-66	600x600	B1	500x400x250	19094750	Swing	-	-	-	-	-
SKM-610	1000x600	B1 D1R	400x400x250	19094751	Sliding	-	-	-	-	-
		B1 D1L	400x400x250	19094752	Sliding	-	-	-	-	-
		B2	400x400x250	19094753	Sliding	-	-	-	-	-
SKM-612	1200x600	B1 D1R	500x400x250	19094754	Sliding	-	19094766	Swing	-	-
		B1 D1L	500x400x250	19094755	Sliding	-	19094767	Swing	-	-
		B2	500x400x250	19094756	Sliding	-	-	-	-	-
SKM-614	1400x600	B2 D1R	400x400x250	19094757	Sliding	-	-	-	-	-
		B2 D1L	400x400x250	19094758	Sliding	-	-	-	-	-
		B1 D1R	500x400x250	19094759	Sliding	-	19094768	Swing	-	-
		B1 D1L	500x400x250	19094760	Sliding	-	19094769	Swing	-	-
SKM-616	1600x600	B2 D1R	500x400x250	19094761	Sliding	-	-	-	-	-
		B2 D1L	500x400x250	19094762	Sliding	-	-	-	-	-
SKM-618	1800x600	B2 D1R	500x400x250	19094763	Sliding	-	19094770	Sliding	-	-
		B2 D1L	500x400x250	19094764	Sliding	-	19094771	Sliding	-	-
SKM-620	2000x600	B2 D2RL	500x400x250	19094765	Sliding	-	-	-	-	-



## 700 Range

MODEL	DIMENSIONS (mm)	BOWL DIMENSIONS (mm)	ELEMENTS WITH DOORS		DOOR TYPE	€	WITH DOORS AND SPACE COUNTER DISHWASHER		DOOR TYPE	€
			D	WD			D	WD		
SKM-77	700x700	B1	500x500x300	19094772	Swing	-	-	-	-	-
SKM-710	1000x700	B1 D1R	400x500x300	19094773	Sliding	-	-	-	-	-
		B1 D1L	400x500x300	19094774	Sliding	-	-	-	-	-
		B2	400x500x300	19094775	Sliding	-	-	-	-	-
SKM-712	1200x700	B1 D1R	500x500x300	19094776	Sliding	-	19094789	Swing	-	-
		B1 D1L	500x500x300	19094777	Sliding	-	19094790	Swing	-	-
		B2	500x500x300	19094778	Sliding	-	-	-	-	-
SKM-714	1400x700	B1 D1R	600x500x300	19094779	Sliding	-	19094791	Swing	-	-
		B1 D1L	600x500x300	19094780	Sliding	-	19094792	Swing	-	-
SKM-716	1600x700	B2	600x500x300	19094781	Sliding	-	-	-	-	-
		B2 D1R	500x500x300	19094782	Sliding	-	-	-	-	-
SKM-718	1800x700	B2 D1L	500x500x300	19094783	Sliding	-	-	-	-	-
		B2 D1R	500x500x300	19094784	Sliding	-	19094793	Sliding	-	-
SKM-720	2000x700	B2 D1L	500x500x300	19094785	Sliding	-	19094794	Sliding	-	-
		B3	500x500x300	19094786	Sliding	-	-	-	-	-
SKM-720	2000x700	B2 D1R	600x500x300	19094787	Sliding	-	-	-	-	-
		B2 D1L	600x500x300	19094788	Sliding	-	-	-	-	-

# Worktops

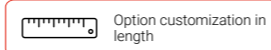

- Worktop made from AISI-304 18/10 stainless steel with satin finish.
- Backsplash of 100 x 15 mm and 50 mm front edge with

- welded corners.
- Designed to be mounted on neutral and hot element compositions without worktop.



See options

## Flat worktops

### 600 Range



DIMENSIONS (mm)	WALL-MOUNTED MTTW-6	€	CENTRAL MTTC-6	€
600x600	19094903	-	19094880	-
700x600	19094904	-	19094881	-
800x600	19094905	-	19094882	-
900x600	19094906	-	19094883	-
1000x600	19094907	-	19094884	-
1100x600	19094908	-	19094885	-
1200x600	19094909	-	19094886	-
1300x600	19094910	-	19094887	-
1400x600	19094911	-	19094888	-
1500x600	19094912	-	19094889	-
1600x600	19094913	-	19094890	-
1700x600	19094914	-	19094891	-
1800x600	19094915	-	19094892	-
1900x600	19094916	-	19094893	-
2000x600	19094917	-	19094894	-
2100x600	19094918	-	19094895	-
2200x600	19094919	-	19094896	-
2300x600	19094920	-	19094897	-
2400x600	19094921	-	19094898	-
2500x600	19094922	-	19094899	-
2600x600	19094923	-	19094900	-
2700x600	19094924	-	19094901	-
2800x600	19094925	-	19094902	-

### 700 Range



DIMENSIONS (mm)	WALL-MOUNTED MTTW-7	€	CENTRAL MTTC-7	€
600x700	19094949	-	19094926	-
700x700	19094950	-	19094927	-
800x700	19094951	-	19094928	-
900x700	19094952	-	19094929	-
1000x700	19094953	-	19094930	-
1100x700	19094954	-	19094931	-
1200x700	19094955	-	19094932	-
1300x700	19094956	-	19094933	-
1400x700	19094957	-	19094934	-
1500x700	19094958	-	19094935	-
1600x700	19094959	-	19094936	-
1700x700	19094960	-	19094937	-
1800x700	19094961	-	19094938	-
1900x700	19094962	-	19094939	-
2000x700	19094963	-	19094940	-
2100x700	19094964	-	19094941	-
2200x700	19094965	-	19094942	-
2300x700	19094966	-	19094943	-
2400x700	19094967	-	19094944	-
2500x700	19094968	-	19094945	-
2600x700	19094969	-	19094946	-
2700x700	19094970	-	19094947	-
2800x700	19094971	-	19094948	-

## Double central flat worktop



### 1200 Range

MODEL	CODE	DIMENSIONS (mm)	€
MTTC-1214	19094795	1400x1200	-
MTTC-1216	19094796	1600x1200	-
MTTC-1218	19094797	1800x1200	-
MTTC-1220	19094798	2000x1200	-
MTTC-1222	19094799	2200x1200	-
MTTC-1224	19094800	2400x1200	-
MTTC-1226	19094801	2600x1200	-
MTTC-1228	19094802	2800x1200	-

### 1300 Range

MODEL	CODE	DIMENSIONS (mm)	€
MTTC-1314	19094803	1400x1300	-
MTTC-1316	19094804	1600x1300	-
MTTC-1318	19094805	1800x1300	-
MTTC-1320	19094806	2000x1300	-
MTTC-1322	19094807	2200x1300	-
MTTC-1324	19094808	2400x1300	-
MTTC-1326	19094809	2600x1300	-
MTTC-1328	19094810	2800x1300	-

## Worktops with bowl

- Welded bowl of 500 x 400 x 250 mm.

### 600 Range



DIMENSIONS (mm)	BOWL TO THE RIGHT MTTW-B1R-6	€	BOWL TO THE LEFT MTTW-B1L-6	€	BOWL IN CENTER MTTW-B1C-6	€
1000x600	19094972	-	19094983	-	19094994	-
1200x600	19094973	-	19094984	-	19094995	-
1400x600	19094974	-	19094985	-	19094996	-
1500x600	19094975	-	19094986	-	19094997	-
1600x600	19094976	-	19094987	-	19094998	-
1800x600	19094977	-	19094988	-	19094999	-
2000x600	19094978	-	19094989	-	19095000	-
2200x600	19094979	-	19094990	-	19095001	-
2400x600	19094980	-	19094991	-	19095002	-
2600x600	19094981	-	19094992	-	19095003	-
2800x600	19094982	-	19094993	-	19095004	-

### 700 Range

DIMENSIONS (mm)	BOWL TO THE RIGHT MTTW-B1R-7	€	BOWL TO THE LEFT MTTW-B1L-7	€	BOWL IN CENTER MTTW-B1C-7	€
1000x700	19095005	-	19095016	-	19095027	-
1200x700	19095006	-	19095017	-	19095028	-
1400x700	19095007	-	19095018	-	19095029	-
1500x700	19095008	-	19095019	-	19095030	-
1600x700	19095009	-	19095020	-	19095031	-
1800x700	19095010	-	19095021	-	19095032	-
2000x700	19095011	-	19095022	-	19095033	-
2200x700	19095012	-	19095023	-	19095034	-
2400x700	19095013	-	19095024	-	19095035	-
2600x700	19095014	-	19095025	-	19095036	-
2800x700	19095015	-	19095026	-	19095037	-

## Reinforced profile refrigerated tables

- Made from stainless steel.
- To be installed on refrigerated tables without countertop for alignment

in modular compositions.

MODEL	CODE	APPLIES TO	€
R-ACP	19095383	GN ACP refrigerated counters	-
R-CCP-G	19095384	GN CCP refrigerated counters	-
R-CCP-S	19095385	Snack CCP refrigerated counters	-

FOR REFRIGERATED COUNTERS LENGTH (mm)	QUANTITY
<2000	3
>=2000	4

## Recycling station elements



See options

- Worktop made from AISI-304 18/10 stainless steel with satin finish.
- Backsplash of 100 x 15 mm and 50 mm front edge with welded corners.
- Element with closed structure made from stainless steel.
- 850 mm height elements with stainless steel height-adjustable feet (-10 mm / + 50 mm).

- Designed for the classification and collection of waste.
- Ø195 mm holes for placing rubber rings.
- Rubber ring (not included) to throw waste. A waste bin (not included) with maximum diameter of 360 mm could be placed under the counter.
- **Supplied assembled.**



### Mural

MODEL	CODE	DIMENSIONS (mm)	HOLES	€
<b>ADULTS</b>				
TMW-R-612	19094813	1200x600x850	2	-
TMW-R-618	19094814	1800x600x850	3	-
<b>KIDS</b>  kids				
TMW-R-K-612	19094817	1200x600x700	2	-
TMW-R-K-618	19094818	1800x600x700	3	-

### Central

MODEL	CODE	DIMENSIONS (mm)	HOLES	€
<b>ADULTS</b>				
TMC-R-612	19094811	1200x600x850	2	-
TMC-R-618	19094812	1800x600x850	3	-
<b>KIDS</b>  kids				
TMC-R-K-612	19094815	1200x600x700	2	-
TMC-R-K-618	19094816	1800x600x700	3	-



### Rubber ring

- Removable internal Ø162 mm rubber ring that facilitates the identification of the container.
- Easy to clean and disinfect.

MODEL	CODE	COLOR	€
R-Y232	19092787	Yellow	-
R-B232	19092788	Blue	-
R-R232	19092789	Red	-
R-G232	19092790	Green	-

## Accessories

### Sorting hole lid

- Specially designed to be placed on the sorting hole to cover it.



MODEL	CODE	€
RL-232	19092820	-

### Castors kit

- Ø125 mm castors.



MODEL	CODE	No. CASTORS	TABLE LENGTH	€
CMK-4	19092830	4	<= 2000 mm	-
CMK-5	19092831	5	Closed corner elements	-
CMK-6	19092832	6	> 2000 mm	-

### Plinths

- Made from stainless steel and easy assembling.

### For modular neutral and hot elements



MODEL	CODE	DIMENSIONS (mm)	€
PF-4	19094819	400	-
PF-5	19094820	500	-
PF-6	19094821	600	-
PF-8	19094822	800	-
PF-10	19094823	1000	-
PF-12	19094824	1200	-
PF-14	19094825	1400	-
PF-16	19094826	1600	-
PF-18	19094827	1800	-
PF-20	19094828	2000	-
PF-22	19092779	2200	-
PF-24	19095040	2400	-
SF-6	19092843	600 mm side	-
SF-7	19092844	700 mm side	-
PF-90WD	19095380	Closed corner elements	-
PF-90W	19095381	Corner elements with door - right or left worktop	-

### For refrigerated counters Concept

MODEL	CODE	APPLIES TO	€
PF-CC-2G	19092833	Concept GN 2-door refrigerated counters	-
PF-CC-3G	19092834	Concept GN 3-door refrigerated counters	-
PF-CC-4G	19092835	Concept GN 4-door refrigerated counters	-
PF-CC-2G R	19092836	Concept GN 2-door remote refrigerated counters	-
PF-CC-3G R	19092837	Concept GN 3-door remote refrigerated counters	-
PF-CC-4G R	19092838	Concept GN 4-door remote refrigerated counters	-
PF-CC-2S	19107247	Concept Snack 2-door refrigerated counters	-
PF-CC-3S	19092839	Concept Snack 3-door refrigerated counters	-
PF-CC-4S	19092840	Concept Snack 4-door refrigerated counters	-
PF-CC-2S R	19092841	Concept Snack 2-door remote refrigerated counters	-
PF-CC-3S R	19092842	Concept Snack 3-door remote refrigerated counters	-
PF-CC-4S R	19107248	Concept Snack 4-door remote refrigerated counters	-
SF-G	19107249	Side plinth for Concept GN refrigerated counters	-
SF-S	19107251	Side plinth for Concept Snack refrigerated counters	-

### For refrigerated counters Advance

MODEL	CODE	APPLIES TO	€
PF-AC-2G	19095562	Advance GN 2-door refrigerated counters	-
PF-AC-3G	19095563	Advance GN 3-door refrigerated counters	-
PF-AC-4G	19095564	Advance GN 4-door refrigerated counters	-
SF-A	19107252	Side plinth for Advance GN refrigerated counters	-



# Options

## Option customization in length



Indicate the code and price of the next higher model and the desired length.

## Option 1.5 mm thickness worktop.

ABBREVIATION	CODE	DIMENSIONS (mm)	€
1,5	0204-0001	Up to 1200 mm	-
1,5	0204-0002	Up to 2000 mm	-
1,5	0204-0003	Up to 2800 mm	-

## Option stainless steel reinforcements with profile.

DIMENSIONS (mm)	ABBREVIATION	WORKTOPS	€	ABBREVIATION	ONE (1) SHELF	€	ABBREVIATION	WORKTOP AND ONE (1) SHELF	€	ABBREVIATION	WORKTOP AND TWO (2) SHELVES	€
Up to 1200 mm	ST	0205-0001	-	SS	0205-0006	-	STS	0205-0011	-	ST2S	0205-0016	-
Up to 1600 mm	ST	0205-0002	-	SS	0205-0007	-	STS	0205-0012	-	ST2S	0205-0017	-
Up to 2000 mm	ST	0205-0003	-	SS	0205-0008	-	STS	0205-0013	-	ST2S	0205-0018	-
Up to 2400 mm	ST	0205-0004	-	SS	0205-0009	-	STS	0205-0014	-	ST2S	0205-0019	-

## Option door lock.

ABBREVIATION	CODE	DESCRIPTION	€
CR	0206-0001	One (1) lock	-
CR	0206-0002	Two (2) locks	-
CR	0206-0004	Four (4) locks	-

## Option side splash folded and welded to the worktop.

ABBREVIATION	CODE	SIDE	€
SPR	0207-0001	Right	-
SPL	0207-0002	Left	-
SPRL	0207-0003 *	Right + Left	-

\* Maximum length up to 2600 mm.

## Option faucet hole Ø 33 mm.

ABBREVIATION	CODE	DESCRIPTION	€
33R1	0208-0001	One (1) hole to the right	-
33L1	0208-0002	One (1) hole to the left	-
33C1	0208-0003	One (1) hole centered	-
33B1	0208-0004	One (1) hole between two (2) bowls	-
33R2	0208-0005	Two (2) holes to the right	-
33L2	0208-0006	Two (2) holes to the left	-
33C2	0208-0007	Two (2) holes centered	-
33B2	0208-0008	Two (2) holes between three (3) bowls	-
33R3	0208-0009	Three (3) holes to the right	-
33L3	0208-0010	Three (3) holes to the left	-
33C3	0208-0011	Three (3) holes centered	-

## Option one (1) sorting hole with black rubber ring on the worktop to throw waste.

ABBREVIATION	CODE	DESCRIPTION	€
RC	0209-0003	One (1) hole with ring centered	-
R	0209-0006	One (1) custom hole with ring	-

# Composition examples

Wall-mounted corner composition with integrated refrigerated counter:



No	MODEL	CODE	DESCRIPTION	DIMENSIONS (mm)	QUANTITY
1	MTTW-726	19094969	Wall-mounted flat worktop	2600x700	1
2	TMDR3-74 SE	19094490	Element with 3 drawers without worktop	400x700x850	1
3	TMHD-76 SE	19094521	Elements with swing doors without worktop	600x700x850	1
4	TM-74 GN SE	19094641	Element with rack module 1xGN1/1 without worktop	400x700x850	1
5	TMS1-712 SE	19094406	Element with shelves without worktop	1200x700x850	1
6	TM90WD-7	19094626	Corner element with door	1000x1000x700x850	1
7	MTTW-B1R-724	19095013	Worktop with bowl to the right	2400x700	1
		-	L = 2342 mm		
	33C1	0208-0003	One (1) centered faucet hole Ø 33 mm		
8	CCP-2G NT	19089829	Concept GN 2-door refrigerated counters without worktop	1342x700x850	1
9	R-CCP-G	19095384	Reinforcement with profiles for Concept refrigerated counters	-	3
10	TMHD-710 OB SE	19094526	Elements with swing doors for worktops with bowl	1000x700x850	1

Double central composition with integrated hot element:



No	MODEL	CODE	DESCRIPTION	DIMENSIONS (mm)	QUANTITY
1	MTTC-1326	19094809	Double central flat worktop	2600x1300	1
2	TMS1-68 SE	19094374	Element with shelves without worktop	800x600x850	1
3	TMD-612 SE	19094450	Elements with sliding doors without worktop	1200x600x850	1
4	TMDR1-66 SE	19094493	Element with large capacity drawer without worktop	600x600x850	1
5	TMHD-74 SE	19094520	Elements with swing doors without worktop	400x700x850	1
6	TM-710 P SE	19094644	Element with rack module 2x600x400 without worktop	1000x700x850	1
7	TMH-712 SE	19094658	Hot element without worktop	1200x700x850	1
8	PF-8	19094822	Plinth	800	1
9	PF-12	19094824	Plinth	1200	2
10	PF-6	19094821	Plinth	600	1
11	PF-4	19094819	Plinth	400	1
12	PF-10	19094823	Plinth	1000	1
13	SF-6	19092843	Side plinth	600	2
14	SF-7	19092844	Side plinth	700	2

Wall-mounted corner composition with integrated hot element:



No	MODEL	CODE	DESCRIPTION	DIMENSIONS (mm)	QUANTITY
1	MTTW-723	19094966	Wall-mounted flat worktop	2300x700x850	1
	R	0209-0006	One (1) custom hole		1
2	TMD-712 SE	19094474	Elements with sliding doors without worktop	1200x700x850	1
3	TMD-R-76 SE	19094620	Waste collection elements without worktop	600x700x850	1
4	TM90W-7 R	19094623	Closed corner elements - right worktop	1200x700x850	1
5	TMWH-720	19094689	Hot element	2000x700x850	1

# Bar elements

Coffee back bar counters	<b>493</b>
— Coffee back bar counters.....	<b>493</b>
— Back bar counters.....	<b>493</b>
Cocktail stations.....	<b>494</b>
— Accessories .....	<b>496</b>
Options .....	<b>496</b>

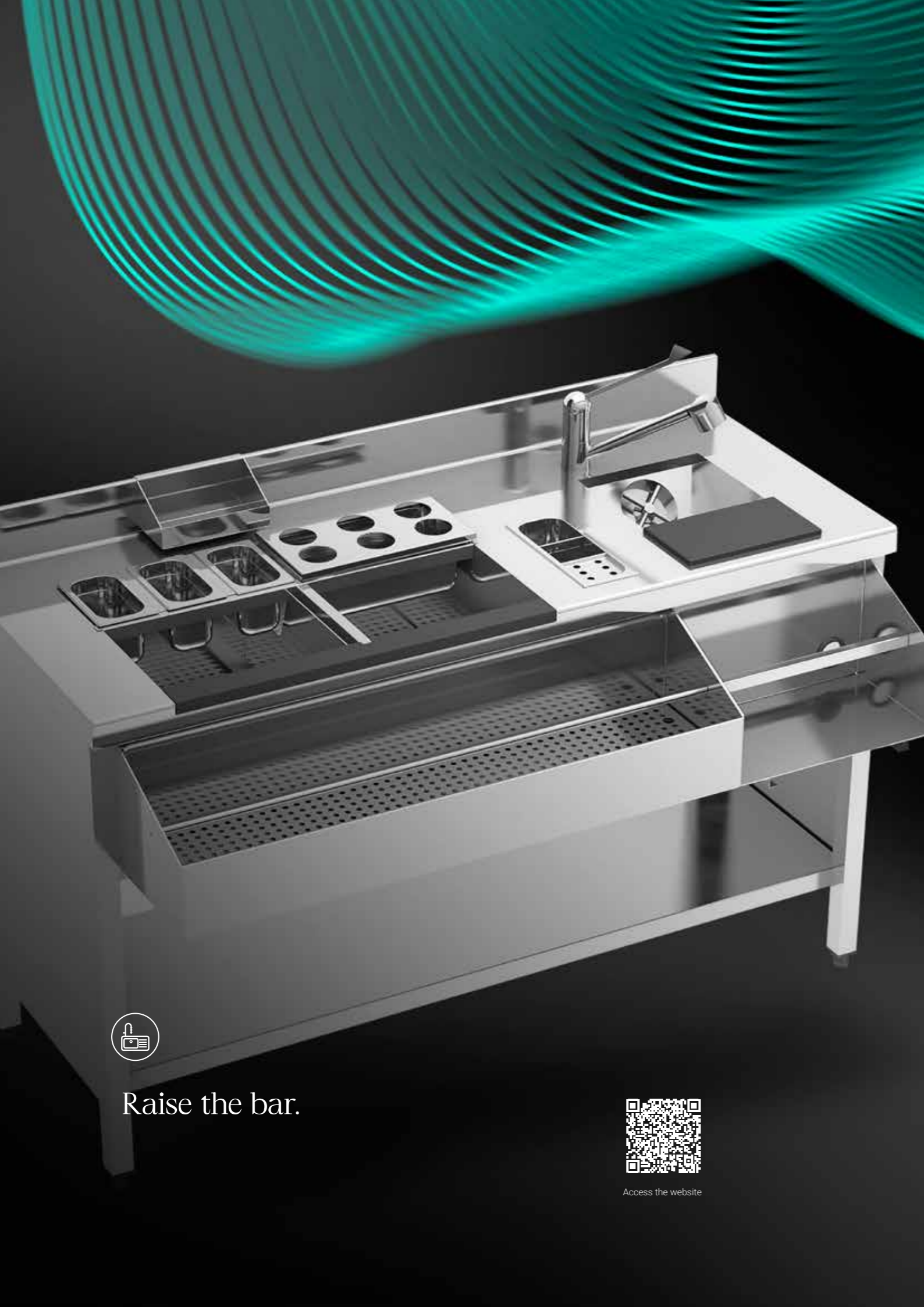

Raise the bar.



Access the website

## Coffee back bar counters



TFS1-615 WH



See options

- Specially designed to place a coffee machine. Ideal for coffee shops, bars or restaurants.
- To be complemented with back and refrigerated counters, to set up a bar line adapted to each space and need.
- Removable drawers with telescopic sliding guides.
- Waste hopper to collect coffee grounds, with a rubber stopper that absorbs noise when using.
- Back in stainless steel, partially open for coffee machine installation.
- Worktop made from AISI-304 18/10 stainless steel with satin finish and reinforced with profiles.
- Backsplash of 100 x 15 mm, 50 mm front edge with welded corners.
- **Supplied assembled.**

DIMENSIONS (mm)	HOPPER POSITION	MODEL	NO HOLE ON WORKTOP	€	MODEL	WITH HOLE ON WORKTOP	€	MODEL	WITHOUT WORKTOP	€
1000x600x1050	Right	TFS1-610 R	19094266	-	TFS1-610 R WH	19094267	-	TFS1-610 R SE	19094268	-
1000x600x1050	Left	TFS1-610 L	19094269	-	TFS1-610 L WH	19094270	-	TFS1-610 L SE	19094271	-
1500x600x1050	Center	TFS1-615	19094272	-	TFS1-615 WH	19094273	-	TFS1-615 SE	19094274	-
2000x600x1050	Center	TFS1-620	19094275	-	TFS1-620 WH	19094276	-	TFS1-620 SE	19094277	-
2500x600x1050	Center	TFS1-625	19094278	-	TFS1-625 WH	19094279	-	TFS1-625 SE	19094280	-

## Back bar counters

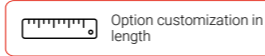

Option customization in length

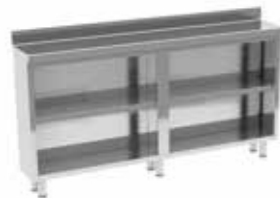

TBBS1-315



See options

- Specially designed to store small machinery, kitchenware, bar accessories, etc. Ideal for coffee shops, bars or restaurants.
- To be complemented with coffee and refrigerated back counters, to set up a bar line adapted to each space and need.
- Worktop made from AISI-304 18/10 stainless steel with satin finish and reinforced with profiles.
- Backsplash of 100 x 15 mm, 50 mm front edge with welded corners.
- **Supplied assembled.**

### 350 Range

DIMENSIONS (mm)	WITH ONE (1) SHELF		WITH TWO (2) SHELVES	
	WITH WORKTOP	WITHOUT WORKTOP	WITH WORKTOP	WITHOUT WORKTOP
	TBBS1-3	TBBS1-3 SE	TBBS2-3	TBBS2-3 SE
1000x350x1050	19094281	19094285	19094289	19094293
1500x350x1050	19094282	19094286	19094290	19094294
2000x350x1050	19094283	19094287	19094291	19094295
2500x350x1050	19094284	19094288	19094292	19094296

### 600 Range

DIMENSIONS (mm)	WITH ONE (1) SHELF		WITH TWO (2) SHELVES	
	WITH WORKTOP	WITHOUT WORKTOP	WITH WORKTOP	WITHOUT WORKTOP
	TBBS1-6	TBBS1-6 SE	TBBS2-6	TBBS2-6 SE
1000x600x1050	19094297	19094301	19094305	19094309
1500x600x1050	19094298	19094302	19094306	19094310
2000x600x1050	19094299	19094303	19094307	19094311
2500x600x1050	19094300	19094304	19094308	19094312

## Single cocktail stations



CKS1-12 BR1



See options

### Table with ice well

- Worktop made from AISI-304 18/10 stainless steel with satin finish.
- Well with thermal insulation and built-in drain.
- Backsplash of 100 x 15 mm, 50 mm front edge with welded corners.
- Square section stainless steel legs 40 x 40 mm.
- Rear legs set back 40 mm for floors with sanitary radius.
- Model with reinforcement frame: three (3) crossbars, two (2) at the sides and one (1) at the rear, as lower part element reinforcement. There is the possibility of placing the crossbar in a central position.
- Model with shelf: shelf made from stainless steel with satin finish and reinforcements in profile. Shelf assembly done by fixing four (4) screws.
- 900 mm height with stainless steel height-adjustable feet (-10 mm / + 50 mm).
- **Supplied assembled.**

MODEL	CODE	DIMENSIONS (mm)	TYPE	SPEED RAIL	BLENDER HOLDER	€
CKLR-12 BR1	19094866	1200x610x900	Reinforcement frame	Single	No	-
CKS1-12 BR1	19094867	1200x610x900	With shelf	Single	No	-

### Table with ice well and sink



CKS1-S-12 BR2 BS

- Worktop made from AISI-304 18/10 stainless steel with satin finish.
- Well with thermal insulation and built-in drain.
- 275x250x150 mm sink with built-in drain.
- Single lever mixer faucet included.
- Backsplash of 100 x 15 mm, 50 mm front edge with welded corners.
- Square section stainless steel legs 40 x 40 mm.
- Rear legs set back 40 mm for floors with sanitary radius.
- Model with reinforcement frame: three (3) crossbars, two (2) at the sides and one (1) at the rear, as lower part element reinforcement. There is the possibility of placing the crossbar in a central position.
- Model with shelf: shelf made from stainless steel with satin finish and reinforcements in profile. Shelf assembly done by fixing four (4) screws.
- 900 mm height with stainless steel height-adjustable feet (-10 mm / + 50 mm).
- **Supplied assembled.**

MODEL	CODE	DIMENSIONS (mm)	TYPE	SPEED RAIL	BLENDER HOLDER	€
CKLR-S-12 BR1	19094869	1200x610x900	Reinforcement frame	Single	No	-
CKS1-S-12 BR1	19094870	1200x610x900	With shelf	Single	No	-
CKLR-S-12 BR1 BS	19107493	1200x720x900	Reinforcement frame	Single	Yes	-
CKS1-S-12 BR1 BS	19107490	1200x720x900	With shelf	Single	Yes	-
CKLR-S-12 BR2 BS	19094872	1200x720x900	Reinforcement frame	Double	Yes	-
CKS1-S-12 BR2 BS	19094871	1200x720x900	With shelf	Double	Yes	-
CKLR-S-15 BR1 BS	19107495	1500x720x900	Reinforcement frame	Single	Yes	-
CKS1-S-15 BR1 BS	19107494	1500x720x900	With shelf	Single	Yes	-
CKLR-S-15 BR2 BS	19094874	1500x720x900	Reinforcement frame	Double	Yes	-
CKS1-S-15 BR2 BS	19094873	1500x720x900	With shelf	Double	Yes	-





CKM-S-DW-15 BR2 BS

Element with ice well and sink

- Worktop made from AISI-304 18/10 stainless steel with satin finish.
- Well with thermal insulation and built-in drain.
- 275x250x150 mm sink with built-in drain.
- Single lever mixer faucet included.
- Backsplash of 100 x 15 mm, 50 mm front edge with welded corners.
- Element with closed structure made from stainless steel.
- Lower base reinforced with profile to guarantee greater robustness.
- 900 mm height with stainless steel height-adjustable feet (-10 mm / + 50 mm).
- **Supplied assembled.**

MODEL	CODE	DIMENSIONS (mm)	SPEED RAIL	BLENDER HOLDER	DIPPER WELL	€
CKM-S-DW-15 BR2 BS	19094878	1500x720x900	Double	Yes	Yes	-



CKRF-S-DW-15 BR2 BS

Element with ice well, sink and refrigerated reserve

- Worktop made from AISI-304 18/10 stainless steel with satin finish.
- Well with thermal insulation and built-in drain.
- 275x250x150 mm sink with built-in drain.
- Single lever mixer faucet included.
- Backsplash of 100 x 15 mm, 50 mm front edge with welded corners.
- Rear legs set back 40 mm for floors with sanitary radius.
- Refrigerated reserve with drawers at the bottom, designed to store bottles.
- Stainless steel removable refrigerated drawers, with telescopic sliding guides and self-closing system.
- Rod modular system allowing an optimal organization of bottles in drawers.
- High-density (40 kg/m³), CFC-free, ecological polyurethane insulation.
- Removable pull-out/push-in magnetic gasket to keep maximum hygiene and maintain the insulating properties.
- Easy-to-extract condensing unit included.
- Evaporation system of defrost water with evaporation pan.
- Electrical components in a single, easy-to-access point to enable maintenance operations.
- Stainless steel ventilation grills on the customer side.
- Forced draft evaporator.
- Electronic thermostat, with digital display, to control and regulate the temperature of the refrigerated reserve.
- Working temperature (in climate Class IV conditions): from +0 °C to +4 °C
- **Supplied assembled.**

MODEL	REFRIGERANT GAS	HZ	CODE	DIMENSIONS (mm)	SPEED RAIL	BLENDER HOLDER	DIPPER WELL	POWER (W)	€
CKRF-S-15 BR2 BS	R290	50/60	19094877	1500x720x900	Double	Yes	No	255	-
CKRF-S-DW-15 BR2 BS	R290	50/60	19094879	1500x720x900	Double	Yes	Yes	255	-

Accessories



Jigger shelf

- Specially designed to store jiggers. It can be hung from the backsplash or from the cocktail station well.

MODEL	CODE	€
SS-3	19092975	-



Bottle support

- Specially designed to store bottles inside a GN 1/3 pan (not included).

MODEL	CODE	€
SB-13	19092976	-

Options

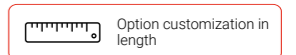

Option customization in length

Indicate the code and price of the next higher model and the desired length.

Option 1.5 mm thickness worktop.

ABBREVIATION	CODE	DIMENSIONS (mm)	€
1,5	0204-0001	Up to 1200 mm	-
1,5	0204-0002	Up to 2000 mm	-
1,5	0204-0003	Up to 2800 mm	-

Note: applies to back bar elements.

Option side splash folded and welded to the worktop.

ABBREVIATION	CODE	SIDE	€
SPR	0207-0001	Right	-
SPL	0207-0002	Left	-
SPRL	0207-0003	Right + left	-

Note: applies to back bar elements.

Option stainless steel reinforcements with profile.

DIMENSIONS (mm)	ABBREVIATION ONE (1) SHELF	CODE	€	ABBREVIATION WORKTOP AND ONE (1) SHELF	CODE	€
Up to 1200 mm	SS	0205-0006	-	STS	0205-0011	-
Up to 1600 mm	SS	0205-0007	-	STS	0205-0012	-
Up to 2000 mm	SS	0205-0008	-	STS	0205-0013	-
Up to 2800 mm	SS	0205-0010	-	STS	0205-0015	-

# Shelving

Wall-mounted shelves.....	<b>499</b>
Shelves on racks .....	<b>502</b>
Polyethylene shelves.....	<b>503</b>



Stability, strength and maximized storage space utilization.



Access the website

## Wall-mounted shelves



### Welded flat shelves

- Made from stainless steel fully welded.
- Wall brackets with drills (screws and plugs included).

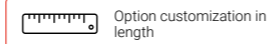

MODEL	CODE	DIMENSIONS (mm)	€
SW-26	19094831	600x250x150	-
SW-28	19094832	800x250x150	-
SW-210	19094833	1000x250x150	-
SW-212	19094834	1200x250x150	-
SW-214	19094835	1400x250x150	-
SW-215	19094836	1500x250x150	-
SW-216	19094837	1600x250x150	-
SW-218	19094838	1800x250x150	-
SW-220	19094839	2000x250x150	-
SW-46	19094840	600x400x250	-
SW-48	19094841	800x400x250	-
SW-410	19094842	1000x400x250	-
SW-412	19094843	1200x400x250	-
SW-414	19094844	1400x400x250	-
SW-415	19094845	1500x400x250	-
SW-416	19094846	1600x400x250	-
SW-418	19094847	1800x400x250	-
SW-420	19094848	2000x400x250	-

### Flat shelves with brackets

- Made from stainless steel.
- Wall brackets with drills (screws and plugs included).
- Quick and easy assembly.

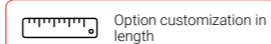

MODEL	CODE	DIMENSIONS (mm)	€
SWD-36	19094857	600x300x200	-
SWD-38	19094858	800x300x200	-
SWD-310	19094859	1000x300x200	-
SWD-312	19094860	1200x300x200	-
SWD-314	19094861	1400x300x200	-
SWD-315	19094862	1500x300x200	-
SWD-316	19094863	1600x300x200	-
SWD-318	19094864	1800x300x200	-
SWD-320	19094865	2000x300x200	-

### Dish drainer shelves



- Made from stainless steel fully welded.
- Removable stainless steel grills for easy cleaning.
- Wall brackets with drills (screws and plugs included).
- For plates with a maximum diameter of 250 mm.

MODEL	CODE	DIMENSIONS (mm)	€
SD-37	19092876	780x300x200	-
SD-314	19092877	1535x300x200	-

### Microwave shelves



- Specially designed to place a microwave oven or other small appliances.
- Made from stainless steel.
- Wall brackets with drills (screws and plugs included).
- Ø60 mm cable gland hole.
- Quick and easy assembly.
- Supplied disassembled.

MODEL	CODE	DIMENSIONS (mm)	€
SMW-46	19092882	600x400x230	-
SMW-57	19092883	700x550x280	-
SMW-48	19092884	800x400x230	-



### Extraction hood shelves

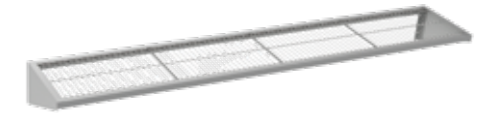

- Made from stainless steel fully welded.
- Removable GN 1/1 stainless steel grills for easy cleaning.
- Wall brackets with drills (screws and plugs included).

MODEL	CODE	DIMENSIONS (mm)	€
SH-45	19092878	595x390x200	-
SH-411	19092879	1125x390x200	-
SH-416	19092880	1655x390x200	-
SH-421	19092881	2185x390x200	-

### Tube shelves

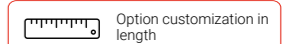

- Made from stainless steel fully welded.
- Wall brackets with drills (screws and plugs included).
- The 1800 and 2000mm long models have a welded center bracket.

MODEL	CODE	DIMENSIONS (mm)	€
SP-46	19094849	600x400x250	-
SP-48	19094850	800x400x250	-
SP-410	19094851	1000x400x250	-
SP-412	19094852	1200x400x250	-
SP-414	19094853	1400x400x250	-
SP-416	19094854	1600x400x250	-
SP-418	19094855	1800x400x250	-
SP-420	19094856	2000x400x250	-

### Dishwashing basket tilted shelves

- Made from stainless steel fully welded.
- Wall brackets with drills (screws and plugs included).
- Ø16 mm drain.

MODEL	CODE	DIMENSIONS (mm)	€
SWW-511	19092901	1100x505x231	-
SWW-516	19092902	1600x505x231	-

## Wall-mounted shelves on racks

- Made from stainless steel.



## Vertical rack

MODEL	CODE	DIMENSIONS (mm)	€/UNIT
SAS-6	19092885	600	-
SAS-10	19092886	1000	-
SAS-15	19092887	1500	-

## Flat shelf

MODEL	CODE	DIMENSIONS (mm)	€
SPF-210	19092888	1000x250	-
SPF-212	19092889	1200x250	-
SPF-214	19092890	1400x250	-
SPF-216	19092891	1600x250	-
SPF-410	19092892	1000x400	-
SPF-412	19092893	1200x400	-
SPF-414	19092894	1400x400	-
SPF-416	19092895	1600x400	-

## Tilted shelf

MODEL	CODE	DIMENSIONS (mm)	No PANS	PANS SIZE	€
SI-210	19092896	1000x250	4	GN 1/6	-
SI-410	19092897	1000x400	4	GN 1/3	-



## Hanging bar

- Made from stainless steel fully welded.  
- Ø30 mm tube.

- Welded plates with drills (screws and plugs included).

MODEL	CODE	DIMENSIONS (mm)	€
UH-10	19092898	1000x150	-
UH-15	19092899	1500x150	-
UH-20	19092900	2000x150	-

## Shelves on racks



## On racks

- Made from stainless steel.

- Height of the shelves adjustable every 150 mm.

MODEL	CODE	DIMENSIONS (mm)	€/ SET 4 FEET
SF-17	19092935	1700	-
SF-20	19092936	2000	-



## Stainless steel flat shelves

- Made from stainless steel.

- Shelves fixed to the racks using tools included.

DIMENSIONS (mm)	1 mm THICKNESS						1.5 mm THICKNESS					
	WITHOUT REINFORCEMENT		MAXIMUM LOAD (KG)/ SHELF	€	WITH REINFORCEMENT		MAXIMUM LOAD (KG)/ SHELF	€	WITHOUT REINFORCEMENT		MAXIMUM LOAD (KG)/ SHELF	€
	SS10				SS10R				SS15			
800x400	19092903	210	-	19092911	260	-	19092919	280	-	19092927	330	-
1000x400	19092904	160	-	19092912	210	-	19092920	230	-	19092928	280	-
1200x400	19092905	110	-	19092913	160	-	19092921	130	-	19092929	180	-
1400x400	19092906	85	-	19092914	135	-	19092922	105	-	19092930	155	-
800x500	19092907	205	-	19092915	255	-	19092923	280	-	19092931	330	-
1000x500	19092908	155	-	19092916	205	-	19092924	230	-	19092932	280	-
1200x500	19092909	105	-	19092917	155	-	19092925	130	-	19092933	180	-
1400x500	19092910	80	-	19092918	130	-	19092926	105	-	19092934	155	-





# Polyethylene shelves

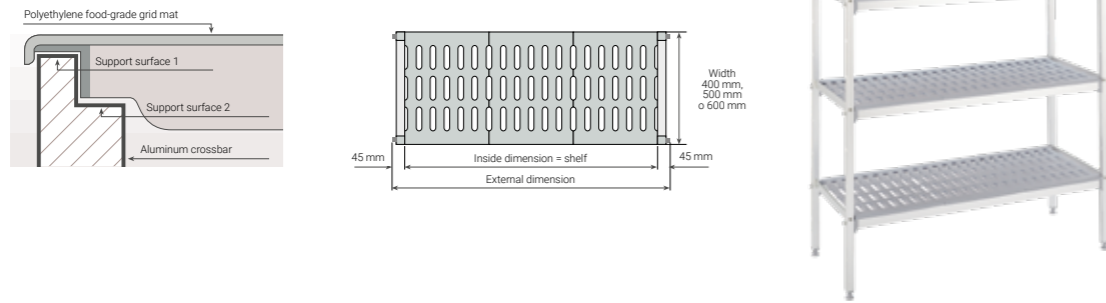

- Shelving with structure in anodized aluminum and polyethylene food-grade grid mats specially designed to be used in cold rooms.
- Polyethylene shelf plates are supported on two edges of the aluminum upright, for a perfect placement and greater solidity.
- Width options in shelf plates: 400, 500 and 600 mm.
- Standard height of uprights is 1.750 mm. 2.000 are also available for non-standard applications.

## Aluminum and polyethylene shelves



- Food-grade aluminum and polyethylene shelf specially designed to be used in cold rooms, in accordance with sanitary requirements.
- Supported on the aluminum upright by two edges,
- Grid mats and crossbars included.
- Easily removable. Can be washed in a conventional dishwasher.
- for a perfect placement and greater solidity.
- Grid mats and crossbars included.

### Width 400 mm

MODEL	CODE	DIMENSIONS (mm)	€
SA-46	19091192	600x400	-
SA-47	19091196	700x400	-
SA-48	19091197	800x400	-
SA-49	19091198	900x400	-
SA-410	19091199	1000x400	-
SA-411	19091350	1100x400	-
SA-412	19091351	1200x400	-
SA-413	19091352	1300x400	-
SA-414	19091353	1400x400	-
SA-415	19091354	1500x400	-
SA-416	19091355	1600x400	-

### Width 500 mm

MODEL	CODE	DIMENSIONS (mm)	€
SA-56	19091356	600x500	-
SA-57	19091358	700x500	-
SA-58	19091359	800x500	-
SA-59	19091360	900x500	-
SA-510	19091361	1000x500	-
SA-511	19091362	1100x500	-
SA-512	19091363	1200x500	-
SA-513	19091365	1300x500	-
SA-514	19091366	1400x500	-
SA-515	19091367	1500x500	-
SA-516	19091368	1600x500	-

### Width 600 mm

MODEL	CODE	DIMENSIONS (mm)	€
SA-66	19106115	600x600	-
SA-67	19106116	700x600	-
SA-68	19106117	800x600	-
SA-69	19106118	900x600	-
SA-610	19106119	1000x600	-
SA-611	19106160	1100x600	-
SA-612	19106161	1200x600	-
SA-613	19106162	1300x600	-
SA-614	19106163	1400x600	-
SA-615	19106164	1500x600	-
SA-616	19106165	1600x600	-

## Aluminum shelving uprights

- Made from anodized aluminum.
- Holes every 150 mm, to modify the size of standard models or increase the number of shelves
- by means of pins (4 per shelf).
- Height-adjustable feet to overcome unevenness on the floors.
- Pins included.

External dimensions of independent shelving units, including an upright on each side.



The 11 different lengths of the shelves allow, in addition to independent mounting with 2 uprights, multiple combinations by placing shelves on both sides of the uprights. See set tables.



MODEL	CODE	DIMENSIONS (mm)	LEVELS	€
<b>WIDTH 400 mm</b>				
AF17-43	19091369	1750x400	3	-
AF17-44	19091370	1750x400	4	-
AF17-45	19091371	1750x400	5	-
AF20-45	19091372	2000x400	5	-
AF20-46	19091373	2000x400	6	-
<b>WIDTH 500 mm</b>				
AF17-53	19091374	1750x500	3	-
AF17-54	19091375	1750x500	4	-
AF17-55	19091376	1750x500	5	-
AF20-55	19091377	2000x500	5	-
AF20-56	19091378	2000x500	6	-
<b>WIDTH 600 mm</b>				
AF17-63	19106166	1750x600	3	-
AF17-64	19106167	1750x600	4	-
AF17-65	19106168	1750x600	5	-
AF20-65	19106169	2000x600	5	-
AF20-66	19106170	2000x600	6	-

## Mobile shelving uprights

- Two (2) Ø125 mm stainless polyamide castors, one (1) with brake. To build a mobile shelving, apart from the shelves, two (2) mobile uprights are needed.
- Uprights included only. Shelves must be ordered separately.



MODEL	CODE	DIMENSIONS (mm)	LEVELS	€
<b>WIDTH 400 mm</b>				
KMA17-44	19091380	1750x400	4	-
KMA17-45	19091381	1750x400	5	-
<b>WIDTH 500 mm</b>				
KMA17-54	19091382	1750x500	4	-
KMA17-55	19091383	1750x500	5	-
<b>WIDTH 600 mm</b>				
KMA17-64	19106171	1750x600	4	-
KMA17-65	19106172	1750x600	5	-



### Benches

- Specially designed to store boxes in cold rooms.
- Robust stainless steel structure.

MODEL	CODE	DIMENSIONS (mm)	€
KSA2-1-510	19091391	1085x500x250	-
KSA2-1-512	19091392	1285x500x250	-
KSA2-1-516	19091393	1685x500x250	-



### Grid mats

- Food-grade polyethylene grid mat for shelves.
- Easy to install. Can be washed in a conventional dishwasher.
- Complete shelves already include grid mats. Can be supplied as accessories.

MODEL	CODE	DIMENSIONS (mm)	€
SP-43	19091384	300x400	-
SP-44	19091385	400x400	-
SP-53	19091386	300x500	-
SP-54	19091388	400x500	-
SP-63	19106173	300x600	-
SP-64	19106174	400x600	-

### Corner hooks

- Designed to make easier the assembly of corner-shaped shelving units. They also save shelving uprights and optimize the available space.
- Two (2) hooks per shelf.
- Price by unit.



MODEL	CODE	€
HK	19091389	-

### Pins

- Designed to expand the number of shelves in standard configurations.
- pins for each shelf. Four (4) pins are required per shelf.
- Supplied as an accessory, since the uprights already include
- Price by unit.



MODEL	CODE	€
AS	19091390	-

### Crossbars

- Supplied as an accessory, since they are included in each shelf.

MODEL	CODE	DIMENSIONS (mm)	€
CA-6	19091394	600	-
CA-7	19091395	700	-
CA-8	19091396	800	-
CA-9	19091397	900	-
CA-10	19091398	1000	-
CA-11	19091399	1100	-
CA-12	19091400	1200	-
CA-13	19091401	1300	-
CA-14	19091402	1400	-
CA-15	19091403	1500	-
CA-16	19091404	1600	-

## Shelving sets calculation

### How to order shelving sets

For your convenience, aluminum and polyethylene shelving can be ordered in sets. Below is an indication on how to calculate the required shelving set:

### Is it a linear or corner shaped shelving unit?

- Linear shelving have uprights at each end.
- Corner shelving units have a upright at one end and, at the other end, they are supplied with two hooks per shelf, to be supported by the crossbars of another shelving unit.

### What is the width of the shelving unit?

- There are two depth measurements: 400 or 500 mm.

### How many levels are required?

- There are standard sets with 3, 4 or 5 levels.
- Additional levels can be ordered.

### What will be the length of the shelving unit?

- In the tables on the following pages you should find the correct set for the measurements of the room where the shelving is to be placed.
- When calculating the length of the corner shelving unit, remember to subtract from the total length the depth of the shelving unit on which it will rest.

### In the following example you would have to ask:

- Set number 99 (linear, depth 400 mm, 4 levels, 1690 mm long).
- Set number 582 (angle, depth 400 mm, 4 levels, 952 mm long).

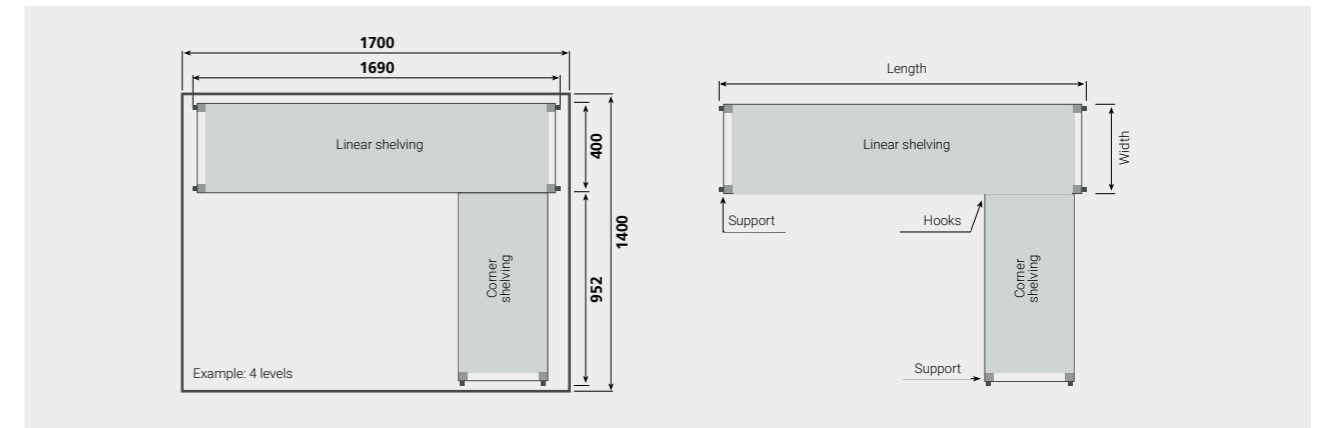

- Standard height of uprights is 1750 mm. For other heights, see the breakdown of the chosen set and replace the "AF17" uprights with "AF20" high uprights, adjusting the price of the set according to the prices of the chosen elements.

- Additional shelving levels can be added, up to a maximum total of 11 levels on standard uprights, by ordering required shelves, pins and corner hooks separately.

- Standard uprights type "AF17" can be replaced by mobile uprights "KMA17", when changing prices.

### Linear shelving 400 mm

SHELVING TOTAL LENGTH (mm)	3 LEVELS		4 LEVELS		5 LEVELS	
	SET N°	€	SET N°	€	SET N°	€
1390	17	-	96	-	175	-
1490	18	-	97	-	176	-
1590	19	-	98	-	177	-
1690	20	-	99	-	178	-
1726	21	-	100	-	179	-
1826	22	-	101	-	180	-
1926	23	-	102	-	181	-

### Corner shelving 400 mm

SHELVING TOTAL LENGTH (mm)	3 LEVELS		4 LEVELS		5 LEVELS	
	SET N°	€	SET N°	€	SET N°	€
652	500	-	579	-	658	-
752	501	-	580	-	659	-
852	502	-	581	-	660	-
952	503	-	582	-	661	-
1052	504	-	583	-	662	-
1152	505	-	584	-	663	-
1252	506	-	585	-	664	-



Linear shelving 400 mm

Linear shelving 500mm

Linear shelving 600 mm

SHELVING TOTAL LENGTH (mm)	3 LEVELS		4 LEVELS		5 LEVELS		3 LEVELS		4 LEVELS		5 LEVELS		3 LEVELS		4 LEVELS		5 LEVELS	
	SET N°	€	SET N°	€	SET N°	€	SET N°	€	SET N°	€	SET N°	€	SET N°	€	SET N°	€	SET N°	€
690	10	-	89	-	168	-	247	-	326	-	405	-	1010	-	1089	-	1168	-
790	11	-	90	-	169	-	248	-	327	-	406	-	1011	-	1090	-	1169	-
890	12	-	91	-	170	-	249	-	328	-	407	-	1012	-	1091	-	1170	-
990	13	-	92	-	171	-	250	-	329	-	408	-	1013	-	1092	-	1171	-
1090	14	-	93	-	172	-	251	-	330	-	409	-	1014	-	1093	-	1172	-
1190	15	-	94	-	173	-	252	-	331	-	410	-	1015	-	1094	-	1173	-
1290	16	-	95	-	174	-	253	-	332	-	411	-	1016	-	1095	-	1174	-
1390	17	-	96	-	175	-	254	-	333	-	412	-	1017	-	1096	-	1175	-
1490	18	-	97	-	176	-	255	-	334	-	413	-	1018	-	1097	-	1176	-
1590	19	-	98	-	177	-	256	-	335	-	414	-	1019	-	1098	-	1177	-
1690	20	-	99	-	178	-	257	-	336	-	415	-	1020	-	1099	-	1178	-
1726	21	-	100	-	179	-	258	-	337	-	416	-	1021	-	700	-	1179	-
1826	22	-	101	-	180	-	259	-	338	-	417	-	1022	-	1101	-	1180	-
1926	23	-	102	-	181	-	260	-	339	-	418	-	1023	-	1102	-	1181	-
2026	24	-	103	-	182	-	261	-	340	-	419	-	1024	-	1103	-	1182	-
2126	25	-	104	-	183	-	262	-	341	-	420	-	1025	-	1104	-	1183	-
2226	26	-	105	-	184	-	263	-	342	-	421	-	1026	-	1105	-	1184	-
2326	27	-	106	-	185	-	264	-	343	-	422	-	1027	-	1106	-	1185	-
2426	28	-	107	-	186	-	265	-	344	-	423	-	1028	-	1107	-	1186	-
2526	29	-	108	-	187	-	266	-	345	-	424	-	1029	-	1108	-	1187	-
2626	30	-	109	-	188	-	267	-	346	-	425	-	1030	-	1109	-	1188	-
2726	31	-	110	-	189	-	268	-	347	-	426	-	1031	-	1110	-	1189	-
2826	32	-	111	-	190	-	269	-	348	-	427	-	1032	-	1111	-	1190	-
2926	33	-	112	-	191	-	270	-	349	-	428	-	1033	-	1112	-	1191	-
3026	34	-	113	-	192	-	271	-	350	-	429	-	1034	-	1113	-	1192	-
3126	35	-	114	-	193	-	272	-	351	-	430	-	1035	-	1114	-	1193	-
3226	36	-	115	-	194	-	273	-	352	-	431	-	1036	-	1115	-	1194	-
3326	37	-	116	-	195	-	274	-	353	-	432	-	1037	-	1116	-	1195	-
3362	38	-	117	-	196	-	275	-	354	-	433	-	1038	-	1117	-	1196	-
3462	39	-	118	-	197	-	276	-	355	-	434	-	1039	-	1118	-	1197	-
3562	40	-	119	-	198	-	277	-	356	-	435	-	1040	-	1119	-	1198	-
3662	41	-	120	-	199	-	278	-	357	-	436	-	1041	-	1120	-	1199	-
3762	42	-	121	-	200	-	279	-	358	-	437	-	1042	-	1121	-	1200	-
3862	43	-	122	-	201	-	280	-	359	-	438	-	1043	-	1122	-	1201	-
3962	44	-	123	-	202	-	281	-	360	-	439	-	1044	-	1123	-	1202	-
4062	45	-	124	-	203	-	282	-	361	-	440	-	1045	-	1124	-	1203	-
4162	46	-	125	-	204	-	283	-	362	-	441	-	1046	-	1125	-	1204	-
4262	47	-	126	-	205	-	284	-	363	-	442	-	1047	-	1126	-	1205	-
4362	48	-	127	-	206	-	285	-	364	-	443	-	1048	-	1127	-	1206	-
4462	49	-	128	-	207	-	286	-	365	-	444	-	1049	-	1128	-	1207	-
4562	50	-	129	-	208	-	287	-	366	-	445	-	1050	-	1129	-	1208	-
4662	51	-	130	-	209	-	288	-	367	-	446	-	1051	-	1130	-	1209	-
4762	52	-	131	-	210	-	289	-	368	-	447	-	1052	-	1131	-	1210	-
4862	53	-	132	-	211	-	290	-	369	-	448	-	1053	-	1132	-	1211	-
4962	54	-	133	-	212	-	291	-	370	-	449	-	1054	-	1133	-	1212	-
4998	55	-	134	-	213	-	292	-	371	-	450	-	1055	-	1134	-	1213	-
5098	56	-	135	-	214	-	293	-	372	-	451	-	1056	-	1135	-	1214	-
5198	57	-	136	-	215	-	294	-	373	-	452	-	1057	-	1136	-	1215	-
5298	58	-	137	-	216	-	295	-	374	-	453	-	1058	-	1137	-	1216	-
5398	59	-	138	-	217	-	296	-	375	-	454	-	1059	-	1138	-	1217	-
5498	60	-	139	-	218	-	297	-	376	-	455	-	1060	-	1139	-	1218	-
5598	61	-	140	-	219	-	298	-	377	-	456	-	1061	-	1140	-	1219	-
5698	62	-	141	-	220	-	299	-	378	-	457	-	1062	-	1141	-	1220	-
5798	63	-	142	-	221	-	300	-	379	-	458	-	1063	-	1142	-	1221	-



Corner shelving 400 mm

Corner shelving 500 mm

Corner shelving 600 mm

SHELVING TOTAL LENGTH (mm)	3 LEVELS		4 LEVELS		5 LEVELS		3 LEVELS		4 LEVELS		5 LEVELS		3 LEVELS		4 LEVELS		5 LEVELS	
	SET N°	€	SET N°	€	SET N°	€	SET N°	€	SET N°	€	SET N°	€	SET N°	€	SET N°	€	SET N°	€
652	500	-	579	-	658	-	737	-	816	-	895	-	1500	-	1579	-	1658	-
752	501	-	580	-	659	-	738	-	817	-	896	-	1501	-	1580	-	1659	-
852	502	-	581	-	660	-	739	-	818	-	897	-	1502	-	1581	-	1660	-
952	503	-	582	-	661	-	740	-	819	-	898	-	1503	-	1582	-	1661	-
1052	504	-	583	-	662	-	741	-	820	-	899	-	1504	-	1583	-	1662	-
1152	505	-	584	-	663	-	742	-	821	-	900	-	1505	-	1584	-	1663	-
1252	506	-	585	-	664	-	743	-	822	-	901	-	1506	-	1585	-	1664	-
1352	507	-	586	-	665	-	744	-	823	-	902	-	1507	-	1586	-	1665	-
1452	508	-	587	-	666	-	745	-	824	-	903	-	1508	-	1587	-	1666	-
1552	509	-	588	-	667	-	746	-	825	-	904	-	1509	-	1588	-	1667	-
1652	510	-	589	-	668	-	747	-	826	-	905	-	1510	-	1589	-	1668	-
1688	511	-	590	-	669	-	748	-	827	-	906	-	1511	-	1590	-	1669	-
1788	512	-	591	-	670	-	749	-	828	-	907	-	1512	-	1591	-	1670	-
1888	513	-	592	-	671	-	750	-	829	-	908	-	1513	-	1592	-	1671	-
1988	514	-	593	-	672	-	751	-	830	-	909	-	1514	-	1593	-	1672	-
2088	515	-	594	-	673	-	752	-	831	-	910	-	1515	-	1594	-	1673	-
2188	516	-	595	-	674	-	753	-	832	-	911	-	1516	-	1595	-	1674	-
2288	517	-	596	-	675	-	754	-	833	-	912	-	1517	-	1596	-	1675	-
2388	518	-	597	-	676	-	755	-	834	-	913	-	1518	-	1597	-	1676	-
2488	519	-	598	-	677	-	756	-	835	-	914	-	1519	-	1598	-	1677	-
2588	520	-	599	-	678	-	757	-	836	-	915	-	1520	-	1599	-	1678	-
2688	521	-	600	-	679	-	758	-	837	-	916	-	1521	-	1600	-	1679	-
2788	522	-	601	-	680	-	759	-	838	-	917	-	1522	-	1601	-	1680	-
2888	523	-	602	-	681	-	760	-	839	-	918	-	1523	-	1602	-	1681	-
2988	524	-	603	-	682	-	761	-	840	-	919	-	1524	-	1603	-	1682	-
3088	525	-	604	-	683	-	762	-	841	-	920	-	1525	-	1604	-	1683	-
3188	526	-	605	-	684	-	763	-	842	-	921	-	1526	-	1605	-	1684	-
3288	527	-	606	-	685	-	764	-	843	-	922	-	1527	-	1606	-	1685	-
3324	528	-	607	-	686	-	765	-	844	-	923	-	1528	-	1607	-	1686	

Linear shelving 400 mm

3 LEVELS		4 LEVELS		5 LEVELS	
SET Nº	SHELVING ITEMS BREAKDOWN	SET Nº	SHELVING ITEMS BREAKDOWN	SET Nº	SHELVING ITEMS BREAKDOWN
10	2 AF17-43 + 3 SA-46	89	2 AF17-44 + 4 SA-46	168	2 AF17-45 + 5 SA-46
11	2 AF17-43 + 3 SA-47	90	2 AF17-44 + 4 SA-47	169	2 AF17-45 + 5 SA-47
12	2 AF17-43 + 3 SA-48	91	2 AF17-44 + 4 SA-48	170	2 AF17-45 + 5 SA-48
13	2 AF17-43 + 3 SA-49	92	2 AF17-44 + 4 SA-49	171	2 AF17-45 + 5 SA-49
14	2 AF17-43 + 3 SA-410	93	2 AF17-44 + 4 SA-410	172	2 AF17-45 + 5 SA-410
15	2 AF17-43 + 3 SA-411	94	2 AF17-44 + 4 SA-411	173	2 AF17-45 + 5 SA-411
16	2 AF17-43 + 3 SA-412	95	2 AF17-44 + 4 SA-412	174	2 AF17-45 + 5 SA-412
17	2 AF17-43 + 3 SA-413	96	2 AF17-44 + 4 SA-413	175	2 AF17-45 + 5 SA-413
18	2 AF17-43 + 3 SA-414	97	2 AF17-44 + 4 SA-414	176	2 AF17-45 + 5 SA-414
19	2 AF17-43 + 3 SA-415	98	2 AF17-44 + 4 SA-415	177	2 AF17-45 + 5 SA-415
20	2 AF17-43 + 3 SA-416	99	2 AF17-44 + 4 SA-416	178	2 AF17-45 + 5 SA-416
21	3 AF17-43 + 6 SA-48	100	3 AF17-44 + 8 SA-48	179	3 AF17-45 + 10 SA-48
22	3 AF17-43 + 3 SA-49 + 3 SA-48	101	3 AF17-44 + 4 SA-49 + 4 SA-48	180	3 AF17-45 + 5 SA-49 + 5 SA-48
23	3 AF17-43 + 6 SA-49	102	3 AF17-44 + 8 SA-49	181	3 AF17-45 + 10 SA-49
24	3 AF17-43 + 3 SA-49 + 3 SA-410	103	3 AF17-44 + 4 SA-49 + 4 SA-410	182	3 AF17-45 + 5 SA-49 + 5 SA-410
25	3 AF17-43 + 6 SA-410	104	3 AF17-44 + 8 SA-410	183	3 AF17-45 + 10 SA-410
26	3 AF17-43 + 3 SA-410 + 3 SA-411	105	3 AF17-44 + 4 SA-410 + 4 SA-411	184	3 AF17-45 + 5 SA-410 + 5 SA-411
27	3 AF17-43 + 6 SA-411	106	3 AF17-44 + 8 SA-411	185	3 AF17-45 + 10 SA-411
28	3 AF17-43 + 3 SA-411 + 3 SA-412	107	3 AF17-44 + 4 SA-411 + 4 SA-412	186	3 AF17-45 + 5 SA-411 + 5 SA-412
29	3 AF17-43 + 6 SA-412	108	3 AF17-44 + 8 SA-412	187	3 AF17-45 + 10 SA-412
30	3 AF17-43 + 3 SA-412 + 3 SA-413	109	3 AF17-44 + 4 SA-412 + 4 SA-413	188	3 AF17-45 + 5 SA-412 + 5 SA-413
31	3 AF17-43 + 6 SA-413	110	3 AF17-44 + 8 SA-413	189	3 AF17-45 + 10 SA-413
32	3 AF17-43 + 3 SA-413 + 3 SA-414	111	3 AF17-44 + 4 SA-413 + 4 SA-414	190	3 AF17-45 + 5 SA-413 + 5 SA-414
33	3 AF17-43 + 6 SA-414	112	3 AF17-44 + 8 SA-414	191	3 AF17-45 + 10 SA-414
34	3 AF17-43 + 3 SA-414 + 3 SA-415	113	3 AF17-44 + 4 SA-414 + 4 SA-415	192	3 AF17-45 + 5 SA-414 + 5 SA-415
35	3 AF17-43 + 6 SA-415	114	3 AF17-44 + 8 SA-415	193	3 AF17-45 + 10 SA-415
36	3 AF17-43 + 3 SA-415 + 3 SA-416	115	3 AF17-44 + 4 SA-415 + 4 SA-416	194	3 AF17-45 + 5 SA-415 + 5 SA-416
37	3 AF17-43 + 6 SA-416	116	3 AF17-44 + 8 SA-416	195	3 AF17-45 + 10 SA-416
38	4 AF17-43 + 3 SA-410 + 6 SA-411	117	4 AF17-44 + 4 SA-410 + 8 SA-411	196	4 AF17-45 + 5 SA-410 + 10 SA-411
39	4 AF17-43 + 9 SA-411	118	4 AF17-44 + 12 SA-411	197	4 AF17-45 + 15 SA-411
40	4 AF17-43 + 6 SA-411 + 3 SA-412	119	4 AF17-44 + 8 SA-411 + 4 SA-412	198	4 AF17-45 + 10 SA-411 + 5 SA-412
41	4 AF17-43 + 3 SA-411 + 6 SA-412	120	4 AF17-44 + 4 SA-411 + 8 SA-412	199	4 AF17-45 + 5 SA-411 + 10 SA-412
42	4 AF17-43 + 9 SA-412	121	4 AF17-44 + 12 SA-412	200	4 AF17-45 + 15 SA-412
43	4 AF17-43 + 6 SA-412 + 3 SA-413	122	4 AF17-44 + 8 SA-412 + 4 SA-413	201	4 AF17-45 + 10 SA-412 + 5 SA-413
44	4 AF17-43 + 3 SA-412 + 6 SA-413	123	4 AF17-44 + 4 SA-412 + 8 SA-413	202	4 AF17-45 + 5 SA-412 + 10 SA-413
45	4 AF17-43 + 9 SA-413	124	4 AF17-44 + 12 SA-413	203	4 AF17-45 + 15 SA-413
46	4 AF17-43 + 6 SA-413 + 3 SA-414	125	4 AF17-44 + 8 SA-413 + 4 SA-414	204	4 AF17-45 + 10 SA-413 + 5 SA-414
47	4 AF17-43 + 3 SA-413 + 6 SA-414	126	4 AF17-44 + 4 SA-413 + 8 SA-414	205	4 AF17-45 + 5 SA-413 + 10 SA-414
48	4 AF17-43 + 9 SA-414	127	4 AF17-44 + 12 SA-414	206	4 AF17-45 + 15 SA-414
49	4 AF17-43 + 6 SA-414 + 3 SA-415	128	4 AF17-44 + 8 SA-414 + 4 SA-415	207	4 AF17-45 + 10 SA-414 + 5 SA-415
50	4 AF17-43 + 3 SA-414 + 6 SA-415	129	4 AF17-44 + 4 SA-414 + 8 SA-415	208	4 AF17-45 + 5 SA-414 + 10 SA-415
51	4 AF17-43 + 9 SA-415	130	4 AF17-44 + 12 SA-415	209	4 AF17-45 + 15 SA-415
52	4 AF17-43 + 6 SA-415 + 3 SA-416	131	4 AF17-44 + 8 SA-415 + 4 SA-416	210	4 AF17-45 + 10 SA-415 + 5 SA-416
53	4 AF17-43 + 3 SA-415 + 6 SA-416	132	4 AF17-44 + 4 SA-415 + 8 SA-416	211	4 AF17-45 + 5 SA-415 + 10 SA-416
54	4 AF17-43 + 9 SA-416	133	4 AF17-44 + 12 SA-416	212	4 AF17-45 + 15 SA-416
55	5 AF17-43 + 12 SA-412	134	5 AF17-44 + 16 SA-412	213	5 AF17-45 + 20 SA-412
56	5 AF17-43 + 9 SA-412 + 3 SA-413	135	5 AF17-44 + 12 SA-412 + 4 SA-413	214	5 AF17-45 + 15 SA-412 + 5 SA-413
57	5 AF17-43 + 6 SA-412 + 6 SA-413	136	5 AF17-44 + 8 SA-412 + 8 SA-413	215	5 AF17-45 + 10 SA-412 + 10 SA-413
58	5 AF17-43 + 3 SA-412 + 9 SA-413	137	5 AF17-44 + 4 SA-412 + 12 SA-413	216	5 AF17-45 + 5 SA-412 + 15 SA-413
59	5 AF17-43 + 12 SA-413	138	5 AF17-44 + 16 SA-413	217	5 AF17-45 + 20 SA-413
60	5 AF17-43 + 9 SA-413 + 3 SA-414	139	5 AF17-44 + 12 SA-413 + 4 SA-414	218	5 AF17-45 + 15 SA-413 + 5 SA-414
61	5 AF17-43 + 6 SA-413 + 6 SA-414	140	5 AF17-44 + 8 SA-413 + 8 SA-414	219	5 AF17-45 + 10 SA-413 + 10 SA-414
62	5 AF17-43 + 3 SA-413 + 9 SA-414	141	5 AF17-44 + 4 SA-413 + 12 SA-414	220	5 AF17-45 + 5 SA-413 + 15 SA-414
63	5 AF17-43 + 12 SA-414	142	5 AF17-44 + 16 SA-414	221	5 AF17-45 + 20 SA-414

Linear shelving 500 mm

3 LEVELS		4 LEVELS		5 LEVELS	
SET Nº	SHELVING ITEMS BREAKDOWN	SET Nº	SHELVING ITEMS BREAKDOWN	SET Nº	SHELVING ITEMS BREAKDOWN
247	2 AF17-53 + 3 SA-56	326	2 AF17-54 + 4 SA-56	405	2 AF17-55 + 5 SA-56
248	2 AF17-53 + 3 SA-57	327	2 AF17-54 + 4 SA-57	406	2 AF17-55 + 5 SA-57
249	2 AF17-53 + 3 SA-58	328	2 AF17-54 + 4 SA-58	407	2 AF17-55 + 5 SA-58
250	2 AF17-53 + 3 SA-59	329	2 AF17-54 + 4 SA-59	408	2 AF17-55 + 5 SA-59
251	2 AF17-53 + 3 SA-510	330	2 AF17-54 + 4 SA-510	409	2 AF17-55 + 5 SA-510
252	2 AF17-53 + 3 SA-511	331	2 AF17-54 + 4 SA-511	410	2 AF17-55 + 5 SA-511
253	2 AF17-53 + 3 SA-512	332	2 AF17-54 + 4 SA-512	411	2 AF17-55 + 5 SA-512
254	2 AF17-53 + 3 SA-513	333	2 AF17-54 + 4 SA-513	412	2 AF17-55 + 5 SA-513
255	2 AF17-53 + 3 SA-514	334	2 AF17-54 + 4 SA-514	413	2 AF17-55 + 5 SA-514
256	2 AF17-53 + 3 SA-515	335	2 AF17-54 + 4 SA-515	414	2 AF17-55 + 5 SA-515
257	2 AF17-53 + 3 SA-516	336	2 AF17-54 + 4 SA-516	415	2 AF17-55 + 5 SA-516
258	3 AF17-53 + 6 SA-58	337	3 AF17-54 + 8 SA-58	416	3 AF17-55 + 10 SA-58
259	3 AF17-53 + 3 SA-59 + 3 SA-58	338	3 AF17-54 + 4 SA-59 + 4 SA-58	417	3 AF17-55 + 5 SA-59 + 5 SA-58
260	3 AF17-53 + 6 SA-59	339	3 AF17-54 + 8 SA-59	418	3 AF17-55 + 10 SA-59
261	3 AF17-53 + 3 SA-59 + 3 SA-510	340	3 AF17-54 + 4 SA-59 + 4 SA-510	419	3 AF17-55 + 5 SA-59 + 5 SA-510
262	3 AF17-53 + 6 SA-510	341	3 AF17-54 + 8 SA-510	420	3 AF17-55 + 10 SA-510
263	3 AF17-53 + 3 SA-510 + 3 SA-511	342	3 AF17-54 + 4 SA-510 + 4 SA-511	421	3 AF17-55 + 5 SA-510 + 5 SA-511
264	3 AF17-53 + 6 SA-511	343	3 AF17-54 + 8 SA-511	422	3 AF17-55 + 10 SA-511
265	3 AF17-53 + 3 SA-511 + 3 SA-512	344	3 AF17-54 + 4 SA-511 + 4 SA-512	423	3 AF17-55 + 5 SA-511 + 5 SA-512
266	3 AF17-53 + 6 SA-512	345	3 AF17-54 + 8 SA-512	424	3 AF17-55 + 10 SA-512
267	3 AF17-53 + 3 SA-512 + 3 SA-513	346	3 AF17-54 + 4 SA-512 + 4 SA-513	425	3 AF17-55 + 5 SA-512 + 5 SA-513
268	3 AF17-53 + 6 SA-513	347	3 AF17-54 + 8 SA-513	426	3 AF17-55 + 10 SA-513
269	3 AF17-53 + 3 SA-513 + 3 SA-514	348	3 AF17-54 + 4 SA-513 + 4 SA-514	427	3 AF17-55 + 5 SA-513 + 5 SA-514
270	3 AF17-53 + 6 SA-514	349	3 AF17-54 + 8 SA-514	428	3 AF17-55 + 10 SA-514
271	3 AF17-53 + 3 SA-514 + 3 SA-515	350	3 AF17-54 + 4 SA-514 + 4 SA-515	429	3 AF17-55 + 5 SA-514 + 5 SA-515
272	3 AF17-53 + 6 SA-515	351	3 AF17-54 + 8 SA-515	430	3 AF17-55 + 10 SA-515
273	3 AF17-53 + 3 SA-515 + 3 SA-516	352	3 AF17-54 + 4 SA-515 + 4 SA-516	431	3 AF17-55 + 5 SA-515 + 5 SA-516
274	3 AF17-53 + 6 SA-516	353	3 AF17-54 + 8 SA-516	432	3 AF17-55 + 10 SA-516
275	4 AF17-53 + 3 SA-510 + 6 SA-511	354	4 AF17-54 + 4 SA-510 + 8 SA-511	433	4 AF17-55 + 5 SA-510 + 10 SA-511
276	4 AF17-53 + 9 SA-511	355	4 AF17-54 + 12 SA-511	434	4 AF17-55 + 15 SA-511
277	4 AF17-53 + 6 SA-511 + 3 SA-512	356	4 AF17-54 + 8 SA-511 + 4 SA-512	435	4 AF17-55 + 10 SA-511 + 5 SA-512
278	4 AF17-53 + 3 SA-511 + 6 SA-512	357	4 AF17-54 + 4 SA-511 + 8 SA-512	436	4 AF17-55 + 5 SA-511 + 10 SA-512
279	4 AF17-53 + 9 SA-512	358	4 AF17-54 + 12 SA-512	437	4 AF17-55 + 15 SA-512
280	4 AF17-53 + 6 SA-512 + 3 SA-513	359	4 AF17-54 + 8 SA-512 + 4 SA-513	438	4 AF17-55 + 10 SA-512 + 5 SA-513
281	4 AF17-53 + 3 SA-512 + 6 SA-513	360	4 AF17-54 + 4 SA-512 + 8 SA-513	439	4 AF17-55 + 5 SA-512 + 10 SA-513
282	4 AF17-53 + 9 SA-513	361	4 AF17-54 + 12 SA-513	440	4 AF17-55 + 15 SA-513
283	4 AF17-53 + 6 SA-513 + 3 SA-514	362	4 AF17-54 + 8 SA-513 + 4 SA-514	441	4 AF17-55 + 10 SA-513 + 5 SA-514
284	4 AF17-53 + 3 SA-513 + 6 SA-514	363	4 AF17-54 + 4 SA-513 + 8 SA-514	442	4 AF17-55 + 5 SA-513 + 10 SA-514
285	4 AF17-53 + 9 SA-514	364	4 AF17-54 + 12 SA-514	443	4 AF17-55 + 15 SA-514
286	4 AF17-53 + 6 SA-514 + 3 SA-515	365	4 AF17-54 + 8 SA-514 + 4 SA-515	444	4 AF17-55 + 10 SA-514 + 5 SA-515
287	4 AF17-53 + 3 SA-514 + 6 SA-515	366	4 AF17-54 + 4 SA-514 + 8 SA-515	445	4 AF17-55 + 5 SA-514 + 10 SA-515
288	4 AF17-53 + 9 SA-515	367	4 AF17-54 + 12 SA-515	446	4 AF17-55 + 15 SA-515
289	4 AF17-53 + 6 SA-515 + 3 SA-516	368	4 AF17-54 + 8 SA-515 + 4 SA-516	447	4 AF17-55 + 10 SA-515 + 5 SA-516
290	4 AF17-53 + 3 SA-515 + 6 SA-516	369	4 AF17-54 + 4 SA-515 + 8 SA-516	448	4 AF17-55 + 5 SA-515 + 10 SA-516
291	4 AF17-53 + 9 SA-516	370	4 AF17-54 + 12 SA-516	449	4 AF17-55 + 15 SA-516
292	5 AF17-53 + 12 SA-512	371	5 AF17-54 + 16 SA-512	450	5 AF17-55 + 20 SA-512
293	5 AF17-53 + 9 SA-512 + 3 SA-513	372	5 AF17-54 + 12 SA-512 + 4 SA-513	451	5 AF17-55 + 15 SA-512 + 5 SA-513
294	5 AF17-53 + 6 SA-512 + 6 SA-513	373	5 AF17-54 + 8 SA-512 + 8 SA-513	452	5 AF17-55 + 10 SA-512 + 10 SA-513
295	5 AF17-53 + 3 SA-512 + 9 SA-513	374	5 AF17-54 + 4 SA-512 + 12 SA-513	453	5 AF17-55 + 5 SA-512 + 15 SA-513
296	5 AF17-53 + 12 SA-513	375	5 AF17-54 + 16 SA-513	454	5 AF17-55 + 20 SA-513
297	5 AF17-53 + 9 SA-513 + 3 SA-514	376	5 AF17-54 + 12 SA-513 + 4 SA-514	455	5 AF17-55 + 15 SA-513 + 5 SA-514
298	5 AF17-53 + 6 SA-513 + 6 SA-514	377	5 AF17-54 + 8 SA-513 + 8 SA-514	456	5 AF17-55 + 10 SA-513 + 10 SA-514
299	5 AF17-53 + 3 SA-513 + 9 SA-514	378	5 AF17-54 + 4 SA-513 + 12 SA-514	457	5 AF17-55 + 5 SA-513 + 15 SA-514
300	5 AF17-53 + 12 SA-514	379	5 AF17-54 + 16 SA-514	458	5 AF17-55 + 20 SA-514



## Linear shelving 600 mm

3 LEVELS		4 LEVELS		5 LEVELS	
SET Nº	SHELVING ITEMS BREAKDOWN	SET Nº	SHELVING ITEMS BREAKDOWN	SET Nº	SHELVING ITEMS BREAKDOWN
1000	2 AF17-63 + 3 SA-66	1089	2 AF17-64 + 4 SA-66	1168	2 AF17-65 + 5 SA-66
1011	2 AF17-63 + 3 SA-67	1090	2 AF17-64 + 4 SA-67	1169	2 AF17-65 + 5 SA-67
1012	2 AF17-63 + 3 SA-68	1091	2 AF17-64 + 4 SA-68	1170	2 AF17-65 + 5 SA-68
1013	2 AF17-63 + 3 SA-69	1092	2 AF17-64 + 4 SA-69	1171	2 AF17-65 + 5 SA-69
1014	2 AF17-63 + 3 SA-610	1093	2 AF17-64 + 4 SA-610	1172	2 AF17-65 + 5 SA-610
1015	2 AF17-63 + 3 SA-611	1094	2 AF17-64 + 4 SA-611	1173	2 AF17-65 + 5 SA-611
1016	2 AF17-63 + 3 SA-612	1095	2 AF17-64 + 4 SA-612	1174	2 AF17-65 + 5 SA-612
1017	2 AF17-63 + 3 SA-613	1096	2 AF17-64 + 4 SA-613	1175	2 AF17-65 + 5 SA-613
1018	2 AF17-63 + 3 SA-614	1097	2 AF17-64 + 4 SA-614	1176	2 AF17-65 + 5 SA-614
1019	2 AF17-63 + 3 SA-615	1098	2 AF17-64 + 4 SA-615	1177	2 AF17-65 + 5 SA-615
1020	2 AF17-63 + 3 SA-616	1099	2 AF17-64 + 4 SA-616	1178	2 AF17-65 + 5 SA-616
1021	3 AF17-63 + 6 SA-68	700	3 AF17-64 + 8 SA-68	1179	3 AF17-65 + 10 SA-68
1022	3 AF17-63 + 3 SA-69 + 3 SA-68	1101	3 AF17-64 + 4 SA-69 + 4 SA-68	1180	3 AF17-65 + 5 SA-69 + 5 SA-68
1023	3 AF17-63 + 6 SA-69	1102	3 AF17-64 + 8 SA-69	1181	3 AF17-65 + 10 SA-69
1024	3 AF17-63 + 3 SA-69 + 3 SA-610	1103	3 AF17-64 + 4 SA-69 + 4 SA-610	1182	3 AF17-65 + 5 SA-69 + 5 SA-610
1025	3 AF17-63 + 6 SA-610	1104	3 AF17-64 + 8 SA-610	1183	3 AF17-65 + 10 SA-610
1026	3 AF17-63 + 3 SA-610 + 3 SA-611	1105	3 AF17-64 + 4 SA-610 + 4 SA-611	1184	3 AF17-65 + 5 SA-610 + 5 SA-611
1027	3 AF17-63 + 6 SA-611	1106	3 AF17-64 + 8 SA-611	1185	3 AF17-65 + 10 SA-611
1028	3 AF17-63 + 3 SA-611 + 3 SA-612	1107	3 AF17-64 + 4 SA-611 + 4 SA-612	1186	3 AF17-65 + 5 SA-611 + 5 SA-612
1029	3 AF17-63 + 6 SA-612	1108	3 AF17-64 + 8 SA-612	1187	3 AF17-65 + 10 SA-612
1030	3 AF17-63 + 3 SA-612 + 3 SA-613	1109	3 AF17-64 + 4 SA-612 + 4 SA-613	1188	3 AF17-65 + 5 SA-612 + 5 SA-613
1031	3 AF17-63 + 6 SA-613	1110	3 AF17-64 + 8 SA-613	1189	3 AF17-65 + 10 SA-613
1032	3 AF17-63 + 3 SA-613 + 3 SA-614	1111	3 AF17-64 + 4 SA-613 + 4 SA-614	1190	3 AF17-65 + 5 SA-613 + 5 SA-614
1033	3 AF17-63 + 6 SA-614	1112	3 AF17-64 + 8 SA-614	1191	3 AF17-65 + 10 SA-614
1034	3 AF17-63 + 3 SA-614 + 3 SA-615	1113	3 AF17-64 + 4 SA-614 + 4 SA-615	1192	3 AF17-65 + 5 SA-614 + 5 SA-615
1035	3 AF17-63 + 6 SA-615	1114	3 AF17-64 + 8 SA-615	1193	3 AF17-65 + 10 SA-615
1036	3 AF17-63 + 3 SA-615 + 3 SA-616	1115	3 AF17-64 + 4 SA-615 + 4 SA-616	1194	3 AF17-65 + 5 SA-615 + 5 SA-616
1037	3 AF17-63 + 6 SA-616	1116	3 AF17-64 + 8 SA-616	1195	3 AF17-65 + 10 SA-616
1038	4 AF17-63 + 3 SA-610 + 6 SA-611	1117	4 AF17-64 + 4 SA-610 + 8 SA-611	1196	4 AF17-65 + 5 SA-610 + 10 SA-611
1039	4 AF17-63 + 9 SA-611	1118	4 AF17-64 + 12 SA-611	1197	4 AF17-65 + 15 SA-611
1040	4 AF17-63 + 6 SA-611 + 3 SA-612	1119	4 AF17-64 + 8 SA-611 + 4 SA-612	1198	4 AF17-65 + 10 SA-611 + 5 SA-612
1041	4 AF17-63 + 3 SA-611 + 6 SA-612	1120	4 AF17-64 + 4 SA-611 + 8 SA-612	1199	4 AF17-65 + 5 SA-611 + 10 SA-612
1042	4 AF17-63 + 9 SA-612	1121	4 AF17-64 + 12 SA-612	1200	4 AF17-65 + 15 SA-612
1043	4 AF17-63 + 6 SA-612 + 3 SA-613	1122	4 AF17-64 + 8 SA-612 + 4 SA-613	1201	4 AF17-65 + 10 SA-612 + 5 SA-613
1044	4 AF17-63 + 3 SA-612 + 6 SA-613	1123	4 AF17-64 + 4 SA-612 + 8 SA-613	1202	4 AF17-65 + 5 SA-612 + 10 SA-613
1045	4 AF17-63 + 9 SA-613	1124	4 AF17-64 + 12 SA-613	1203	4 AF17-65 + 15 SA-613
1046	4 AF17-63 + 6 SA-613 + 3 SA-614	1125	4 AF17-64 + 8 SA-613 + 4 SA-614	1204	4 AF17-65 + 10 SA-613 + 5 SA-614
1047	4 AF17-63 + 3 SA-613 + 6 SA-614	1126	4 AF17-64 + 4 SA-613 + 8 SA-614	1205	4 AF17-65 + 5 SA-613 + 10 SA-614
1048	4 AF17-63 + 9 SA-614	1127	4 AF17-64 + 12 SA-614	1206	4 AF17-65 + 15 SA-614
1049	4 AF17-63 + 6 SA-614 + 3 SA-615	1128	4 AF17-64 + 8 SA-614 + 4 SA-615	1207	4 AF17-65 + 10 SA-614 + 5 SA-615
1050	4 AF17-63 + 3 SA-614 + 6 SA-615	1129	4 AF17-64 + 4 SA-614 + 8 SA-615	1208	4 AF17-65 + 5 SA-614 + 10 SA-615
1051	4 AF17-63 + 9 SA-615	1130	4 AF17-64 + 12 SA-615	1209	4 AF17-65 + 15 SA-615
1052	4 AF17-63 + 6 SA-615 + 3 SA-616	1131	4 AF17-64 + 8 SA-615 + 4 SA-616	1210	4 AF17-65 + 10 SA-615 + 5 SA-616
1053	4 AF17-63 + 3 SA-615 + 6 SA-616	1132	4 AF17-64 + 4 SA-615 + 8 SA-616	1211	4 AF17-65 + 5 SA-615 + 10 SA-616
1054	4 AF17-63 + 9 SA-616	1133	4 AF17-64 + 12 SA-616	1212	4 AF17-65 + 15 SA-616
1055	5 AF17-63 + 12 SA-612	1134	5 AF17-64 + 16 SA-612	1213	5 AF17-65 + 20 SA-612
1056	5 AF17-63 + 9 SA-612 + 3 SA-613	1135	5 AF17-64 + 12 SA-612 + 4 SA-613	1214	5 AF17-65 + 15 SA-612 + 5 SA-613
1057	5 AF17-63 + 6 SA-612 + 6 SA-613	1136	5 AF17-64 + 8 SA-612 + 8 SA-613	1215	5 AF17-65 + 10 SA-612 + 10 SA-613
1058	5 AF17-63 + 3 SA-612 + 9 SA-613	1137	5 AF17-64 + 4 SA-612 + 12 SA-613	1216	5 AF17-65 + 5 SA-612 + 15 SA-613
1059	5 AF17-63 + 12 SA-613	1138	5 AF17-64 + 16 SA-613	1217	5 AF17-65 + 20 SA-613
1060	5 AF17-63 + 9 SA-613 + 3 SA-614	1139	5 AF17-64 + 12 SA-613 + 4 SA-614	1218	5 AF17-65 + 15 SA-613 + 5 SA-614
1061	5 AF17-63 + 6 SA-613 + 6 SA-614	1140	5 AF17-64 + 8 SA-613 + 8 SA-614	1219	5 AF17-65 + 10 SA-613 + 10 SA-614
1062	5 AF17-63 + 3 SA-613 + 9 SA-614	1141	5 AF17-64 + 4 SA-613 + 12 SA-614	1220	5 AF17-65 + 5 SA-613 + 15 SA-614
1063	5 AF17-63 + 12 SA-614	1142	5 AF17-64 + 16 SA-614	1221	5 AF17-65 + 20 SA-614

## Corner shelving 400 mm

3 LEVELS		4 LEVELS		5 LEVELS	
SET Nº	SHELVING ITEMS BREAKDOWN	SET Nº	SHELVING ITEMS BREAKDOWN	SET Nº	SHELVING ITEMS BREAKDOWN
500	1 AF17-43 + 3 SA-46 + 6 HK	579	1 AF17-44 + 4 SA-46 + 8 HK	658	1 AF17-45 + 5 SA-46 + 10 HK
501	1 AF17-43 + 3 SA-47 + 6 HK	580	1 AF17-44 + 4 SA-47 + 8 HK	659	1 AF17-45 + 5 SA-47 + 10 HK
502	1 AF17-43 + 3 SA-48 + 6 HK	581	1 AF17-44 + 4 SA-48 + 8 HK	660	1 AF17-45 + 5 SA-48 + 10 HK
503	1 AF17-43 + 3 SA-49 + 6 HK	582	1 AF17-44 + 4 SA-49 + 8 HK	661	1 AF17-45 + 5 SA-49 + 10 HK
504	1 AF17-43 + 3 SA-410 + 6 HK	583	1 AF17-44 + 4 SA-410 + 8 HK	662	1 AF17-45 + 5 SA-410 + 10 HK
505	1 AF17-43 + 3 SA-411 + 6 HK	584	1 AF17-44 + 4 SA-411 + 8 HK	663	1 AF17-45 + 5 SA-411 + 10 HK
506	1 AF17-43 + 3 SA-412 + 6 HK	585	1 AF17-44 + 4 SA-412 + 8 HK	664	1 AF17-45 + 5 SA-412 + 10 HK
507	1 AF17-43 + 3 SA-413 + 6 HK	586	1 AF17-44 + 4 SA-413 + 8 HK	665	1 AF17-45 + 5 SA-413 + 10 HK
508	1 AF17-43 + 3 SA-414 + 6 HK	587	1 AF17-44 + 4 SA-414 + 8 HK	666	1 AF17-45 + 5 SA-414 + 10 HK
509	1 AF17-43 + 3 SA-415 + 6 HK	588	1 AF17-44 + 4 SA-415 + 8 HK	667	1 AF17-45 + 5 SA-415 + 10 HK
510	1 AF17-43 + 3 SA-416 + 6 HK	589	1 AF17-44 + 4 SA-416 + 8 HK	668	1 AF17-45 + 5 SA-416 + 10 HK
511	2 AF17-43 + 6 SA-48 + 6 HK	590	2 AF17-44 + 8 SA-48 + 8 HK	669	2 AF17-45 + 10 SA-48 + 10 HK
512	2 AF17-43 + 3 SA-49 + 3 SA-48 + 6 HK	591	2 AF17-44 + 4 SA-49 + 4 SA-48 + 8 HK	670	2 AF17-45 + 5 SA-49 + 5 SA-48 + 10 HK
513	2 AF17-43 + 6 SA-49 + 6 HK	592	2 AF17-44 + 8 SA-49 + 8 HK	671	2 AF17-45 + 10 SA-49 + 10 HK
514	2 AF17-43 + 3 SA-49 + 3 SA-410 + 6 HK	593	2 AF17-44 + 4 SA-49 + 4 SA-410 + 8 HK	672	2 AF17-45 + 5 SA-49 + 5 SA-410 + 10 HK
515	2 AF17-43 + 6 SA-410 + 6 HK	594	2 AF17-44 + 8 SA-410 + 8 HK	673	2 AF17-45 + 10 SA-410 + 10 HK
516	2 AF17-43 + 3 SA-410 + 3 SA-411 + 6 HK	595	2 AF17-44 + 4 SA-410 + 4 SA-411 + 8 HK	674	2 AF17-45 + 5 SA-410 + 5 SA-411 + 10 HK
517	2 AF17-43 + 6 SA-411 + 6 HK	596	2 AF17-44 + 8 SA-411 + 8 HK	675	2 AF17-45 + 10 SA-411 + 10 HK
518	2 AF17-43 + 3 SA-411 + 3 SA-412 + 6 HK	597	2 AF17-44 + 4 SA-411 + 4 SA-412 + 8 HK	676	2 AF17-45 + 5 SA-411 + 5 SA-412 + 10 HK
519	2 AF17-43 + 6 SA-412 + 6 HK	598	2 AF17-44 + 8 SA-412 + 8 HK	677	2 AF17-45 + 10 SA-412 + 10 HK
520	2 AF17-43 + 3 SA-412 + 3 SA-413 + 6 HK	599	2 AF17-44 + 4 SA-412 + 4 SA-413 + 8 HK	678	2 AF17-45 + 5 SA-412 + 5 SA-413 + 10 HK
521	2 AF17-43 + 6 SA-413 + 6 HK	600	2 AF17-44 + 8 SA-413 + 8 HK	679	2 AF17-45 + 10 SA-413 + 10 HK
522	2 AF17-43 + 3 SA-413 + 3 SA-414 + 6 HK	601	2 AF17-44 + 4 SA-413 + 4 SA-414 + 8 HK	680	2 AF17-45 + 5 SA-413 + 5 SA-414 + 10 HK
523	2 AF17-43 + 6 SA-414 + 6 HK	602	2 AF17-44 + 8 SA-414 + 8 HK	681	2 AF17-45 + 10 SA-414 + 10 HK
524	2 AF17-43 + 3 SA-414 + 3 SA-415 + 6 HK	603	2 AF17-44 + 4 SA-414 + 4 SA-415 + 8 HK	682	2 AF17-45 + 5 SA-414 + 5 SA-415 + 10 HK
525	2 AF17-43 + 6 SA-415 + 6 HK	604	2 AF17-44 + 8 SA-415 + 8 HK	683	2 AF17-45 + 10 SA-415 + 10 HK
526	2 AF17-43 + 3 SA-415 + 3 SA-416 + 6 HK	605	2 AF17-44 + 4 SA-415 + 4 SA-416 + 8 HK	684	2 AF17-45 + 5 SA-415 + 5 SA-416 + 10 HK
527	2 AF17-43 + 6 SA-416 + 6 HK	606	2 AF17-44 + 8 SA-416 + 8 HK	685	2 AF17-45 + 10 SA-416 + 10 HK
528	3 AF17-43 + 3 SA-410 + 6 SA-411 + 6 HK	607	3 AF17-44 + 4 SA-410 + 8 SA-411 + 8 HK	686	3 AF17-45 + 5 SA-410 + 10 SA-411 + 10 HK
529	3 AF17-43 + 9 SA-411 + 6 HK	608	3 AF17-44 + 12 SA-411 + 8 HK	687	3 AF17-45 + 15 SA-411 + 10 HK
530	3 AF17-43 + 6 SA-411 + 3 SA-412 + 6 HK	609	3 AF17-44 + 8 SA-411 + 4 SA-412 + 8 HK	688	3 AF17-45 + 10 SA-411 + 5 SA-412 + 10 HK
531	3 AF17-43 + 3 SA-411 + 6 SA-412 + 6 HK	610	3 AF17-44 + 4 SA-411 + 8 SA-412 + 8 HK	689	3 AF17-45 + 5 SA-411 + 10 SA-412 + 10 HK
532	3 AF17-43 + 9 SA-412 + 6 HK	611	3 AF17-44 + 12 SA-412 + 8 HK	690	3 AF17-45 + 15 SA-412 + 10 HK
533	3 AF17-43 + 6 SA-412 + 3 SA-413 + 6 HK	612	3 AF17-44 + 8 SA-412 + 4 SA-413 + 8 HK	691	3 AF17-45 + 10 SA-412 + 5 SA-413 + 10 HK
534	3 AF17-43 + 3 SA-412 + 6 SA-413 + 6 HK	613	3 AF17-44 + 4 SA-412 + 8 SA-413 + 8 HK	692	3 AF17-45 + 5 SA-412 + 10 SA-413 + 10 HK
535	3 AF17-43 + 9 SA-413 + 6 HK	614	3 AF17-44 + 12 SA-413 + 8 HK	693	3 AF17-45 + 15 SA-413 + 10 HK
536	3 AF17-43 + 6 SA-413 + 3 SA-414 + 6 HK	615	3 AF17-44 + 8 SA-413 + 4 SA-414 + 8 HK	694	3 AF17-45 + 10 SA-413 + 5 SA-414 + 10 HK
537	3 AF17-43 + 3 SA-413 + 6 SA-414 + 6 HK	616	3 AF17-44 + 4 SA-413 + 8 SA-414 + 8 HK	695	3 AF17-45 + 5 SA-413 + 10 SA-414 + 10 HK
538	3 AF17-43 + 9 SA-414 + 6 HK	617	3 AF17-44 + 12 SA-414 + 8 HK	696	3 AF17-45 + 15 SA-414 + 10 HK
539	3 AF17-43 + 6 SA-414 + 3 SA-415 + 6 HK	618	3 AF17-44 + 8 SA-414 + 4 SA-415 + 8 HK	697	3 AF17-45 + 10 SA-414 + 5 SA-415 + 10 HK
540	3 AF17-43 + 3 SA-414 + 6 SA-415 + 6 HK	619	3 AF17-44 + 4 SA-414 + 8 SA-415 + 8 HK	698	3 AF17-45 + 5 SA-414 + 10 SA-415 + 10 HK
541	3 AF17-43 + 9 SA-415 + 6 HK	620	3 AF17-44 + 12 SA-415 + 8 HK	699	3 AF17-45 + 15 SA-415 + 10 HK
542	3 AF17-43 + 6 SA-415 + 3 SA-416 + 6 HK	621	3 AF17-44 + 8 SA-415 + 4 SA-416 + 8 HK	700	3 AF17-45 + 10 SA-415 + 5 SA-416 + 10 HK
543	3 AF17-43 + 3 SA-415 + 6 SA-416 + 6 HK	622	3 AF17-44 + 4 SA-415 + 8 SA-416 + 8 HK	701	3 AF17-45 + 5 SA-415 + 10 SA-416 + 10 HK
544	3 AF17-43 + 9 SA-416 + 6 HK	623	3 AF17-44 + 12 SA-416 + 8 HK	702	3 AF17-45 + 15 SA-416 + 10 HK
545	4 AF17-43 + 12 SA-412 + 6 HK	624	4 AF17-44 + 16 SA-412 + 8 HK	703	4 AF17-45 + 20 SA-412 + 10 HK
546	4 AF17-43 + 9 SA-412 + 3 SA-413 + 6 HK	625	4 AF17-44 + 12 SA-412 + 4 SA-413 + 8 HK	704	4 AF17-45 + 15 SA-412 + 5 SA-413 + 10 HK
547	4 AF17-43 + 6 SA-412 + 6 SA-413 + 6 HK	626	4 AF17-44 + 8 SA-412 + 8 SA-413 + 8 HK	705	4 AF17-45 + 10 SA-412 + 10 SA-413 + 10 HK
548	4 AF17-43 + 3 SA-412 + 9 SA-413 + 6 HK	627	4 AF17-44 + 4 SA-412 + 12 SA-413 + 8 HK	706	4 AF17-45 + 5 SA-412 + 15 SA-413 + 10 HK
549	4 AF17-43 + 12 SA-413 + 6 HK	628	4 AF17-44 + 16 SA-413 + 8 HK	707	4 AF17-45 + 20 SA-413 + 10 HK
550	4 AF17-43 + 9 SA-413 + 3 SA-414 + 6 HK	629	4 AF17-44 + 12 SA-413 + 4 SA-414 + 8 HK	708	4 AF17-45 + 15 SA-413 + 5 SA-414 + 10 HK
551	4 AF17-43 + 6 SA-413 + 6 SA-414 + 6 HK	630	4 AF17-44 + 8 SA-413 + 8 SA-414 + 8 HK	709	4 AF17-45 + 10 SA-413 + 10 SA-414 + 10 HK
552	4 AF17-43 + 3 SA-413 + 9 SA-414 + 6 HK	631	4 AF17-44 + 4 SA-413 + 12 SA-414 + 8 HK	710	4 AF17-45 + 5 SA-413 + 15 SA-414 + 10 HK
553	4 AF17-43 + 12 SA-414 + 6 HK	632	4 AF17-44 + 16 SA-414 + 8 HK	711	4 AF17-45 + 20 SA-414 + 10 HK

### Corner shelving 500 mm

3 LEVELS		4 LEVELS		5 LEVELS	
SET Nº	SHELVING ITEMS BREAKDOWN	SET Nº	SHELVING ITEMS BREAKDOWN	SET Nº	SHELVING ITEMS BREAKDOWN
737	1 AF17-53 + 3 SA-56 + 6 HK	816	1 AF17-54 + 4 SA-56 + 8 HK	895	1 AF17-55 + 5 SA-56 + 10 HK
738	1 AF17-53 + 3 SA-57 + 6 HK	817	1 AF17-54 + 4 SA-57 + 8 HK	896	1 AF17-55 + 5 SA-57 + 10 HK
739	1 AF17-53 + 3 SA-58 + 6 HK	818	1 AF17-54 + 4 SA-58 + 8 HK	897	1 AF17-55 + 5 SA-58 + 10 HK
740	1 AF17-53 + 3 SA-59 + 6 HK	819	1 AF17-54 + 4 SA-59 + 8 HK	898	1 AF17-55 + 5 SA-59 + 10 HK
741	1 AF17-53 + 3 SA-510 + 6 HK	820	1 AF17-54 + 4 SA-510 + 8 HK	899	1 AF17-55 + 5 SA-510 + 10 HK
742	1 AF17-53 + 3 SA-511 + 6 HK	821	1 AF17-54 + 4 SA-511 + 8 HK	900	1 AF17-55 + 5 SA-511 + 10 HK
743	1 AF17-53 + 3 SA-512 + 6 HK	822	1 AF17-54 + 4 SA-512 + 8 HK	901	1 AF17-55 + 5 SA-512 + 10 HK
744	1 AF17-53 + 3 SA-513 + 6 HK	823	1 AF17-54 + 4 SA-513 + 8 HK	902	1 AF17-55 + 5 SA-513 + 10 HK
745	1 AF17-53 + 3 SA-514 + 6 HK	824	1 AF17-54 + 4 SA-514 + 8 HK	903	1 AF17-55 + 5 SA-514 + 10 HK
746	1 AF17-53 + 3 SA-515 + 6 HK	825	1 AF17-54 + 4 SA-515 + 8 HK	904	1 AF17-55 + 5 SA-515 + 10 HK
747	1 AF17-53 + 3 SA-516 + 6 HK	826	1 AF17-54 + 4 SA-516 + 8 HK	905	1 AF17-55 + 5 SA-516 + 10 HK
748	2 AF17-53 + 6 SA-58 + 6 HK	827	2 AF17-54 + 8 SA-58 + 8 HK	906	2 AF17-55 + 10 SA-58 + 10 HK
749	2 AF17-53 + 3 SA-59 + 3 SA-58 + 6 HK	828	2 AF17-54 + 4 SA-59 + 4 SA-58 + 8 HK	907	2 AF17-55 + 5 SA-59 + 5 SA-58 + 10 HK
750	2 AF17-53 + 6 SA-59 + 6 HK	829	2 AF17-54 + 8 SA-59 + 8 HK	908	2 AF17-55 + 10 SA-59 + 10 HK
751	2 AF17-53 + 3 SA-59 + 3 SA-510 + 6 HK	830	2 AF17-54 + 4 SA-59 + 4 SA-510 + 8 HK	909	2 AF17-55 + 5 SA-59 + 5 SA-510 + 10 HK
752	2 AF17-53 + 6 SA-510 + 6 HK	831	2 AF17-54 + 8 SA-510 + 8 HK	910	2 AF17-55 + 10 SA-510 + 10 HK
753	2 AF17-53 + 3 SA-510 + 3 SA-511 + 6 HK	832	2 AF17-54 + 4 SA-510 + 4 SA-511 + 8 HK	911	2 AF17-55 + 5 SA-510 + 5 SA-511 + 10 HK
754	2 AF17-53 + 6 SA-511 + 6 HK	833	2 AF17-54 + 8 SA-511 + 8 HK	912	2 AF17-55 + 10 SA-511 + 10 HK
755	2 AF17-53 + 3 SA-511 + 3 SA-512 + 6 HK	834	2 AF17-54 + 4 SA-511 + 4 SA-512 + 8 HK	913	2 AF17-55 + 5 SA-511 + 5 SA-512 + 10 HK
756	2 AF17-53 + 6 SA-512 + 6 HK	835	2 AF17-54 + 8 SA-512 + 8 HK	914	2 AF17-55 + 10 SA-512 + 10 HK
757	2 AF17-53 + 3 SA-512 + 3 SA-513 + 6 HK	836	2 AF17-54 + 4 SA-512 + 4 SA-513 + 8 HK	915	2 AF17-55 + 5 SA-512 + 5 SA-513 + 10 HK
758	2 AF17-53 + 6 SA-513 + 6 HK	837	2 AF17-54 + 8 SA-513 + 8 HK	916	2 AF17-55 + 10 SA-513 + 10 HK
759	2 AF17-53 + 3 SA-513 + 3 SA-514 + 6 HK	838	2 AF17-54 + 4 SA-513 + 4 SA-514 + 8 HK	917	2 AF17-55 + 5 SA-513 + 5 SA-514 + 10 HK
760	2 AF17-53 + 6 SA-514 + 6 HK	839	2 AF17-54 + 8 SA-514 + 8 HK	918	2 AF17-55 + 10 SA-514 + 10 HK
761	2 AF17-53 + 3 SA-514 + 3 SA-515 + 6 HK	840	2 AF17-54 + 4 SA-514 + 4 SA-515 + 8 HK	919	2 AF17-55 + 5 SA-514 + 5 SA-515 + 10 HK
762	2 AF17-53 + 6 SA-515 + 6 HK	841	2 AF17-54 + 8 SA-515 + 8 HK	920	2 AF17-55 + 10 SA-515 + 10 HK
763	2 AF17-53 + 3 SA-515 + 3 SA-516 + 6 HK	842	2 AF17-54 + 4 SA-515 + 4 SA-516 + 8 HK	921	2 AF17-55 + 5 SA-515 + 5 SA-516 + 10 HK
764	2 AF17-53 + 6 SA-516 + 6 HK	843	2 AF17-54 + 8 SA-516 + 8 HK	922	2 AF17-55 + 10 SA-516 + 10 HK
765	3 AF17-53 + 3 SA-510 + 6 SA-511 + 6 HK	844	3 AF17-54 + 4 SA-510 + 8 SA-511 + 8 HK	923	3 AF17-55 + 5 SA-510 + 10 SA-511 + 10 HK
766	3 AF17-53 + 9 SA-511 + 6 HK	845	3 AF17-54 + 12 SA-511 + 8 HK	924	3 AF17-55 + 15 SA-511 + 10 HK
767	3 AF17-53 + 6 SA-511 + 3 SA-512 + 6 HK	846	3 AF17-54 + 8 SA-511 + 4 SA-512 + 8 HK	925	3 AF17-55 + 10 SA-511 + 5 SA-512 + 10 HK
768	3 AF17-53 + 3 SA-511 + 6 SA-512 + 6 HK	847	3 AF17-54 + 4 SA-511 + 8 SA-512 + 8 HK	926	3 AF17-55 + 5 SA-511 + 6 SA-512 + 10 HK
769	3 AF17-53 + 9 SA-512 + 6 HK	848	3 AF17-54 + 12 SA-512 + 8 HK	927	3 AF17-55 + 15 SA-512 + 10 HK
770	3 AF17-53 + 6 SA-512 + 3 SA-513 + 6 HK	849	3 AF17-54 + 8 SA-512 + 4 SA-513 + 8 HK	928	3 AF17-55 + 10 SA-512 + 5 SA-513 + 10 HK
771	3 AF17-53 + 3 SA-512 + 6 SA-513 + 6 HK	850	3 AF17-54 + 4 SA-512 + 8 SA-513 + 8 HK	929	3 AF17-55 + 5 SA-512 + 10 SA-513 + 10 HK
772	3 AF17-53 + 9 SA-513 + 6 HK	851	3 AF17-54 + 12 SA-513 + 8 HK	930	3 AF17-55 + 15 SA-513 + 10 HK
773	3 AF17-53 + 6 SA-513 + 3 SA-514 + 6 HK	852	3 AF17-54 + 8 SA-513 + 4 SA-514 + 8 HK	931	3 AF17-55 + 10 SA-513 + 5 SA-514 + 10 HK
774	3 AF17-53 + 3 SA-513 + 6 SA-514 + 6 HK	853	3 AF17-54 + 4 SA-513 + 8 SA-514 + 8 HK	932	3 AF17-55 + 5 SA-513 + 10 SA-514 + 10 HK
775	3 AF17-53 + 9 SA-514 + 6 HK	854	3 AF17-54 + 12 SA-514 + 8 HK	933	3 AF17-55 + 15 SA-514 + 10 HK
776	3 AF17-53 + 6 SA-514 + 3 SA-515 + 6 HK	855	3 AF17-54 + 8 SA-514 + 4 SA-515 + 8 HK	934	3 AF17-55 + 10 SA-514 + 5 SA-515 + 10 HK
777	3 AF17-53 + 3 SA-514 + 6 SA-515 + 6 HK	856	3 AF17-54 + 4 SA-514 + 8 SA-515 + 8 HK	935	3 AF17-55 + 5 SA-514 + 10 SA-515 + 10 HK
778	3 AF17-53 + 9 SA-515 + 6 HK	857	3 AF17-54 + 12 SA-515 + 8 HK	936	3 AF17-55 + 15 SA-515 + 10 HK
779	3 AF17-53 + 6 SA-515 + 3 SA-516 + 6 HK	858	3 AF17-54 + 8 SA-515 + 4 SA-516 + 8 HK	937	3 AF17-55 + 10 SA-515 + 5 SA-516 + 10 HK
780	3 AF17-53 + 3 SA-515 + 6 SA-516 + 6 HK	859	3 AF17-54 + 4 SA-515 + 8 SA-516 + 8 HK	938	3 AF17-55 + 5 SA-515 + 10 SA-516 + 10 HK
781	3 AF17-53 + 9 SA-516 + 6 HK	860	3 AF17-54 + 12 SA-516 + 8 HK	939	3 AF17-55 + 15 SA-516 + 10 HK
782	4 AF17-53 + 12 SA-512 + 6 HK	861	4 AF17-54 + 16 SA-512 + 8 HK	940	4 AF17-55 + 20 SA-512 + 10 HK
783	4 AF17-53 + 9 SA-512 + 3 SA-513 + 6 HK	862	4 AF17-54 + 12 SA-512 + 4 SA-513 + 8 HK	941	4 AF17-55 + 15 SA-512 + 5 SA-513 + 10 HK
784	4 AF17-53 + 6 SA-512 + 6 SA-513 + 6 HK	863	4 AF17-54 + 8 SA-512 + 8 SA-513 + 8 HK	942	4 AF17-55 + 10 SA-512 + 10 SA-513 + 10 HK
785	4 AF17-53 + 3 SA-512 + 9 SA-513 + 6 HK	864	4 AF17-54 + 4 SA-512 + 12 SA-513 + 8 HK	943	4 AF17-55 + 5 SA-512 + 15 SA-513 + 10 HK
786	4 AF17-53 + 12 SA-513 + 6 HK	865	4 AF17-54 + 16 SA-513 + 8 HK	944	4 AF17-55 + 20 SA-513 + 10 HK
787	4 AF17-53 + 9 SA-513 + 3 SA-514 + 6 HK	866	4 AF17-54 + 12 SA-513 + 4 SA-514 + 8 HK	945	4 AF17-55 + 15 SA-513 + 5 SA-514 + 10 HK
788	4 AF17-53 + 6 SA-513 + 6 SA-514 + 6 HK	867	4 AF17-54 + 8 SA-513 + 8 SA-514 + 8 HK	946	4 AF17-55 + 10 SA-513 + 10 SA-514 + 10 HK
789	4 AF17-53 + 3 SA-513 + 9 SA-514 + 6 HK	868	4 AF17-54 + 4 SA-513 + 12 SA-514 + 8 HK	947	4 AF17-55 + 5 SA-513 + 15 SA-514 + 10 HK
790	4 AF17-53 + 12 SA-514 + 6 HK	869	4 AF17-54 + 16 SA-514 + 8 HK	948	4 AF17-55 + 20 SA-514 + 10 HK

### Corner shelving 600 mm

3 LEVELS		4 LEVELS		5 LEVELS	
SET Nº	SHELVING ITEMS BREAKDOWN	SET Nº	SHELVING ITEMS BREAKDOWN	SET Nº	SHELVING ITEMS BREAKDOWN
1500	1 AF17-63 + 3 SA-66 + 6 HK	1579	1 AF17-64 + 4 SA-66 + 8 HK	1658	1 AF17-65 + 5 SA-66 + 10 HK
1501	1 AF17-63 + 3 SA-67 + 6 HK	1580	1 AF17-64 + 4 SA-67 + 8 HK	1659	1 AF17-65 + 5 SA-67 + 10 HK
1502	1 AF17-63 + 3 SA-68 + 6 HK	1581	1 AF17-64 + 4 SA-68 + 8 HK	1660	1 AF17-65 + 5 SA-68 + 10 HK
1503	1 AF17-63 + 3 SA-69 + 6 HK	1582	1 AF17-64 + 4 SA-69 + 8 HK	1661	1 AF17-65 + 5 SA-69 + 10 HK
1504	1 AF17-63 + 3 SA-610 + 6 HK	1583	1 AF17-64 + 4 SA-610 + 8 HK	1662	1 AF17-65 + 5 SA-610 + 10 HK
1505	1 AF17-63 + 3 SA-611 + 6 HK	1584	1 AF17-64 + 4 SA-611 + 8 HK	1663	1 AF17-65 + 5 SA-611 + 10 HK
1506	1 AF17-63 + 3 SA-612 + 6 HK	1585	1 AF17-64 + 4 SA-612 + 8 HK	1664	1 AF17-65 + 5 SA-612 + 10 HK
1507	1 AF17-63 + 3 SA-613 + 6 HK	1586	1 AF17-64 + 4 SA-613 + 8 HK	1665	1 AF17-65 + 5 SA-613 + 10 HK
1508	1 AF17-63 + 3 SA-614 + 6 HK	1587	1 AF17-64 + 4 SA-614 + 8 HK	1666	1 AF17-65 + 5 SA-614 + 10 HK
1509	1 AF17-63 + 3 SA-615 + 6 HK	1588	1 AF17-64 + 4 SA-615 + 8 HK	1667	1 AF17-65 + 5 SA-615 + 10 HK
1510	1 AF17-63 + 3 SA-616 + 6 HK	1589	1 AF17-64 + 4 SA-616 + 8 HK	1668	1 AF17-65 + 5 SA-616 + 10 HK
1511	2 AF17-63 + 6 SA-68 + 6 HK	1590	2 AF17-64 + 8 SA-68 + 8 HK	1669	2 AF17-65 + 10 SA-68 + 10 HK
1512	2 AF17-63 + 3 SA-69 + 3 SA-68 + 6 HK	1591	2 AF17-64 + 4 SA-69 + 4 SA-68 + 8 HK	1670	2 AF17-65 + 5 SA-69 + 5 SA-68 + 10 HK
1513	2 AF17-63 + 6 SA-69 + 6 HK	1592	2 AF17-64 + 8 SA-69 + 8 HK	1671	2 AF17-65 + 10 SA-69 + 10 HK
1514	2 AF17-63 + 3 SA-69 + 3 SA-610 + 6 HK	1593	2 AF17-64 + 4 SA-69 + 4 SA-610 + 8 HK	1672	2 AF17-65 + 5 SA-69 + 5 SA-610 + 10 HK
1515	2 AF17-63 + 6 SA-610 + 6 HK	1594	2 AF17-64 + 8 SA-610 + 8 HK	1673	2 AF17-65 + 10 SA-610 + 10 HK
1516	2 AF17-63 + 3 SA-610 + 3 SA-611 + 6 HK	1595	2 AF17-64 + 4 SA-610 + 4 SA-611 + 8 HK	1674	2 AF17-65 + 5 SA-610 + 5 SA-611 + 10 HK
1517	2 AF17-63 + 6 SA-611 + 6 HK	1596	2 AF17-64 + 8 SA-611 + 8 HK	1675	2 AF17-65 + 10 SA-611 + 10 HK
1518	2 AF17-63 + 3 SA-611 + 3 SA-612 + 6 HK	1597	2 AF17-64 + 4 SA-611 + 4 SA-612 + 8 HK	1676	2 AF17-65 + 5 SA-611 + 5 SA-612 + 10 HK
1519	2 AF17-63 + 6 SA-612 + 6 HK	1598	2 AF17-64 + 8 SA-612 + 8 HK	1677	2 AF17-65 + 10 SA-612 + 10 HK
1520	2 AF17-63 + 3 SA-612 + 3 SA-613 + 6 HK	1599	2 AF17-64 + 4 SA-612 + 4 SA-613 + 8 HK	1678	2 AF17-65 + 5 SA-612 + 5 SA-613 + 10 HK
1521	2 AF17-63 + 6 SA-613 + 6 HK	1600	2 AF17-64 + 8 SA-613 + 8 HK	1679	2 AF17-65 + 10 SA-613 + 10 HK
1522	2 AF17-63 + 3 SA-613 + 3 SA-614 + 6 HK	1601	2 AF17-64 + 4 SA-613 + 4 SA-614 + 8 HK	1680	2 AF17-65 + 5 SA-613 + 5 SA-614 + 10 HK
1523	2 AF17-63 + 6 SA-614 + 6 HK	1602	2 AF17-64 + 8 SA-614 + 8 HK	1681	2 AF17-65 + 10 SA-614 + 10 HK
1524	2 AF17-63 + 3 SA-614 + 3 SA-615 + 6 HK	1603	2 AF17-64 + 4 SA-614 + 4 SA-615 + 8 HK	1682	2 AF17-65 + 5 SA-614 + 5 SA-615 + 10 HK
1525	2 AF17-63 + 6 SA-615 + 6 HK	1604	2 AF17-64 + 8 SA-615 + 8 HK	1683	2 AF17-65 + 10 SA-615 + 10 HK
1526	2 AF17-63 + 3 SA-615 + 3 SA-616 + 6 HK	1605	2 AF17-64 + 4 SA-615 + 4 SA-616 + 8 HK	1684	2 AF17-65 + 5 SA-615 + 5 SA-616 + 10 HK
1527	2 AF17-63 + 6 SA-616 + 6 HK	1606	2 AF17-64 + 8 SA-616 + 8 HK	1685	2 AF17-65 + 10 SA-616 + 10 HK
1528	3 AF17-63 + 3 SA-610 + 6 SA-611 + 6 HK	1607	3 AF17-64 + 4 SA-610 + 8 SA-611 + 8 HK	1686	3 AF17-65 + 5 SA-610 + 10 SA-611 + 10 HK
1529	3 AF17-63 + 9 SA-611 + 6 HK	1608	3 AF17-64 + 12 SA-611 + 8 HK	1687	3 AF17-65 + 15 SA-611 + 10 HK
1530	3 AF17-63 + 6 SA-611 + 3 SA-612 + 6 HK	1609	3 AF17-64 + 8 SA-611 + 4 SA-612 + 8 HK	1688	3 AF17-65 + 10 SA-611 + 5 SA-612 + 10 HK
1531	3 AF17-63 + 3 SA-611 + 6 SA-612 + 6 HK	1610	3 AF17-64 + 4 SA-611 + 8 SA-612 + 8 HK	1689	3 AF17-65 + 5 SA-611 + 10 SA-612 + 10 HK
1532	3 AF17-63 + 9 SA-612 + 6 HK	1611	3 AF17-64 + 12 SA-612 + 8 HK	1690	3 AF17-65 + 15 SA-612 + 10 HK
1533	3 AF17-63 + 6 SA-612 + 3 SA-613 + 6 HK	1612	3 AF17-64 + 8 SA-612 + 4 SA-613 + 8 HK	1691	3 AF17-65 + 10 SA-612 + 5 SA-613 + 10 HK
1534	3 AF17-63 + 3 SA-612 + 6 SA-613 + 6 HK	1613	3 AF17-64 + 4 SA-612 + 8 SA-613 + 8 HK	1692	3 AF17-65 + 5 SA-612 + 10 SA-613 + 10 HK
1535	3 AF17-63 + 9 SA-613 + 6 HK	1614	3 AF17-64 + 12 SA-613 + 8 HK	1693	3 AF17-65 + 15 SA-613 + 10 HK
1536	3 AF17-63 + 6 SA-613 + 3 SA-614 + 6 HK	1615	3 AF17-64 + 8 SA-613 + 4 SA-614 + 8 HK	1694	3 AF17-65 + 10 SA-613 + 5 SA-614 + 10 HK
1537	3 AF17-63 + 3 SA-613 + 6 SA-614 + 6 HK	1616	3 AF17-64 + 4 SA-613 + 8 SA-614 + 8 HK	1695	3 AF17-65 + 5 SA-613 + 10 SA-614 + 10 HK
1538	3 AF17-63 + 9 SA-614 + 6 HK	1617	3 AF17-64 + 12 SA-614 + 8 HK	1696	3 AF17-65 + 15 SA-614 + 10 HK
1539	3 AF17-63 + 6 SA-614 + 3 SA-615 + 6 HK	1618	3 AF17-64 + 8 SA-614 + 4 SA-615 + 8 HK	1697	3 AF17-65 + 10 SA-614 + 5 SA-615 + 10 HK
1540	3 AF17-63 + 3 SA-614 + 6 SA-615 + 6 HK	1619	3 AF17-64 + 4 SA-614 + 8 SA-615 + 8 HK	1698	3 AF17-65 + 5 SA-614 + 10 SA-615 + 10 HK
1541	3 AF17-63 + 9 SA-615 + 6 HK	1620	3 AF17-64 + 12 SA-615 + 8 HK	1699	3 AF17-65 + 15 SA-615 + 10 HK
1542	3 AF17-63 + 6 SA-615 + 3 SA-616 + 6 HK	1621	3 AF17-64 + 8 SA-615 + 4 SA-616 + 8 HK	1700	3 AF17-65 + 10 SA-615 + 5 SA-616 + 10 HK
1543	3 AF17-63 + 3 SA-615 + 6 SA-616 + 6 HK	1622	3 AF17-64 + 4 SA-615 + 8 SA-616 + 8 HK	1701	3 AF17-65 + 5 SA-615 + 10 SA-616 + 10 HK
1544	3 AF17-63 + 9 SA-616 + 6 HK	1623	3 AF17-64 + 12 SA-616 + 8 HK	1702	3 AF17-65 + 15 SA-616 + 10 HK
1545	4 AF17-63 + 12 SA-612 + 6 HK	1624	4 AF17-64 + 16 SA-612 + 8 HK	1703	4 AF17-65 + 20 SA-612 + 10 HK
1546	4 AF17-63 + 9 SA-612 + 3 SA-613 + 6 HK	1625	4 AF17-64 + 12 SA-612 + 4 SA-613 + 8 HK	1704	4 AF17-65 + 15 SA-612 + 5 SA-613 + 10 HK
1547	4 AF17-63 + 6 SA-612 + 6 SA-613 + 6 HK	1626	4 AF17-64 + 8 SA-612 + 8 SA-613 + 8 HK	1705	4 AF17-65 + 10 SA-612 + 10 SA-613 + 10 HK
1548	4 AF17-63 + 3 SA-612 + 9 SA-613 + 6 HK	1627	4 AF17-64 + 4 SA-612 + 12 SA-613 + 8 HK	1706	4 AF17-65 + 5 SA-612 + 15 SA-613 + 10 HK
1549	4 AF17-63 +				



Extraction



# Extraction hoods

Hoods for cooking blocks .....	521
— Central with plenum .....	523
— Wall-type with plenum .....	524
— Central compensating .....	525
— Wall-type compensating .....	526
Inverted hoods .....	527
— Wall-type with plenum .....	528
Steam hoods .....	529
Buffet hoods .....	531
— With plenum .....	532
— Compensating .....	532



Extract the most out of your kitchen



Access the website



## Hoods for cooking blocks



- Extraction hood specially designed to be installed in high-performance professional kitchens to suck out steam, odors, grease and heat generated in cooking and food processing operations.
- Made of stainless steel with satin finish.
- Accessible parts and edges in bent sheet metal to make cleaning easier and avoid cuts when handling.
- Extraction capacity maximized thanks to casing design and hood profile.
- Models larger than 2.20 meters (except 2.5 m model that comes in a single piece) are supplied in several pieces with a hidden joining kit, easy to assemble.
- Hermetically closed, solid and robust structure, eliminating the risk of dripping fat and escaping fumes.
- Guided grease drain system. Collection tray and drain hole for evacuation.
- 490x490x50 mm stainless steel slat filters.
- Interior plenum with independent flow regulation flaps for each filter.
- Models available with compensated air supply system, integrated into the hood, to prevent air flow falling directly on the chefs. Two external ventilation units, one for internal air extraction and the other for external air supply.

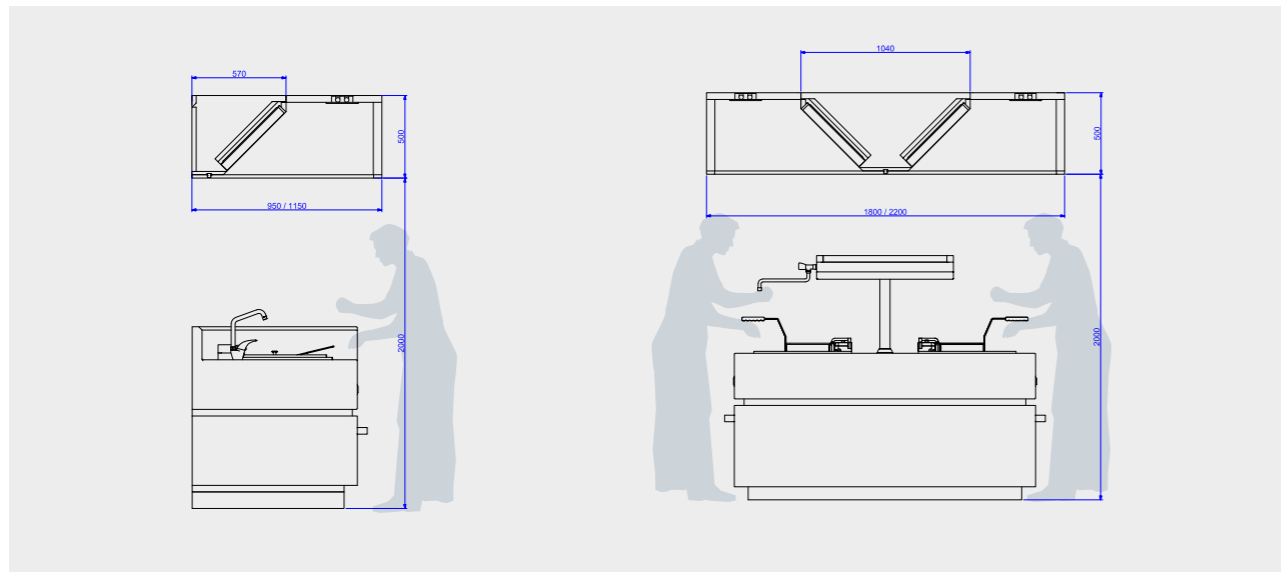

# Central with plenum

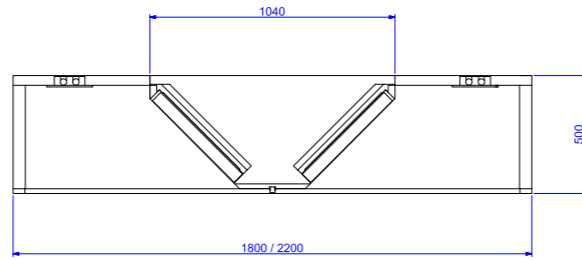

LENGTH (mm)	NO. FILTERS	1800 mm WIDTH			2200 mm WIDTH			LENGTH (mm)	NO. FILTERS	1800 mm WIDTH			2200 mm WIDTH		
		MODEL EHBPC	CODE	€	MODEL EHBPC	CODE	€			MODEL EHBPC	CODE	€	MODEL EHBPC	CODE	€
1200	4	120180	19083377	-	120220	19084046	-	4000	12	400180	19083409	-	400220	19083473	-
1200	4	120180-L	19083378	-	120220-L	19084047	-	4000	12	400180-L	19083410	-	400220-L	19083474	-
1500	4	150180	19083379	-	150220	19083443	-	4200	14	420180	19083411	-	420220	19083475	-
1500	4	150180-L	19083380	-	150220-L	19083444	-	4200	14	420180-L	19083412	-	420220-L	19083476	-
1700	6	170180	19083381	-	170220	19083445	-	4400	16	440180	19083413	-	440220	19083477	-
1700	6	170180-L	19083382	-	170220-L	19083446	-	4400	16	440180-L	19083414	-	440220-L	19083478	-
2000	6	200180	19083383	-	200220	19084048	-	4500	14	450180	19083415	-	450220	19083479	-
2000	6	200180-L	19083384	-	200220-L	19084049	-	4500	14	450180-L	19083416	-	450220-L	19083480	-
2200	8	220180	19083385	-	220220	19084050	-	4600	16	460180	19083417	-	460220	19084054	-
2200	8	220180-L	19083386	-	220220-L	19084051	-	4600	16	460180-L	19083418	-	460220-L	19084055	-
2400	8	240180	19083387	-	240220	19083451	-	4700	16	470180	19083419	-	470220	19083483	-
2400	8	240180-L	19083388	-	240220-L	19083452	-	4700	16	470180-L	19083420	-	470220-L	19083484	-
2500	8	250180	19083389	-	250220	19083453	-	4900	16	490180	19083421	-	490220	19083485	-
2500	8	250180-L	19083390	-	250220-L	19083454	-	4900	16	490180-L	19083422	-	490220-L	19083486	-
2700	8	270180	19083391	-	270220	19083455	-	5000	16	500180	19083423	-	500220	19083487	-
2700	8	270180-L	19083392	-	270220-L	19083456	-	5000	16	500180-L	19083424	-	500220-L	19083488	-
2900	10	290180	19083393	-	290220	19083457	-	5100	18	510180	19083425	-	510220	19083489	-
2900	10	290180-L	19083394	-	290220-L	19083458	-	5100	18	510180-L	19083426	-	510220-L	19083490	-
3000	8	300180	19083395	-	300220	19083459	-	5200	16	520180	19083427	-	520220	19084056	-
3000	8	300180-L	19083396	-	300220-L	19083460	-	5200	16	520180-L	19083428	-	520220-L	19084057	-
3200	10	320180	19083397	-	320220	19083461	-	5400	18	540180	19083429	-	540220	19084058	-
3200	10	320180-L	19083398	-	320220-L	19083462	-	5400	18	540180-L	19083430	-	540220-L	19084059	-
3400	12	340180	19083399	-	340220	19083463	-	5500	16	550180	19083431	-	550220	19084060	-
3400	12	340180-L	19083400	-	340220-L	19083464	-	5500	16	550180-L	19083432	-	550220-L	19084061	-
3500	10	350180	19083401	-	350220	19083465	-	5600	20	560180	19083433	-	560220	19084062	-
3500	10	350180-L	19083402	-	350220-L	19083466	-	5600	20	560180-L	19083434	-	560220-L	19084063	-
3600	12	360180	19083403	-	360220	19084052	-	5700	18	570180	19083435	-	570220	19084064	-
3600	12	360180-L	19083404	-	360220-L	19084053	-	5700	18	570180-L	19083436	-	570220-L	19084065	-
3700	12	370180	19083405	-	370220	19083469	-	5900	20	590180	19083437	-	590220	19084066	-
3700	12	370180-L	19083406	-	370220-L	19083470	-	5900	20	590180-L	19083438	-	590220-L	19084067	-
3900	14	390180	19083407	-	390220	19083471	-	6000	18	600180	19083439	-	600220	19084068	-
3900	14	390180-L	19083408	-	390220-L	19083472	-	6000	18	600180-L	19083440	-	600220-L	19084069	-

• -L: With LED lighting

# Wall-type with plenum

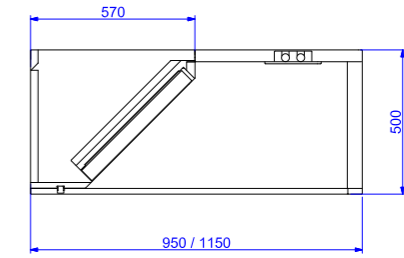

LENGTH (mm)	NO. FILTERS	950 mm WIDTH			1150 mm WIDTH			LENGTH (mm)	NO. FILTERS	950 mm WIDTH			1150 mm WIDTH		
		MODEL EHPW	CODE	€	MODEL EHPW	CODE	€			MODEL EHPW	CODE	€	MODEL EHPW	CODE	€
1200	2	120950	19082439	-	120115	19083313	-	4000	6	400950	19083281	-	400115	19083345	-
1200	2	120950-L	19083250	-	120115-L	19083314	-	4000	6	400950-L	19083282	-	400115-L	19083346	-
1500	2	150950	19083216	-	150115	19084016	-	4200	7	420950	19083283	-	420115	19083347	-
1500	2	150950-L	19083217	-	150115-L	19084017	-	4200	7	420950-L	19083284	-	420115-L	19083348	-
1700	3	170950	19083218	-	170115	19084018	-	4400	8	440950	19083285	-	440115	19083349	-
1700	3	170950-L	19083219	-	170115-L	19084019	-	4400	8	440950-L	19083286	-	440115-L	19083350	-
2000	3	200950	19083255	-	200115	19083319	-	4500	7	450950	19084002	-	450115	19084032	-
2000	3	200950-L	19083256	-	200115-L	19083320	-	4500	7	450950-L	19084003	-	450115-L	19084033	-
2200	4	220950	19083257	-	220115	19083321	-	4600	8	460950	19083289	-	460115	19083353	-
2200	4	220950-L	19083258	-	220115-L	19083322	-	4600	8	460950-L	19083290	-	460115-L	19083354	-
2400	4	240950	19083259	-	240115	19083323	-	4700	8	470950	19084004	-	470115	19084034	-
2400	4	240950-L	19083260	-	240115-L	19083324	-	4700	8	470950-L	19084005	-	470115-L	19084035	-
2500	4	250950	19083990	-	250115	19084020	-	4900	8	490950	19084006	-	490115	19084036	-
2500	4	250950-L	19083991	-	250115-L	19084021	-	4900	8	490950-L	19084007	-	490115-L	19084037	-
2700	4	270950	19083992	-	270115	19084022	-	5000	8	500950	19083295	-	500115	19083359	-
2700	4	270950-L	19083993	-	270115-L	19084023	-	5000	8	500950-L	19083296	-	500115-L	19083360	-
2900	5	290950	19083994	-	290115	19084024	-	5100	9	510950	19084008	-	510115	19084038	-
2900	5	290950-L	19083995	-	290115-L	19084025	-	5100	9	510950-L	19084009	-	510115-L	19084039	-
3000	4	300950	19083267	-	300115	19083331	-	5200	8	520950	19083299	-	520115	19083363	-
3000	4	300950-L	19083268	-	300115-L	19083332	-	5200	8	520950-L	19083300	-	520115-L	19083364	-
3200	5	320950	19083269	-	320115	19083333	-	5400	9	540950	19083301	-	540115	19083365	-
3200	5	320950-L	19083270	-	320115-L	19083334	-	5400	9	540950-L	19083302	-	540115-L	19083366	-
3400	6	340950	19083271	-	340115	19083335	-	5500	8	550950	19084010	-	550115	19084040	-
3400	6	340950-L	19083272	-	340115-L	19083336	-	5500	8	550950-L	19084011	-	550115-L	19084041	-
3500	5	350950	19083996	-	350115	19084026	-	5600	10	560950	19083305	-	560115	19083369	-
3500	5	350950-L	19083997	-	350115-L	19084027	-	5600	10	560950-L	19083306	-	560115-L	19083370	-
3600	6	360950	19083275	-	360115	19083339	-	5700	9	570950	19084012	-	570115	19084042	-
3600	6	360950-L	19083276	-	360115-L	19083340	-	5700	9	570950-L	19084013	-	570115-L	19084043	-
3700	6	370950	19083998	-	370115	19084028	-	5900	10	590950	19084014	-	590115	19084044	-
3700	6	370950-L	19083999	-	370115-L	19084029	-	5900	10	590950-L	19084015	-	590115-L	19084045	-
3900	7	390950	19084000	-	390115	19084030	-	6000	9	600950	19083311	-	600115	19083375	-
3900	7	390950-L	19084001	-	390115-L	19084031	-	6000	9	600950-L	19083312	-	600115-L	19083376	-

• -L: With LED lighting

## Central compensating

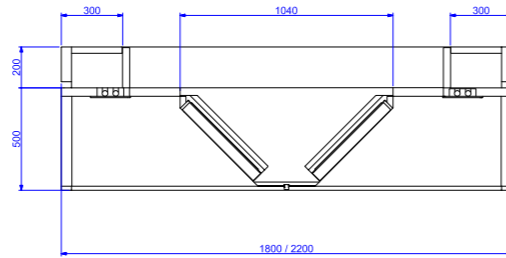

LENGTH (mm)	NO. FILTERS	1800 mm WIDTH			2200 mm WIDTH			LENGTH (mm)	NO. FILTERS	1800 mm WIDTH			2200 mm WIDTH		
		MODEL EHBCCOC	CODE	€	MODEL EHBCCOC	CODE	€			MODEL EHBCCOC	CODE	€	MODEL EHBCCOC	CODE	€
1200	4	120180	19083633	-	120220	19083697	-	4000	12	400180	19083665	-	400220	19083729	-
1200	4	120180-L	19083634	-	120220-L	19083698	-	4000	12	400180-L	19083666	-	400220-L	19083730	-
1500	4	150180	19083635	-	150220	19083699	-	4200	14	420180	19083667	-	420220	19083731	-
1500	4	150180-L	19083636	-	150220-L	19083700	-	4200	14	420180-L	19083668	-	420220-L	19083732	-
1700	6	170180	19083637	-	170220	19083701	-	4400	16	440180	19083669	-	440220	19083733	-
1700	6	170180-L	19083638	-	170220-L	19083702	-	4400	16	440180-L	19083670	-	440220-L	19083734	-
2000	6	200180	19083639	-	200220	19083703	-	4500	14	450180	19083671	-	450220	19083735	-
2000	6	200180-L	19083640	-	200220-L	19083704	-	4500	14	450180-L	19083672	-	450220-L	19083736	-
2200	8	220180	19083641	-	220220	19083705	-	4600	16	460180	19083673	-	460220	19083737	-
2200	8	220180-L	19083642	-	220220-L	19083706	-	4600	16	460180-L	19083674	-	460220-L	19083738	-
2400	8	240180	19083643	-	240220	19083707	-	4700	16	470180	19083675	-	470220	19083739	-
2400	8	240180-L	19083644	-	240220-L	19083708	-	4700	16	470180-L	19083676	-	470220-L	19083740	-
2500	8	250180	19083645	-	250220	19083709	-	4900	16	490180	19083677	-	490220	19083741	-
2500	8	250180-L	19083646	-	250220-L	19083710	-	4900	16	490180-L	19083678	-	490220-L	19083742	-
2700	8	270180	19083647	-	270220	19083711	-	5000	16	500180	19083679	-	500220	19083743	-
2700	8	270180-L	19083648	-	270220-L	19083712	-	5000	16	500180-L	19083680	-	500220-L	19083744	-
2900	10	290180	19083649	-	290220	19083713	-	5100	18	510180	19083681	-	510220	19083745	-
2900	10	290180-L	19083650	-	290220-L	19083714	-	5100	18	510180-L	19083682	-	510220-L	19083746	-
3000	8	300180	19083651	-	300220	19083715	-	5200	16	520180	19083683	-	520220	19083747	-
3000	8	300180-L	19083652	-	300220-L	19083716	-	5200	16	520180-L	19083684	-	520220-L	19083748	-
3200	10	320180	19083653	-	320220	19083717	-	5400	18	540180	19083685	-	540220	19083749	-
3200	10	320180-L	19083654	-	320220-L	19083718	-	5400	18	540180-L	19083686	-	540220-L	19083750	-
3400	12	340180	19083655	-	340220	19083719	-	5500	16	550180	19083687	-	550220	19083751	-
3400	12	340180-L	19083656	-	340220-L	19083720	-	5500	16	550180-L	19083688	-	550220-L	19083752	-
3500	10	350180	19083657	-	350220	19083721	-	5600	20	560180	19083689	-	560220	19083753	-
3500	10	350180-L	19083658	-	350220-L	19083722	-	5600	20	560180-L	19083690	-	560220-L	19083754	-
3600	12	360180	19083659	-	360220	19083723	-	5700	18	570180	19083691	-	570220	19083755	-
3600	12	360180-L	19083660	-	360220-L	19083724	-	5700	18	570180-L	19083692	-	570220-L	19083756	-
3700	12	370180	19083661	-	370220	19083725	-	5900	20	590180	19083693	-	590220	19083757	-
3700	12	370180-L	19083662	-	370220-L	19083726	-	5900	20	590180-L	19083694	-	590220-L	19083758	-
3900	14	390180	19083663	-	390220	19083727	-	6000	18	600180	19083695	-	600220	19083759	-
3900	14	390180-L	19083664	-	390220-L	19083728	-	6000	18	600180-L	19083696	-	600220-L	19083760	-

• -L: With LED lighting

## Wall-type compensating

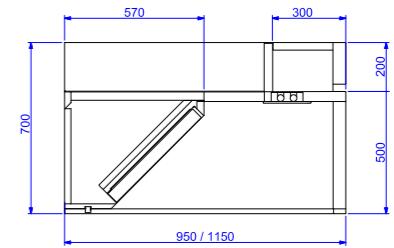

LENGTH (mm)	NO. FILTERS	950 mm WIDTH			1150 mm WIDTH			LENGTH (mm)	NO. FILTERS	950 mm WIDTH			1150 mm WIDTH		
		MODEL EHBCCOW	CODE	€	MODEL EHBCCOW	CODE	€			MODEL EHBCCOW	CODE	€	MODEL EHBCCOW	CODE	€
1200	2	120950	19083505	-	120115	19083569	-	4000	6	400950	19083537	-	400115	19083601	-
1200	2	120950-L	19083506	-	120115-L	19083570	-	4000	6	400950-L	19083538	-	400115-L	19083602	-
1500	2	150950	19084070	-	150115	19084100	-	4200	7	420950	19083539	-	420115	19083603	-
1500	2	150950-L	19084071	-	150115-L	19084101	-	4200	7	420950-L	19083540	-	420115-L	19083604	-
1700	3	170950	19084072	-	170115	19084102	-	4400	8	440950	19083541	-	440115	19083605	-
1700	3	170950-L	19084073	-	170115-L	19084103	-	4400	8	440950-L	19083542	-	440115-L	19083606	-
2000	3	200950	19083511	-	200115	19083575	-	4500	7	450950	19084086	-	450115	19084116	-
2000	3	200950-L	19083512	-	200115-L	19083576	-	4500	7	450950-L	19084087	-	450115-L	19084117	-
2200	4	220950	19083513	-	220115	19083577	-	4600	8	460950	19083545	-	460115	19083609	-
2200	4	220950-L	19083514	-	220115-L	19083578	-	4600	8	460950-L	19083546	-	460115-L	19083610	-
2400	4	240950	19083515	-	240115	19083579	-	4700	8	470950	19084088	-	470115	19084118	-
2400	4	240950-L	19083516	-	240115-L	19083580	-	4700	8	470950-L	19084089	-	470115-L	19084119	-
2500	4	250950	19084074	-	250115	19084104	-	4900	8	490950	19084090	-	490115	19084120	-
2500	4	250950-L	19084075	-	250115-L	19084105	-	4900	8	490950-L	19084091	-	490115-L	19084121	-
2700	4	270950	19084076	-	270115	19084106	-	5000	8	500950	19083551	-	500115	19083615	-
2700	4	270950-L	19084077	-	270115-L	19084107	-	5000	8	500950-L	19083552	-	500115-L	19083616	-
2900	5	290950	19084078	-	290115	19084108	-	5100	9	510950	19084092	-	510115	19084122	-
2900	5	290950-L	19084079	-	290115-L	19084109	-	5100	9	510950-L	19084093	-	510115-L	19084123	-
3000	4	300950	19083523	-	300115	19083587	-	5200	8	520950	19083555	-	520115	19083619	-
3000	4	300950-L	19083524	-	300115-L	19083588	-	5200	8	520950-L	19083556	-	520115-L	19083620	-
3200	5	320950	19083525	-	320115	19083589	-	5400	9	540950	19083557	-	540115	19083621	-
3200	5	320950-L	19083526	-	320115-L	19083590	-	5400	9	540950-L	19083558	-	540115-L	19083622	-
3400	6	340950	19083527	-	340115	19083591	-	5500	8	550950	19084094	-	550115	19084124	-
3400	6	340950-L	19083528	-	340115-L	19083592	-	5500	8	550950-L	19084095	-	550115-L	19084125	-
3500	5	350950	19084080	-	350115	19084110	-	5600	10	560950	19083561	-	560115	19083625	-
3500	5	350950-L	19084081	-	350115-L	19084111	-	5600	10	560950-L	19083562	-	560115-L	19083626	-
3600	6	360950	19083531	-	360115	19083595	-	5700	9	570950	19084096	-	570115	19084126	-
3600	6	360950-L	19083532	-	360115-L	19083596	-	5700	9	570950-L	19084097	-	570115-L	19084127	-
3700	6	370950	19084082	-	370115	19084112	-	5900	10	590950	19084098	-	590115	19084128	-
3700	6	370950-L	19084083	-	370115-L	19084113	-	5900	10	590950-L	19084099	-	590115-L	19084129	-
3900	7	390950	19084084	-	390115	19084114	-	6000	9	600950	19083567	-	600115	19083631	-
3900	7	390950-L	19084085	-	390115-L	19084115	-	6000	9	600950-L	19083568	-	600115-L	19083632	-

• -L: With LED lighting



## Inverted hoods



- Extraction hood specially designed to be installed in high-performance professional kitchens to suck out steam, odors, grease and heat generated in cooking and food processing operations.
- Inverted extraction ideal for ovens. Filter arrangement on the front that facilitate the absorption of steam generated during cooking and exposed when oven door is opened. Also recommended for large depth cooking surfaces or high temperature cooking.
- Made of stainless steel with satin finish.
- Accessible parts and edges in bent sheet metal to make cleaning easier and avoid cuts when handling.
- Extraction capacity maximized thanks to casing design and hood profile.

- Models larger than 2.20 meters (except 2.5 m model that comes in a single piece) are supplied in several pieces with a hidden joining kit, easy to assemble.
- Hermetically closed, solid and robust structure, eliminating the risk of dripping fat and escaping fumes.
- Guided grease drain system. Collection tray and drain hole for evacuation.
- 490x490x50 mm stainless steel slat filters.
- Interior plenum with independent flow regulation flaps for each filter.



## Wall-type with plenum

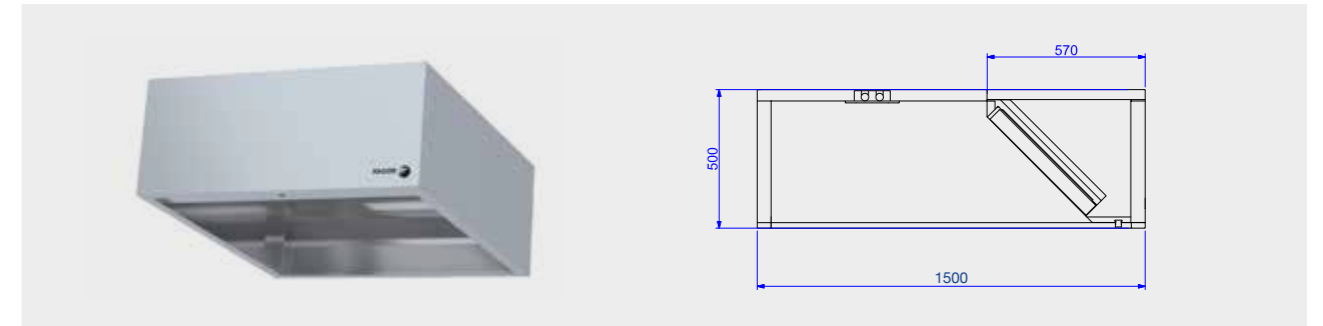

### 1500 mm width

MODEL	CODE	LENGTH (mm)	NO. FILTERS	€
EHBINVPW120150	19095446	1200	2	-
EHBINVPW120150-L	19095447	1200	2	-
EHBINVPW150150	19095448	1500	2	-
EHBINVPW150150-L	19095449	1500	2	-
EHBINVPW170150	19095450	1700	3	-
EHBINVPW170150-L	19095451	1700	3	-
EHBINVPW200150	19095452	2000	3	-
EHBINVPW200150-L	19095453	2000	3	-
EHBINVPW220150	19095454	2200	4	-
EHBINVPW220150-L	19095455	2200	4	-
EHBINVPW240150	19095456	2400	4	-
EHBINVPW240150-L	19095457	2400	4	-
EHBINVPW250150	19095458	2500	4	-
EHBINVPW250150-L	19095459	2500	4	-
EHBINVPW270150	19095460	2700	4	-
EHBINVPW270150-L	19095461	2700	4	-
EHBINVPW290150	19095462	2900	5	-
EHBINVPW290150-L	19095463	2900	5	-
EHBINVPW300150	19095464	3000	4	-
EHBINVPW300150-L	19095465	3000	4	-
EHBINVPW320150	19095466	3200	5	-
EHBINVPW320150-L	19095467	3200	5	-
EHBINVPW340150	19095468	3400	6	-
EHBINVPW340150-L	19095469	3400	6	-
EHBINVPW350150	19095470	3500	5	-
EHBINVPW350150-L	19095471	3500	5	-
EHBINVPW360150	19095472	3600	6	-
EHBINVPW360150-L	19095473	3600	6	-
EHBINVPW370150	19095474	3700	6	-
EHBINVPW370150-L	19095475	3700	6	-
EHBINVPW390150	19095476	3900	7	-
EHBINVPW390150-L	19095477	3900	7	-

- L: With LED lighting

MODEL	CODE	LENGTH (mm)	NO. FILTERS	€
EHBINVPW400150	19095478	4000	6	-
EHBINVPW400150-L	19095479	4000	6	-
EHBINVPW420150	19095480	4200	7	-
EHBINVPW420150-L	19095481	4200	7	-
EHBINVPW440150	19095482	4400	8	-
EHBINVPW440150-L	19095483	4400	8	-
EHBINVPW450150	19095484	4500	7	-
EHBINVPW450150-L	19095485	4500	7	-
EHBINVPW460150	19095486	4600	8	-
EHBINVPW460150-L	19095487	4600	8	-
EHBINVPW470150	19095488	4700	8	-
EHBINVPW470150-L	19095489	4700	8	-
EHBINVPW490150	19095490	4900	8	-
EHBINVPW490150-L	19095491	4900	8	-
EHBINVPW500150	19095492	5000	8	-
EHBINVPW500150-L	19095493	5000	8	-
EHBINVPW510150	19095494	5100	9	-
EHBINVPW510150-L	19095495	5100	9	-
EHBINVPW520150	19095496	5200	8	-
EHBINVPW520150-L	19095497	5200	8	-
EHBINVPW540150	19095498	5400	9	-
EHBINVPW540150-L	19095499	5400	9	-
EHBINVPW550150	19095500	5500	8	-
EHBINVPW550150-L	19095501	5500	8	-
EHBINVPW560150	19095502	5600	10	-
EHBINVPW560150-L	19095503	5600	10	-
EHBINVPW570150	19095504	5700	9	-
EHBINVPW570150-L	19095505	5700	9	-
EHBINVPW590150	19095506	5900	10	-
EHBINVPW590150-L	19095507	5900	10	-
EHBINVPW600150	19095508	6000	9	-
EHBINVPW600150-L	19095509	6000	9	-



## Steam hoods

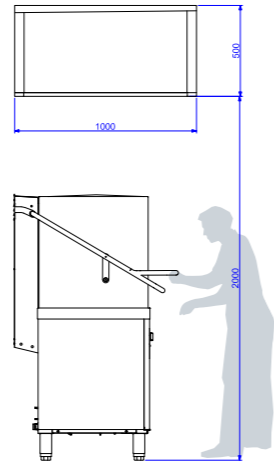

- Extraction hood specially designed to be installed in high-performance professional kitchens to suck out steam and heat generated in ware washing operations.
- Made of stainless steel with satin finish.
- Accessible parts and edges in bent sheet metal to make cleaning easier and avoid cuts when handling.
- Extraction capacity maximized thanks to casing design and hood profile.

### 1000 mm width

MODEL	CODE	LENGTH (mm)	€
EHBVW100100	19083825	1000	-
EHBVW120100	19083826	1200	-
EHBVW150100	19083827	1500	-
EHBVW170100	19083828	1700	-
EHBVW200100	19083829	2000	-
EHBVW220100	19083830	2200	-
EHBVW240100	19083831	2400	-
EHBVW250100	19083832	2500	-
EHBVW270100	19083833	2700	-
EHBVW290100	19083834	2900	-
EHBVW300100	19083835	3000	-
EHBVW320100	19083836	3200	-
EHBVW340100	19083837	3400	-
EHBVW360100	19083838	3600	-
EHBVW370100	19083839	3700	-
EHBVW390100	19083840	3900	-

- Models larger than 2.20 meters (except 2.5 m model that comes in a single piece) are supplied in several pieces with a hidden joining kit, easy to assemble.
- Hermetically closed, solid and robust structure, eliminating the risk of escaping fumes.
- Interior roof with slight inclination to guide condensations.

MODEL	CODE	LENGTH (mm)	€
EHBVW400100	19083841	4000	-
EHBVW420100	19083842	4200	-
EHBVW440100	19083843	4400	-
EHBVW450100	19083844	4500	-
EHBVW460100	19083845	4600	-
EHBVW470100	19083846	4700	-
EHBVW490100	19083847	4900	-
EHBVW500100	19083848	5000	-
EHBVW510100	19083849	5100	-
EHBVW520100	19083850	5200	-
EHBVW540100	19083851	5400	-
EHBVW550100	19083852	5500	-
EHBVW560100	19083853	5600	-
EHBVW570100	19083854	5700	-
EHBVW590100	19083855	5900	-
EHBVW600100	19083856	6000	-



# Buffet hoods



- Extraction hood specially designed to be installed in buffet areas to suck out steam, odors, grease and heat generated in show cooking stations.
- Made of stainless steel with satin finish.
- Accessible parts and edges in bent sheet metal to make cleaning easier and avoid cuts when handling.
- Extraction capacity maximized thanks to casing design and hood profile.
- Models larger than 2.20 meters (except 2.5 m model that comes in a single piece) are supplied in several pieces with a hidden joining kit, easy to assemble.

- Hermetically closed, solid and robust structure, eliminating the risk of dripping fat and escaping fumes.
- Guided grease drain system. Collection tray and drain hole for evacuation.
- 490x490x50 mm stainless steel slat filters.
- Interior plenum with independent flow regulation flaps for each filter.
- Models available with compensated air supply system, integrated into the hood, to prevent air flow falling directly on the chefs. Two external ventilation units, one for internal air extraction and the other for external air supply.

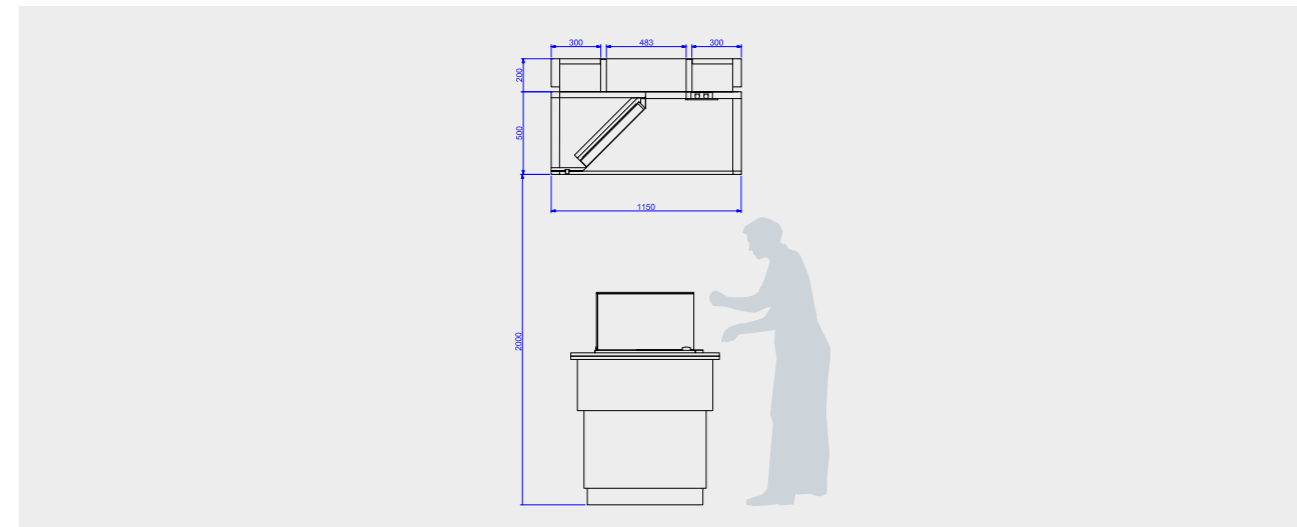

# With plenum and compensating

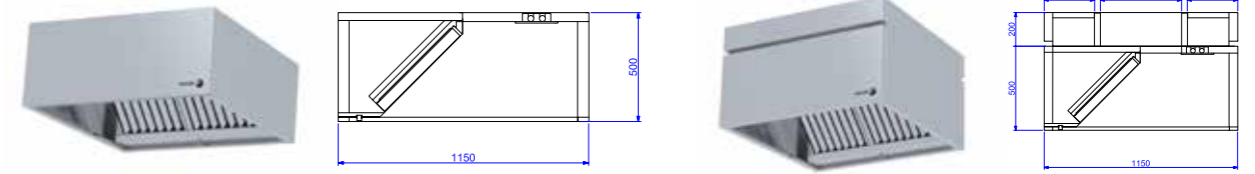

## 1150 mm width

LENGTH (mm)	NO. FILTERS	WITH PLENUM			COMPENSATING			LENGTH (mm)	NO. FILTERS	WITH PLENUM			COMPENSATING		
		MODEL EHBPB	CODE	€	MODEL EHBCOB	CODE	€			MODEL EHBPB	CODE	€	MODEL EHBCOB	CODE	€
1200	2	120115	19083857	-	120115	19083921	-	4000	6	400115	19083889	-	400115	19083953	-
1200	2	120115-L	19083858	-	120115-L	19083922	-	4000	6	400115-L	19083890	-	400115-L	19083954	-
1500	2	150115	19084130	-	150115	19084160	-	4200	7	420115	19083891	-	420115	19083955	-
1500	2	150115-L	19084131	-	150115-L	19084161	-	4200	7	420115-L	19083892	-	420115-L	19083956	-
1700	3	170115	19084132	-	170115	19084162	-	4400	8	440115	19083893	-	440115	19083957	-
1700	3	170115-L	19084133	-	170115-L	19084163	-	4400	8	440115-L	19083894	-	440115-L	19083958	-
2000	3	200115	19083863	-	200115	19083927	-	4500	7	450115	19084146	-	450115	19084176	-
2000	3	200115-L	19083864	-	200115-L	19083928	-	4500	7	450115-L	19084147	-	450115-L	19084177	-
2200	4	220115	19083865	-	220115	19083929	-	4600	8	460115	19083897	-	460115	19083961	-
2200	4	220115-L	19083866	-	220115-L	19083930	-	4600	8	460115-L	19083898	-	460115-L	19083962	-
2400	4	240115	19083867	-	240115	19083931	-	4700	8	470115	19084148	-	470115	19084178	-
2400	4	240115-L	19083868	-	240115-L	19083932	-	4700	8	470115-L	19084149	-	470115-L	19084179	-
2500	4	250115	19084134	-	250115	19084164	-	4900	8	490115	19084150	-	490115	19084180	-
2500	4	250115-L	19084135	-	250115-L	19084165	-	4900	8	490115-L	19084151	-	490115-L	19084181	-
2700	4	270115	19084136	-	270115	19084166	-	5000	8	500115	19083903	-	500115	19083967	-
2700	4	270115-L	19084137	-	270115-L	19084167	-	5000	8	500115-L	19083904	-	500115-L	19083968	-
2900	5	290115	19084138	-	290115	19084168	-	5100	9	510115	19084152	-	510115	19084182	-
2900	5	290115-L	19084139	-	290115-L	19084169	-	5100	9	510115-L	19084153	-	510115-L	19084183	-
3000	4	300115	19083875	-	300115	19083939	-	5200	8	520115	19083907	-	520115	19083971	-
3000	4	300115-L	19083876	-	300115-L	19083940	-	5200	8	520115-L	19083908	-	520115-L	19083972	-
3200	5	320115	19083877	-	320115	19083941	-	5400	9	540115	19083909	-	540115	19083973	-
3200	5	320115-L	19083878	-	320115-L	19083942	-	5400	9	540115-L	19083910	-	540115-L	19083974	-
3400	6	340115	19083879	-	340115	19083943	-	5500	8	550115	19084154	-	550115	19084184	-
3400	6	340115-L	19083880	-	340115-L	19083944	-	5500	8	550115-L	19084155	-	550115-L	19084185	-
3500	5	350115	19084140	-	350115	19084170	-	5600	10	560115	19083913	-	560115	19083977	-
3500	5	350115-L	19084141	-	350115-L	19084171	-	5600	10	560115-L	19083914	-	560115-L	19083978	-
3600	6	360115	19083883	-	360115	19083947	-	5700	9	570115	19084156	-	570115	19084186	-
3600	6	360115-L	19083884	-	360115-L	19083948	-	5700	9	570115-L	19084157	-	570115-L	19084187	-
3700	6	370115	19084142	-	370115	19084172	-	5900	10	590115	19084158	-	590115	19084188	-
3700	6	370115-L	19084143	-	370115-L	19084173	-	5900	10	590115-L	19084159	-	590115-L	19084189	-
3900	7	390115	19084144	-	390115	19084174	-	6000	9	600115	19083919	-	600115	19083983	-
3900	7	390115-L	19084145	-	390115-L	19084175	-	6000	9	600115-L	19083920	-	600115-L	19083984	-

- L: With LED lighting

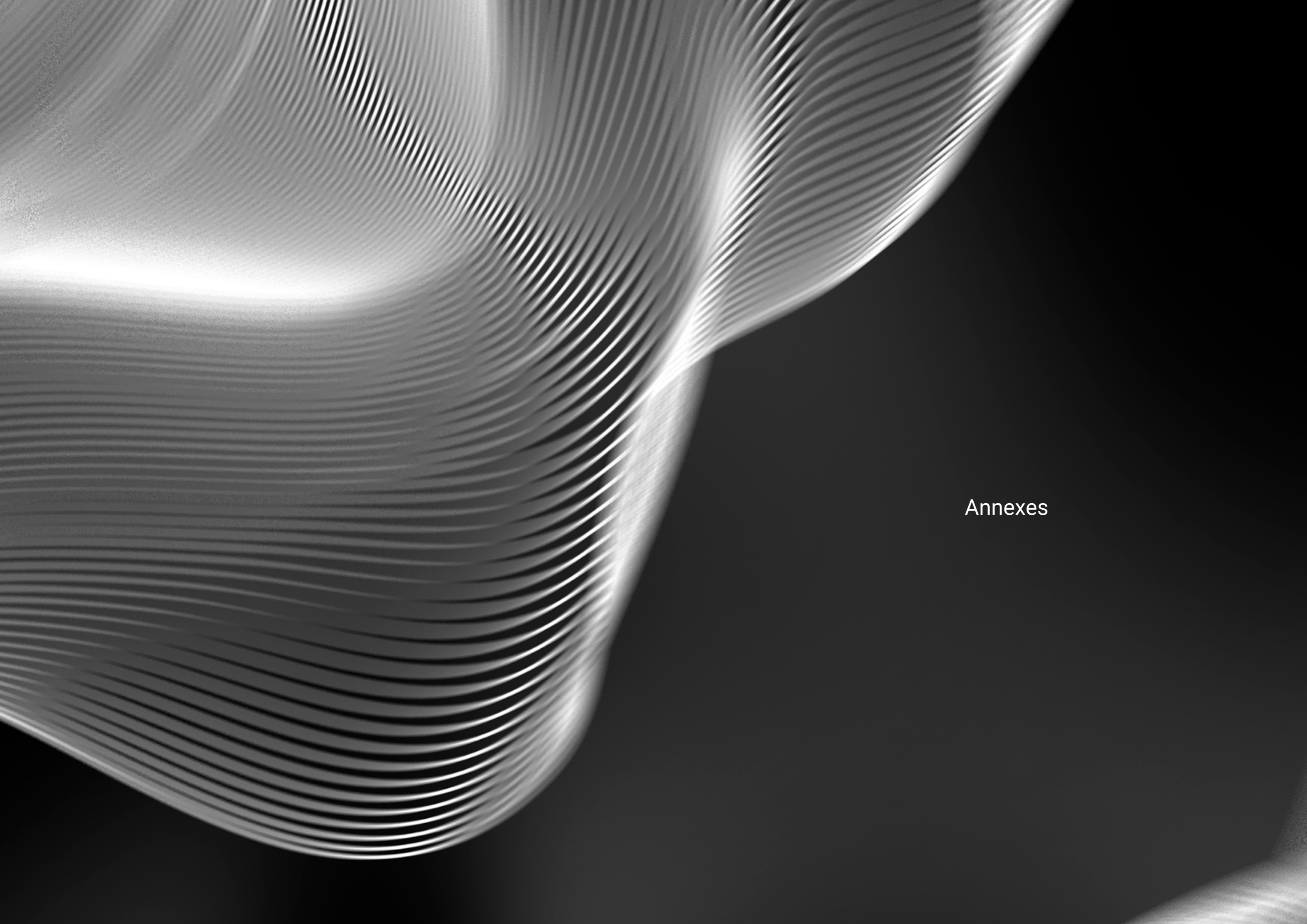

Annexes



# Terms and conditions of sale

01.

## Prices

All prices included in our invoices are in euro, net ex works. Prices exclude delivery, unloading, positioning or installation.

02.

## Transport

Goods are freighted under buyer's responsibility.

Delivery is free on truck: unloading not included.

Complains: goods are freighted under insurance coverage. It is clients' task to check goods for damages upon delivery.

Complains not related to transportation must be sent within 5 days from goods reception.

Besides above mentioned cases, goods received with signature on shipping bulletin are accepted henceforth.

03.

## Packing

Standard packing is included in the present prices. Other packing will be quoted separately.

04.

## Guarantee

We warranty all our products against manufacturer fault during ONE YEAR from manufacturer or expedition date.

The faulty parts will be replaced with an ex-works delivery.

We shall not obliged to replace any goods or make any allowance or other arrangement if the defect has arisen from accident, misuse, neglect, incorrect installation, or any other cause beyond our control.

Where the defect is reasonably attributable to the fault of the manufacturer, the Manufacturer shall replace or repair the defective goods but shall not be liable for any cost of removal of the defective goods, or of the installation of replacement or any consequential loss or damage arisen there from.

The manufacturer's liability shall be limited to the repair or replacement of materials and components manufactured by us.

Where goods and components supplied by us are not of our's design and manufacture, the liability shall be limited to the guarantee provided by the manufacture of such goods and components.

05.

## Publications

Right of new developments and technical modifications reserved.

Prices and article numbers subject to change without notice.

This price list supersedes all earlier list.

Specifications :

Some previous considerations have to be mention here than before were not indicated because we had consider as obviously clear for every one.

The technical descriptions of our machines trying to give a description of the main characteristics, nevertheless the revisions of the industrial process could produce modifications of any of these values.

Fagor Industrial have the right to introduce the modifications that could consider necessary if they not modify the main characteristics and requirements of the machine .

06.

## Delay

Time for performance by the Manufacturer is given in good faith, as accurately as possible, but is not to be the essence of the contract. The Customer shall have not right to damages or to impose penalties in the event of late delivery by the Manufacturer or his clients, or to cancel the order or the contract for delay from any causes unless agreed in writing by the Manufacturer.

Delivery terms are merely indicative and subject to FAGOR production times. Delays do not entitle to any refund or liability whatsoever.

07.

## Cancellation and restocking

The Manufacturer at its absolute discretion may agree to the return of goods by the customer provided that the goods are returned at the customer expense, in the same condition and in the original packing.

Any goods agreed by the Manufacturer as acceptable for return for any reason, excluding faulty goods, will be subject to a restocking charge of 35 % of the net invoice value.

7-1. Orders can not be cancelled if the have been confirmed and accepted in writing , specially tailor made equipment.

We'll consider any order confirmed if we don't receive any negative reaction in 24 hours from our confirmation date.

7-2. Fagor Industrial will only accepted any cancellation as follow :

- If the dealer's cancel is before goods have left our warehouse a 50.00 € charge, net, per item will be made to cover our administration and logistics cost.

- If the dealer's cancel is after goods have left our warehouse, a charge of 20 % of invoice value will be charge plus an abortive delivery charge if it is necessary .

- If the goods had been unpacked, a minimum of 25 % of invoice value will be charge only for this concept.

08.

## Payments

The payments will be made on time, even if the transport, the setting in service or the reception of the installation are delayed or canceled by reasons that are not attributable to us.

09.

## Arbitration

The Parties should try to settle any disputes and differences which can arise by negotiations. If the parties will not come to agreement, the arisen dispute will be submitted for consideration to a neutral Court as it is The International Commercial Arbitration court of Paris, the arbitrator would also know and speak English and Spanish.



