

# DRYING

## SINGLE POCKET DRYERS ADVANCE+ SR-11/14 TP2 PLUS

### CHARACTERISTICS

#### TP2

- User friendly and totally programmable 7" TP2.
- USB Connection.
- Online platform for programming, telemetry, data analysis...thanks to the IoT.
- Videos on display: ads, instructions, etc.
- 37 languages.

#### OUTSTANDING FEATURES

- Reversing drum action as standard.
- Stainless steel drum as standard.
- Frequency inverter as standard.

#### EFFICIENCY

- Intelligent humidity control with drum inlet temperature control.
- Efficient air recirculation system.
- Double door glass.
- Optimized system of mixed airflow.
- Big fluff filter.

#### VERSATILITY

- Make to order - customisation.
- Wet Cleaning.

#### CONNECTIVITY

- Standard IoT FagorKconnect.
- Management of laundries: OPL and COIN.

#### ERGONOMICS

- Drawer as fluff filter, made of stainless steel.
- Biggest door diameters.
- Opening sense of door adjustable on site.

#### MAINTENANCE

- Hinged panel: easy and ergonomic access.
- Technical menu: statistics for technicians.

#### OTHERS

- Grey skinplate outer casing, stainless steel look.
- Integrated Fire Extinguishing System.
- Drum with stamped holes.
- Anti-wrinkle at the end of the cycle.
- Heating options: electric, gas and steam.
- CE approved.

#### OPTIONS

- Opposite door opening.
- Tropicalized model.
- Dosing/spraying system.
- Back panel external air + filter.
- Fluff filter with grid 0,6mm (standard is 0,3mm).
- Fluff filter with grid 1,2mm (standard is 0,3mm).
- Stainless steel front and side panels
- Front panel in stainless steel
- Steam battery in stainless steel.
- Low pressure steam battery.
- Reduced power (12kw instead of 18kw) for SR-14.
- Other voltages available.
- Maritime wooden packing.



	U.	SR-11 TP2 PLUS	SR-14 TP2 PLUS
<b>CAPACITY</b>			
Capacity 1/18	Kg	11,7	15
	Lb	25,7	33,1
Capacity 1/20	Kg	10,5	13,5
	Lb	23,1	29,8
<b>DRUM</b>			
Ø Drum	mm	750	750
	inch	29,53	29,53
Drum length	mm	475	610
	inch	18,7	24,02
Drum volume	l	210	270
	cu ft	7,41	9,53
Ø Door	mm	574	574
	inch	22,6	22,6
Floor to door center	mm	976	976
	inch	38,43	38,43
Floor to lower part of the door	mm	618	618
	inch	24,33	24,33
Drum motor power	kW	0,37	0,37
<b>ELECTRIC POWER</b>			
Installed heating power	kW	12	18
Installed electrical power	kW	12,97	18,97
Evaporation capacity	l/h	11	14,5
	USgallon/h	2,91	3,8
Hourly output	Kg/h	21,7	29
	Lb/h	47,8	63,9
<b>GAS POWER</b>			
Installed heating power gas	Kcal/h	17638	17638
	Btu/h	70000	70000
Installed heating power gas	kW	20,51	20,51
Installed electrical power	kW	0,97	0,97
Instant propane gas consumption (G31)	Kg/h	1,76	1,76
	Lb/h	3,88	3,88
Instant natural gas consumption (G20)	m³/h	2,17	2,17
	cfm	1,28	1,28
Evaporation capacity	l/h	15	15,6
	USgallon/h	3,95	4,12
Hourly output	Kg/h	31,3	32,5
	Lb/h	68,9	71,6
Ø Gas inlet	BSPP ISO 228-1	1/2"	1/2"
<b>STEAM POWER</b>			
Installed heating power steam	kW	30	30
	Btu/h	102364	102364
Installed electrical power	kW	0,97	0,97
Steam consumption (8 barG) - Stándar	Kg/h	53	53
Steam consumption (116 psiG)	Lb/h	63,8	63,8
Steam pressure - Standard	barG	6 - 9	6 - 9
	psiG	87 - 130.5	87 - 130.5
Steam inlet - steam outlet - Standard	BSPT- ISO7.1	3/4"	3/4"
Steam inlet - condensate outlet	NPT ANSI B1.20.1 Tapered	3/4"	3/4"
Steam consumption (5 bagG) - Low pressure	Kg/h	57	57
Steam consumption (72,5 psiG) - Low pressure	Lb/h	68,7	68,7
Steam pressure - Low Pressure	barG	3 - 6	3 - 6
	psiG	43.5 - 88	43.5 - 90
Steam Inlet - Steam Outlet - Low Pressure	BSPT - ISO7.1	1"	1"

VENTILATION					
Nominal air flow	m³/h	1.200	1.200		
	cfm	706,29	706,29		
Air outlet Ø	mm	200	200		
	inch	7,87	7,87		
Fan motor power	kW	0,55	0,55		
HEAT DISSIPATION					
Total max heat dissipation	kW	0,96	1,44		
	kW	3277,6	4916,4		
Front pannel max heat dissipation	Btu/h	0,6	0,9		
	Btu/h	2048,5	3072,7		
CONNECTIONS		ELECTRICAL	STEAM / GAS	ELECTRICAL	STEAM / GAS
Tension 230V - I + N + T	Nº x mm2 / A	3 x 25 / 63 A	3x1.5 / 16 A	-	3x1.5 / 16 A
Tension 230V - III + T	Nº x mm2 / A	4 x 10 / 40 A	3x1.5 / 16 A	4 x 16 / 63 A	3x1.5 / 20 A
Tension 400V - III + N + T	Nº x mm2 / A	5 x 4 / 25 A	3x1.5 / 16 A	5 x 10 / 32 A	3x1.5 / 20 A
DIMENSIONS / PACKING DIMENSIONS					
Net width / Gross width	mm	785 / 865	785 / 865		
	inch	30,91 / 34,06	30,91 / 34,06		
Net depth / Gross depth	mm	855 / 940	989 / 1.074		
	inch	33,66 / 37,01	38,94 / 42,28		
Net height / Gross height	mm	1.694 / 1.840	1.694 / 1.840		
	inch	66,69 / 72,44	66,69 / 72,44		
Net weight / Gross weight	Kg	172 / 180	180 / 190		
	Lb	379,26 / 396,83	396,83 / 418,88		
OTHERS					
Sound level	dB	64	65		

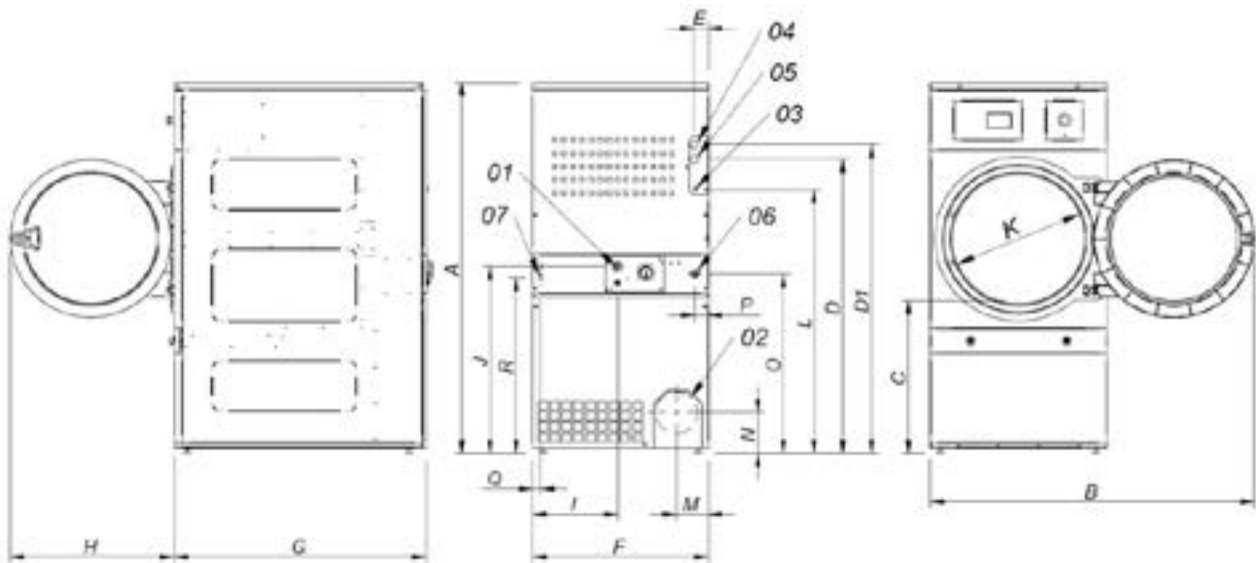

- 01. Power supply
- 02. Fumes output Ø200
- 03. Gas inlet 1/2"
- 04. Steam inlet 3/4"
- 05. Condensate outlet 3/4"
- 06. Sprinkler valve 3/4"
- 07. Ethernet connection

	A	B	C	D	D1	E	E1	F	G	H	I	J	K	L	M	N	O	P	Q	R
SR-11 TP2 PLUS	1694	1447	689	1354	1422	68	68	785	855	735	380	870	575	1226	133	180	830	65	35	805
SR-14 TP2 PLUS	1694	1447	689	1354	1422	68	68	785	989	735	380	870	575	1226	133	180	880	65	35	805

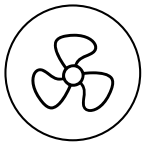

# DRYING

## SINGLE POCKET DRYERS ADVANCE+ SR-18/22 TP2 PLUS

### CHARACTERISTICS

#### TP2

- User friendly and totally programmable 7" TP2.
- USB Connection.
- Online platform for programming, telemetry, data analysis...thanks to the IoT.
- Videos on display: ads, instructions, etc.
- 37 languages.

#### OUTSTANDING FEATURES

- Reversing drum action as standard.
- Stainless steel drum as standard.
- Frequency inverter as standard.

#### EFFICIENCY

- Intelligent humidity control with drum inlet temperature control.
- Efficient air recirculation system.
- Double door glass.
- Optimized system of mixed airflow.
- Big fluff filter.

#### VERSATILITY

- Make to order - customisation.
- Wet Cleaning.

#### CONNECTIVITY

- Standard IoT FagorKonnnect.
- Management of laundries: OPL and COIN.

#### ERGONOMICS

- Drawer as fluff filter, made of stainless steel.
- Biggest door diameters.
- Opening sense of door adjustable on site.

#### MAINTENANCE

- Hinged panel: easy and ergonomic access.
- Technical menu: statistics for technicians.

#### OTHERS

- Grey skinplate outer casing, stainless steel look.
- Integrated Fire Extinguishing System.
- Drum with stamped holes.
- Anti-wrinkle at the end of the cycle.
- Heating options: electric, gas and steam.
- CE approved.

#### OPTIONS

- Opposite door opening.
- Tropicalized model.
- Dosing/spraying system.
- Back panel external air + filter.
- Fluff filter with grid 0,6mm (standard is 0,3mm).
- Fluff filter with grid 1,2mm (standard is 0,3mm).
- Stainless steel front and side panels
- Front panel in stainless steel
- Steam battery in stainless steel.
- Low pressure steam battery.
- Reduced power (12kw instead of 18kw) for SR-18.
- Other voltages available.
- Maritime wooden packing.



	U.	SR-18 TP2 PLUS	SR-22 TP2 PLUS
<b>CAPACITY</b>			
Capacity 1/18	Kg	18,3	24,3
	Lb	40,4	53,9
Capacity 1/20	Kg	16,5	22
	Lb	36,3	48,5
<b>DRUM</b>			
Ø Drum	mm	750	835
	inch	29,53	32,87
Drum length	mm	746	800
	inch	29,37	31,5
Drum volume	l	330	440
	cu ft	11,64	15,54
Ø Door	mm	574	574
	inch	22,6	22,6
Floor to door center	mm	976	1.030
	inch	38,43	40,55
Floor to lower part of the door	mm	618	672
	inch	24,33	26,46
Drum motor power	kW	0,37	0,37
<b>ELECTRIC POWER</b>			
Installed heating power	kW	18	24
Installed electrical power	kW	18,97	25,17
Evaporation capacity	l/h	14,9	20
	USgallon/h	3,94	5,3
Hourly output	Kg/h	30	40
	Lb/h	66,1	88,2
<b>GAS POWER</b>			
Installed heating power gas	Kcal/h	17638	26655
	Btu/h	70000	105775,6
Installed heating power gas	kW	20,51	31
Installed electrical power	kW	0,97	1,17
Instant propane gas consumption (G31)	Kg/h	1,76	2,66
	Lb/h	3,88	5,86
Instant natural gas consumption (G20)	m³/h	2,17	3,28
	cfm	1,28	1,93
Evaporation capacity	l/h	16,3	22,3
	USgallon/h	4,306	5,89
Hourly output	Kg/h	33,6	44,6
	Lb/h	74,1	98,3
Ø Gas inlet	BSPP ISO 228-1	1/2"	1/2"
<b>STEAM POWER</b>			
Installed heating power steam	kW	30	49,2
	Btu/h	102364	167877
Installed electrical power	kW	0,97	1,17
Steam consumption (8 barG) - Stándar	Kg/h	53	87
Steam consumption (116 psiG)	Lb/h	63,8	104,8
Steam pressure - Standard	barG	6 - 9	6 - 9
	psiG	87 - 130.5	87 - 130.5
Steam inlet - steam outlet - Standard	BSPT- ISO7.1	3/4"	1"
Steam inlet - condensate outlet	NPT ANSI B1.20.1 Tapered	3/4"	1"
Steam consumption (5 bagG) - Low pressure	Kg/h	57	-
Steam consumption (72,5 psiG) - Low pressure	Lb/h	68,7	-
Steam pressure - Low Pressure	barG	3 - 6	3 - 6
	psiG	43.5 - 92	43.5 - 94
Steam Inlet - Steam Outlet - Low Pressure	BSPT - ISO7.1	1"	1"

VENTILATION					
Nominal air flow	m³/h	1.200	1.500		
	cfm	706,29	882,87		
Air outlet Ø	mm	200	200		
	inch	7,87	7,87		
Fan motor power	kW	0,55	0,75		
HEAT DISSIPATION					
Total max heat dissipation	kW	1,44	1,92		
	kW	4.916,4	6.555,1		
Front pannel max heat dissipation	Btu/h	0,9	1,2		
	Btu/h	3.072,7	4.097		
CONNECTIONS		ELECTRICAL	STEAM / GAS	ELECTRICAL	STEAM / GAS
Tension 230V - I + N + T	Nº x mm2 / A	-	3x1.5 / 16 A	-	3x1.5 / 16 A
Tension 230V - III + T	Nº x mm2 / A	4 x 16 / 63A	3x1.5 / 16 A	4 x 25 / 80 A	3x1.5 / 16 A
Tension 400V - III + N + T	Nº x mm2 / A	5x10 / 32A	3x1.5 / 16 A	5 x 10 / 40 A	3x1.5 / 16 A
DIMENSIONS / PACKING DIMENSIONS					
Net width / Gross width	mm	785 / 865	890 / 970		
	inch	30,91 / 34,06	35,04 / 38,19		
Net depth / Gross depth	mm	1.125 / 1.210	1.255 / 1.345		
	inch	44,29 / 47,64	49,41 / 52,95		
Net height / Gross height	mm	1.694 / 1.840	1.812 / 1.940		
	inch	66,69 / 72,44	71,34 / 76,38		
Net weight / Gross weight	Kg	187 / 200	210 / 230		
	Lb	412,26 / 440,92	462,97 / 507,06		
OTHERS					
Sound level	dB	64	65		

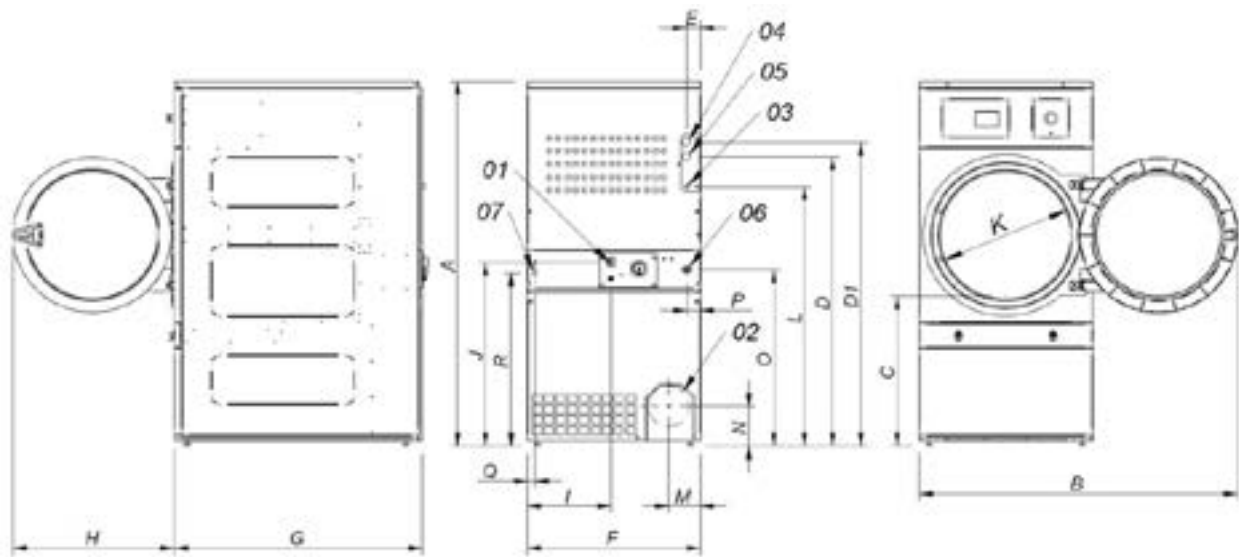

- 01. Power supply
- 02. Fumes output Ø200
- 03. Gas inlet 1/2"
- 04. Steam inlet 3/4" (1" SR-22)
- 05. Condensate outlet 3/4" (1" SR-22)
- 06. Sprinkler valve 3/4"
- 07. Ethernet connection

	A	B	C	D	D1	E	E1	F	G	H	I	J	K	L	M	N	O	P	Q	R
SR-18 TP2 PLUS	1694	1447	689	1354	1422	68	68	785	1125	735	380	870	575	1226	133	180	830	65	35	805
SR-22 TP2 PLUS	1812	1552	743	1430	1532	112	55	890	1255	735	107	920	575	1344	238	180	885	65	37	860

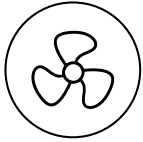

# DRYING

## SINGLE POCKET DRYERS ADVANCE+ SR-28/35 TP2 PLUS

### CHARACTERISTICS

#### TP2

- User friendly and totally programmable 7" TP2.
- USB Connection.
- Online platform free of charge for programming, telemetry, data analysis... thanks to the IoT.
- Videos on display (ads, instructions, etc).
- 37 languages.

#### OUTSTANDING FEATURES

- Reversing drum action as standard.
- Stainless steel drum as standard.
- Frequency inverter as standard.

#### EFFICIENCY

- Intelligent humidity control with drum inlet temperature control.
- Efficient air recirculation system.
- Complete air-flow circuit.
- Double door glass.
- Optimized system of mixed airflow.
- Big fluff filter.

#### VERSATILITY

- Make to order - customisation.
- Wet Cleaning.

#### CONNECTIVITY

- Standard IoT FagorKonnnect.
- Management of laundries: OPL and COIN.

#### ERGONOMICS

- Drawer as fluff filter, made of stainless steel.
- Biggest door diameters.
- Opening sense of door adjustable on site.

#### MAINTENANCE

- Hinged panel: easy and ergonomic access
- Technical menu: statistics for technicians.

#### OTHERS

- Grey skinplate outer casing, stainless steel look.
- Integrated Fire Extinguishing System.
- Drum with stamped holes.
- Anti-wrinkle at the end of the cycle.
- Heating options: electric, gas and steam.
- CE approved.

#### OPTIONS

- Opposite door opening.
- Tropicalized model.
- Dosing/spraying system.
- Back panel external air + filter.
- Fluff filter with grid 0,6mm (st andard is 0,3mm).
- Fluff filter with grid 1,2mm (st andard is 0,3mm).
- Stainless steel front and side panels.
- Front panel in stainless steel.
- Steam battery in stainless steel.
- Low pressure steam battery.
- Other voltages available.
- Maritime wooden packing.



	U.	SR-28 TP2 PLUS	SR-35 TP2 PLUS
<b>CAPACITY</b>			
Capacity 1/18	Kg	30,6	36,7
	Lb	67,3	80,8
Capacity 1/20	Kg	27,5	33
	Lb	60,6	72,8
<b>DRUM</b>			
Ø Drum	mm	947	947
	inch	37,28	37,28
Drum length	mm	780	936
	inch	30,71	36,85
Drum volume	l	550	660
	cu ft	19,42	23,3
Ø Door	mm	802	802
	inch	31,57	31,57
Floor to door center	mm	1.040	1.040
	inch	40,94	40,94
Floor to lower part of the door	mm	578	578
	inch	22,74	22,74
Drum motor power	kW	0,55	0,55
<b>ELECTRIC POWER</b>			
Installed heating power	kW	30	36
Installed electrical power	kW	31,35	37,35
Evaporation capacity	l/h	26,8	31,5
	USgallon/h	7,1	8,3
Hourly output	Kg/h	51,6	63,9
	Lb/h	113,8	140,9
<b>GAS POWER</b>			
Installed heating power gas	Kcal/h	35276	35276
	Btu/h	139986,5	139986,5
Installed heating power gas	kW	41	41
Installed electrical power	kW	1,35	1,35
Instant propane gas consumption (G31)	Kg/h	3,51	3,51
	Lb/h	7,74	7,74
Instant natural gas consumption (G20)	m³/h	4,34	4,34
	cfm	2,55	2,55
Evaporation capacity	l/h	31,8	34,7
	USgallon/h	8,401	9,167
Hourly output	Kg/h	61,1	73,3
	Lb/h	134,7	161,6
Ø Gas inlet	BSPP ISO 228-1	1/2"	1/2"
<b>STEAM POWER</b>			
Installed heating power steam	kW	50,1	50,1
	Btu/h	170948	170948
Installed electrical power	kW	1,35	1,35
Steam consumption (8 barG) - Stándar	Kg/h	89	89
Steam consumption (116 psiG)	Lb/h	107,2	107,2
Steam pressure - Standard	barG	6 - 9	6 - 9
	psiG	87 - 130.5	87 - 130.5
Steam inlet - steam outlet - Standard	BSPT- ISO7.1	1"	1"
Steam inlet - condensate outlet	NPT ANSI B1.20.1 Tapered	1"	1"
Steam consumption (5 bagG) - Low pressure	Kg/h	93	93
Steam consumption (72,5 psiG) - Low pressure	Lb/h	112	112
Steam pressure - Low Pressure	barG	3 - 6	3 - 6
	psiG	43.5 - 96	43.5 - 98
Steam Inlet - Steam Outlet - Low Pressure	BSPT - ISO7.1	1 1/2"	1 1/2"



VENTILATION					
Nominal air flow	m <sup>3</sup> /h	1.500	1.500		
	cfm	882,87	882,87		
Air outlet Ø	mm	200	200		
	inch	7,87	7,87		
Fan motor power	kW	0,75	0,75		
HEAT DISSIPATION					
Total max heat dissipation	kW	2,4	2,88		
	kW	8.193,9	9832,7		
Front pannel max heat dissipation	Btu/h	1,5	1,8		
	Btu/h	5.121,2	6145,5		
CONNECTIONS					
		ELECTRICAL	STEAM / GAS	ELECTRICAL	STEAM / GAS
Tension 230V - I + N + T	N° x mm2 / A	-	3x1.5 / 16 A	-	3x1.5 / 16 A
Tension 230V - III + T	N° x mm2 / A	4 x 35 / 100 A	3x1.5 / 16 A	4 x 50 / 125 A	3x1.5 / 16 A
Tension 400V - III + N + T	N° x mm2 / A	5 x 16 / 63 A	3x1.5 / 16 A	5 x 16 / 63 A	3x1.5 / 16 A
DIMENSIONS / PACKING DIMENSIONS					
Net width / Gross width	mm	985 / 1.065	985 / 1065		
	inch	38,78 / 41,93	38,78 / 41,93		
Net depth / Gross depth	mm	1.054 / 1.154	1.210 / 1.310		
	inch	41,5 / 45,43	47,64 / 51,57		
Net height / Gross height	mm	1.975 / 2.080	1.975 / 2.080		
	inch	77,76 / 81,89	77,76 / 81,89		
Net weight / Gross weight	Kg	230 / 260	260 / 285		
	Lb	507,06 / 573,2	573,20 / 628,32		
OTHERS					
Sound level	dB	65	65		

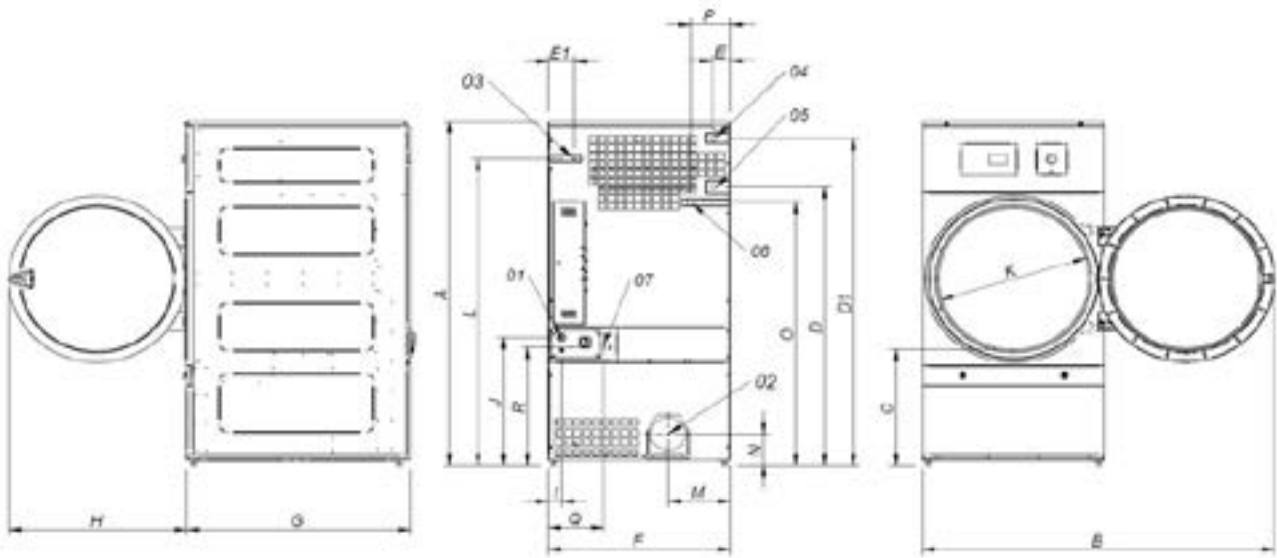

- 01. Power supply
- 02. Fumes output Ø200
- 03. Gas inlet 1/2"
- 04. Steam inlet 1"
- 05. Condensate outlet 1"
- 06. Sprinkler valve 3/4"
- 07. Ethernet connection

	A	B	C	D	D1	E	E1	F	G	H	I	J	K	L	M	N	O	P	Q	R
SR-28 TP2 PLUS	1975	1910	660	1590	1875	102	130	985	1054	970	70	730	802	1760	337	178	1510	215	301	676
SR-35 TP2 PLUS	1975	1910	660	1590	1875	102	130	985	1210	970	70	730	802	1760	337	178	1510	215	301	676

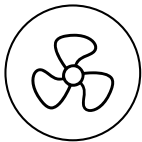

# DRYING

## SINGLE POCKET DRYERS ADVANCE+ SR-45/60/80 TP2 PLUS



### CHARACTERISTICS

#### TP2

- User friendly and totally programmable 7" TP2.
- USB Connection.
- Online platform free of charge for programming, telemetry, data analysis... thanks to the IoT.
- Videos on display (ads, instructions, etc).
- 37 languages.

#### OUTSTANDING FEATURES

- Reversing drum action as standard.
- Stainless steel drum as standard.
- Frequency inverter as standard.
- 

#### EFFICIENCY

- Intelligent humidity control with drum inlet temperature control.
- Efficient air recirculation system.
- Complete air-flow circuit.
- Double door glass.
- Optimized system of mixed airflow.
- Big fluff filter.

#### VERSATILITY

- Make to order - customisation.
- Wet Cleaning.

#### CONNECTIVITY

- Standard IoT FagorKonnnect.
- Management of laundries: OPL and COIN.
- 

#### ERGONOMICS

- Drawer as fluff filter, made of stainless steel.
- Biggest door diameters.
- Opening sense of door adjustable on site.

#### MAINTENANCE

- Hinged panel: easy and ergonomic access.
- Technical menu: statistics for technicians.

#### OTHERS

- Grey skinplate outer casing, stainless steel look.
- **New:** transmission by geared motor on models SR-45/60/80.
- Integrated Fire Extinguishing System.
- Drum with stamped holes.
- Anti-wrinkle at the end of the cycle.
- Heating options: electric, gas and steam.
- CE approved.

#### OPTIONS

- Automatic (double glass) or manual sliding door.
- Tilting front kit.
- Opposite door opening.
- Tropicalized model.
- Dosing/spraying system.
- Back panel external air + filter.
- Fluff filter with grid 0,6mm (st andard is 0,3mm).
- Fluff filter with grid 1,2mm (st andard is 0,3mm).
- Stainless steel front and side panels.
- Front panel in stainless steel.
- Low pressure steam battery.
- Other voltages available.
- Maritime wooden packing.

	U.	SR-45 TP2 PLUS	SR-60 TP2 PLUS	SR-80 TP2 PLUS
<b>CAPACITY</b>				
Capacity 1/18	Kg	50	66,7	83,3
	Lb	110,2	146,9	183,6
Capacity 1/20	Kg	45	60	75
	Lb	99,2	132,3	165,3
<b>DRUM</b>				
Ø Drum	mm	1.225	1.225	1.225
	inch	48,23	48,23	48,23
Drum length	mm	760	1.020	1.252
	inch	29,92	40,16	49,29
Drum volume	l	900	1.200	1.500
	cu ft	31,78	42,37	52,95
Ø Door	mm	802	802	802
	inch	31,57	31,57	31,57
Floor to door center	mm	1.275	1.275	1.275
	inch	50,2	50,2	50,2
Floor to lower part of the door	mm	813	813	813
	inch	31,99	31,99	31,99
Drum motor power	kW	0,75	1,1	1,5
<b>ELECTRIC POWER</b>				
Installed heating power	kW	54	72	72
Installed electrical power	kW	57	75,35	75,75
Evaporation capacity	l/h	45	64	68,2
	USgallon/h	11,9	16,91	18,02
Hourly output	Kg/h	90	128,6	136,4
	Lb/h	198,4	283,5	300,7
<b>GAS POWER</b>				
Installed heating power gas	Kcal/h	51591	77386	103181
	Btu/h	204728,5	307092,7	409456,9
Installed heating power gas	kW	60	90	120
Installed electrical power	kW	3	3,35	3,75
Instant propane gas consumption (G31)	Kg/h	5,14	7,71	10,28
	Lb/h	11,33	17	22,66
Instant natural gas consumption (G20)	m³/h	6,35	9,53	12,71
	cfm	3,74	5,61	7,48
Evaporation capacity	l/h	48,2	72	93,8
	USgallon/h	12,73	19,02	24,78
Hourly output	Kg/h	96,4	144	187,5
	Lb/h	212,5	317,5	413,4
Ø Gas inlet	BSPP ISO 228-1	3/4"	3/4"	3/4"
<b>STEAM POWER</b>				
Installed heating power steam	kW	91	128	128
	Btu/h	310505	436754	436754
Installed electrical power	kW	3	3,35	3,75
Steam consumption (8 barG) - Stándar	Kg/h	121	171	171
Steam consumption (116 psiG)	Lb/h	145,8	206	206
Steam pressure - Standard	barG	7 - 12	7 - 12	7 - 12
	psiG	101.5 - 175	101.5 - 177	101.5 - 179
Steam inlet - steam outlet - Standard	BSPT- ISO7.1	1"	1"	1"
Steam inlet - condensate outlet	NPT ANSI B1.20.1 Tapered	1"	1"	1"
Steam consumption (5 bagG) - Low pressure	Kg/h	142	147	147
Steam consumption (72,5 psiG) - Low pressure	Lb/h	171,1	177,1	177,1
Steam pressure - Low Pressure	barG	4 - 7	4 - 7	4 - 7
	psiG	58 - 101.5	58 - 101.5	58 - 101.5
Steam Inlet - Steam Outlet - Low Pressure	BSPT - ISO7.1	1" 1/2	1" 1/2	1" 1/2

THERMAL OIL							
Installed heating power	kW	91	128	128			
Installed electrical power	kW	3	3,35	3,75			
Fluid consumption (T max175°C)	m³/h	7	10	10			
Connections thermal oil	BSP	1" 1/2	1" 1/2	1" 1/2			
VENTILATION							
Nominal air flow	m³/h	4.500	4.500	4.500			
	cfm	2648,6	2648,6	2648,6			
Air outlet Ø	mm	300	300	300			
	inch	11,81	11,81	11,81			
Fan motor power	kW	2,2	2,2	2,2			
HEAT DISSIPATION							
Total max heat dissipation	kW	3,78	5,04	5,04			
	Btu/h	12905,4	17207,3	17207,3			
Front pannel max heat dissipation	kW	1,08	1,44	1,44			
	Btu/h	3687,3	4916,4	4916,4			
CONNECTIONS							
		ELECTRICAL	STEAM / GAS	ELECTRICAL	STEAM / GAS	ELECTRICAL	STEAM / GAS
Tension 230V - I + N + T	Nº x mm2 / A	-	-	-	-	-	-
Tension 230V - III + T	Nº x mm2 / A	-	4x2.5 / 20 A	-	4x2.5 / 25 A	-	4x2.5 / 25 A
Tension 400V - III + N + T	Nº x mm2 / A	5 x 35 / 100 A	5x2.5 / 20 A	5 x 50 / 125 A	4x2.5 / 25 A	5 x 50 / 125 A	5x2.5 / 25 A
DIMENSIONS / PACKING DIMENSIONS							
Net width / Gross width	mm	1.270 / 1.330		1.270 / 1.330		1.270 / 1.330	
	inch	50 / 52,36		50 / 52,36		50 / 52,36	
Net depth / Gross depth	mm	1.106 / 1.185		1.366 / 1.455		1.598 / 1.705	
	inch	43,54 / 46.65		53,78 / 57,28		62,91 / 67,13	
Net height / Gross height	mm	2.380 / 2.200		2.380 / 2.200		2.380 / 2.200	
	inch	93,70 / 86,61		93,7 / 86,61		93,7 / 86,61	
Net weight / Gross weight	Kg	395 / 430		529 / 575		657 / 715	
	Lb	870,83 / 947,99		1.166,25 / 1.267,66		1.448,44 / 1.576,31	
OTHERS							
Sound level	dB	67		67		67	

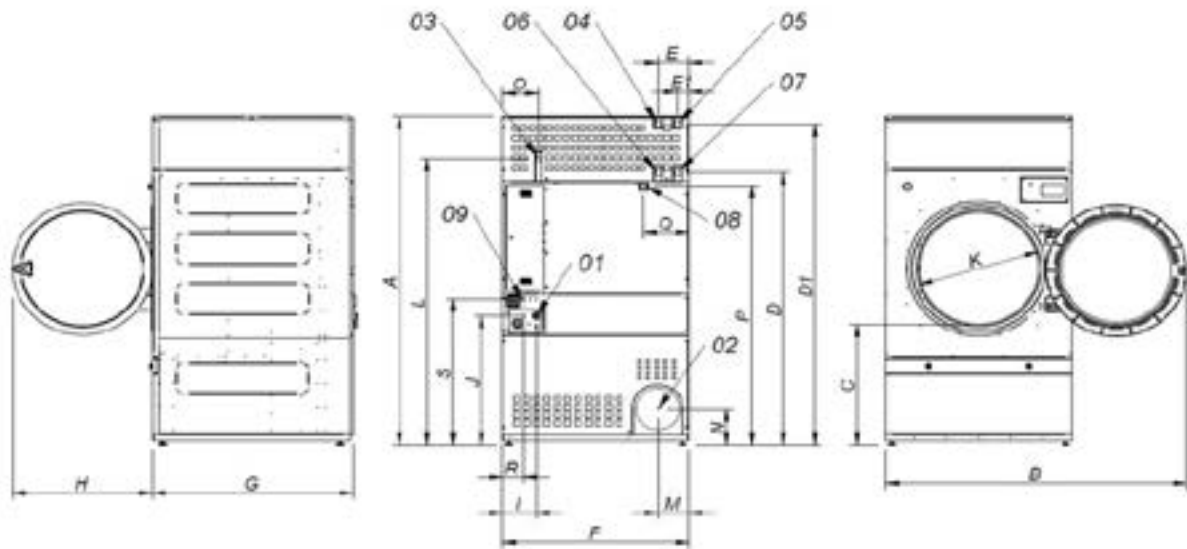

- 01. Power supply
- 02. Fumes output Ø300
- 03. Gas inlet 3/4"
- 04. Steam inlet 1" (SR-45)
- 05. Steam inlet 1" (SR-60/80)
- 06. Condensate outlet 1" (SR-45)
- 07. Condensate outlet 1" (SR-60/80)
- 08. Sprinkler valve 3/4"
- 09. Ethernet connection

	A	B	C	D	D1	E	E1	F	G	H	I	J	K	L	M	N	O	P	Q	R	S
SR-45 TP2 PLUS	2380	2045	874	1981	2311	211	80	1270	1106	956	248	935	802	2088	214	240	244	1841	308	160	1053
SR-60 TP2 PLUS	2380	2045	874	1981	2311	211	80	1270	1366	956	248	935	802	2088	214	240	244	1841	308	160	1053
SR-80 TP2 PLUS	2380	2045	874	1981	2311	211	80	1270	1598	956	248	935	802	2088	214	240	244	1841	308	160	1053