



Warewashing



Get to know how FagorKonnnect potentiates the functionality of the devices, specifically the dishwashing.



Specific graphs designed for dishwashing analysis:

To perform dishwashing equipment analysis focusing on specific aspects such as device status, error analysis, and cycles run per programme and per day, you could use intuitive and specific graphics that highlight the information.



Detailed information displayed in real time:

Key data will be displayed to monitor dishwashing equipment and perform actions such as setting parameters, switching the equipment on or off or network configuration.

View and download the HACCP of a particular device:

HACCP for a specific device is available. Obtains a graph over a range of selected dates.

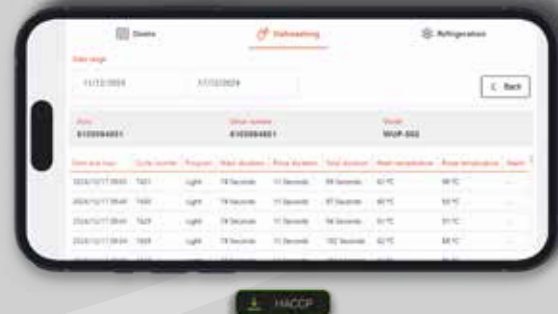

Next generation Dishwashing.

iNOVA
GENERATION

*Innovative washing
technology for unique
results.*



Warewashing

Small and medium productions.....	177
Utensil washers.....	209
Rack conveyors.....	213
Flight type dishwashers.....	231
Baskets.....	243

WATER CONNECTION SPECIFICATIONS:

pH: 6,5 ÷ 7,5

Total water hardness: 5 ÷ 10 °fH

3,5 ÷ 7 °eH

2,8 ÷ 5,6 °dH

Impurities: Ø < 0,08 mm

Chlorides: ≤ 100 mg/l

Chlorine: 0 ÷ 0,5 mg/l

Conductivity: 400 ÷ 2.000 µS/cm

Operating problems resulting from a faulty installation that does not comply with the above premises will not be considered under warranty.

 **STOCK** This applies to 50 Hz models.



The small and versatile solution for brilliant results.

Small and medium productions

Introduction	179
Glasswashers	183
— Concept +	183
— Concept	185
Front loading dishwashers	187
— Advance	187
— Concept +	189
— Concept	191
Hood type dishwashers	195
— Advance	195
— Concept +	197
— Concept	199
Sanitary dishwashers	201
— Front loading dishwashers	201
— Hood type dishwashers	203
Accessories	205
— Accessories	205
— Water treatment	207

iNOVA

GENERATION

ADVANCE | A

Technology and efficiency





CONCEPT+ | P

Flexibility

CONCEPT | C

Simplicity



		CONCEPT C	CONCEPT+ P			ADVANCE A
		MAINS PRESSURE (2-4 BAR)	MAINS PRESSURE (2-4 BAR)	RINSE PUMP (1-4 BAR)		RINSE PUMP (1-4 BAR)
Glasswashers (G)	 400X400	WGC-400 (1)	WGP-400 (1)	WGP-401 (1)		
Front loading dishwashers (U)	 500X500	WUC-502 WUC-500 (1)	WUP-502	WUP-503	WUP-503 SN 	WUA-503
Hood type dishwashers (H)	 500X500	WHC-502	WHP-502	WHP-503	WHP-503 SN 	WHA-503

(1) Single-phase version.

Interface

ADVANCE | A

CONCEPT+ | P

FagorKonnect



White
Machine not ready



Green
Machine ready



Blue
In progress

- 2.8" backlit colour (TFT) liquid crystal display.
- Colour-coded status indicators.
- Display of operating parameters, such as wash and rinse temperatures or cycle times.
- Indicators of tank and boiler heaters operations.
- Self-diagnosis and error signalling.
- Timer function to be able to schedule the machine to switch on or off at a specific time.
- Power-saving mode (stand-by): Reduction of power consumption when the machine is not in operation.
- User-selectable programmes according to equipment use (glass, crockery and bar) and machine-specific programmes.
- Machine self-cleaning programmes in models with drain pump (B) and softener (S).



Self-cleaning



Emptying



Auto-filling



Intelligent resin
regeneration

- Technical menu (via password)
 - View of all the inputs of the electronics and act on the outputs to facilitate the quick detection of problems.
 - Modification of operating parameters, such as heating temperatures, washing and rinsing times, etc.
 - Scheduled maintenance: the time between warnings to perform maintenance on the machine can be edited with the intention of reducing possible breakages and maintaining the machine's performance.
- HACCP: download HACCP information.
- Connectivity (K) as an option (Wi-fi and Ethernet).
- Sensorisation options (Z) including:
 - Chemical dosing control (DA).
 - Control of low chemical level by means of probes (L), available as an accessory, with warning on the control panel.

Concept +

Membrane keypad with 5 buttons.

Advance

Capacitive touch display. Illuminated push buttons and the multi coloured START button that changes colour depending on the machine status.

CONCEPT | C

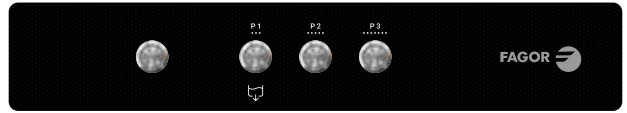

- Electromechanical interface with three or four robust backlit pushbuttons depending on the type of machine. One button for power on and the rest for programmes, the light of which indicates the selected programme (flashing) or machine is ready (steady).
- Additional programmes by long pressing of the buttons:
 - Cold rinse (C)
 - Self-cleaning (in models with drain pump- B)
 - Drain (in models with drain pump- B)
 - Extended cycle (hood type dishwasher)
- Optional two digit LED displays (T) to indicate wash and rinse temperatures, as well as alphanumeric status and error codes. They also include operating indicators for tank and boiler heaters.

Model + T



Common characteristics

Dual-flow wash pumps with soft-start

- Dual-flow wash pumps: one input and two outputs, one for each arm, without the need to split the flow to avoid power loss and reduce noise.
- The cycle starts slowly and gradually increases to maximum speed to prevent light items such as glassware and crockery from falling out.

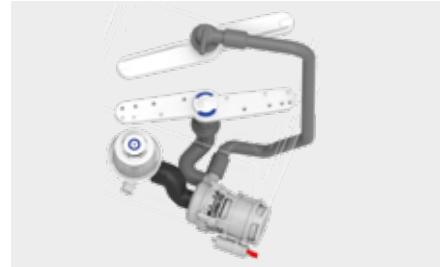

Duo-KLIP wash/rinse arms

- A combined wash and rinse arm at the same level, made of composite material, in stainless steel as option (X), preventing the two arms from getting in each other's way.
- Washing and rinsing orifices designed to reach the most inaccessible places. They spray water precisely, achieving lower water consumption, reducing electricity and chemical consumption.
- The clip-on snap-on coupling makes it easy to assemble and disassemble for cleaning.



Characteristics according to model

Rinse pump and thermostat

- Rinse even at low mains pressure (1 bar).
- The temperature of the water in the boiler is constant throughout the rinse.
- Type A nonreturn device in compliance with EN 1717.
- Accurate rinse aid dosing with a constant water flow.
- Thermostop: starts the rinse when the rinse temperature required for a hygienic wash result and correct drying of the dishes has been reached.

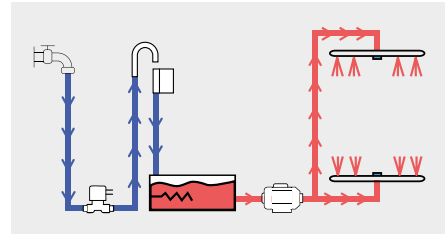

Energy Recovery System (RC)

- Minimizes the steam released to create a more comfortable working environment while using the heat from the unit to further heat the incoming water and reduce energy costs.
- The process is carried out at the end of the cycle for 40 seconds (configurable) increasing the temperature of the incoming water from 10°C to 25°C, which means that a cold water connection (15-25°C) is recommended.

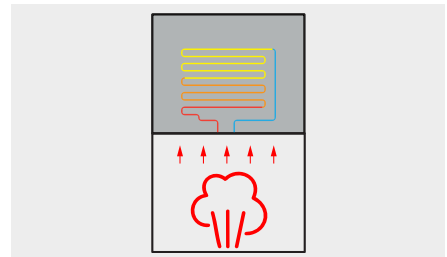

Smart softener (S)

- Integrated softener that provides continuous soft water. This allows the detergent and rinse aid to work to their full effect and considerably reduces limescale deposits in the machine.
- The user can easily refill the tank and a sensor warns when the salt tank needs to be refilled.
- Smart resin regeneration that guarantees uninterrupted washing because the process does not stop to regenerate the resin. It performs the regeneration fully automatically and invisibly for the customer. Water quality is always constant.

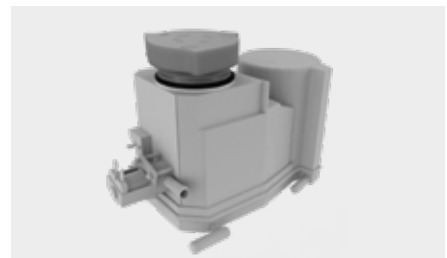

Dimensions

Glasswashers (G)

WGC-400/ WGP-400/ WGP-401

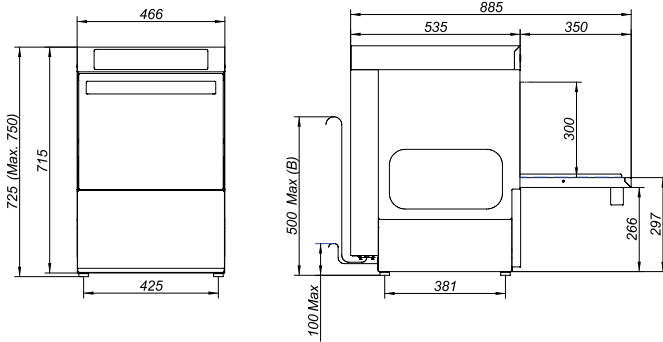

Front loading dishwashers (U)

WUC-500/ WUC-502/ WUP-502/ WUP-503

WUA-503

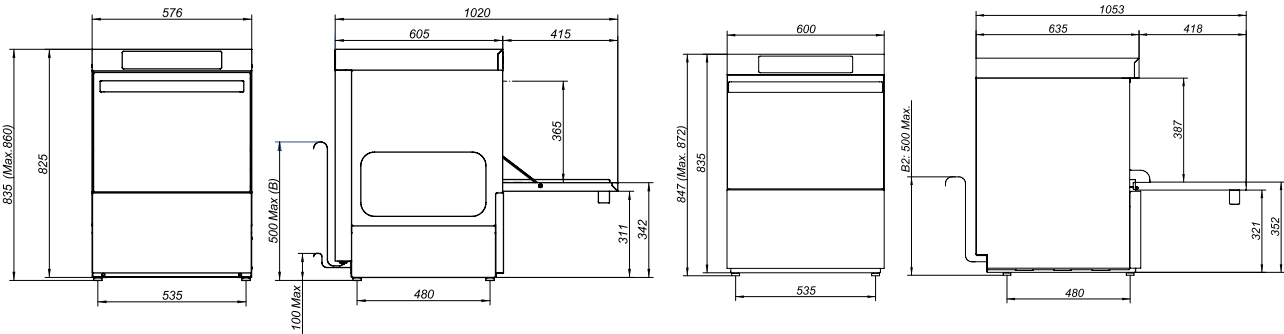

Hood type dishwashers (H)

WHC-502 (RC)/ WHP-502 (RC)/ WHP-503 (RC)

WHA-503 (RC)

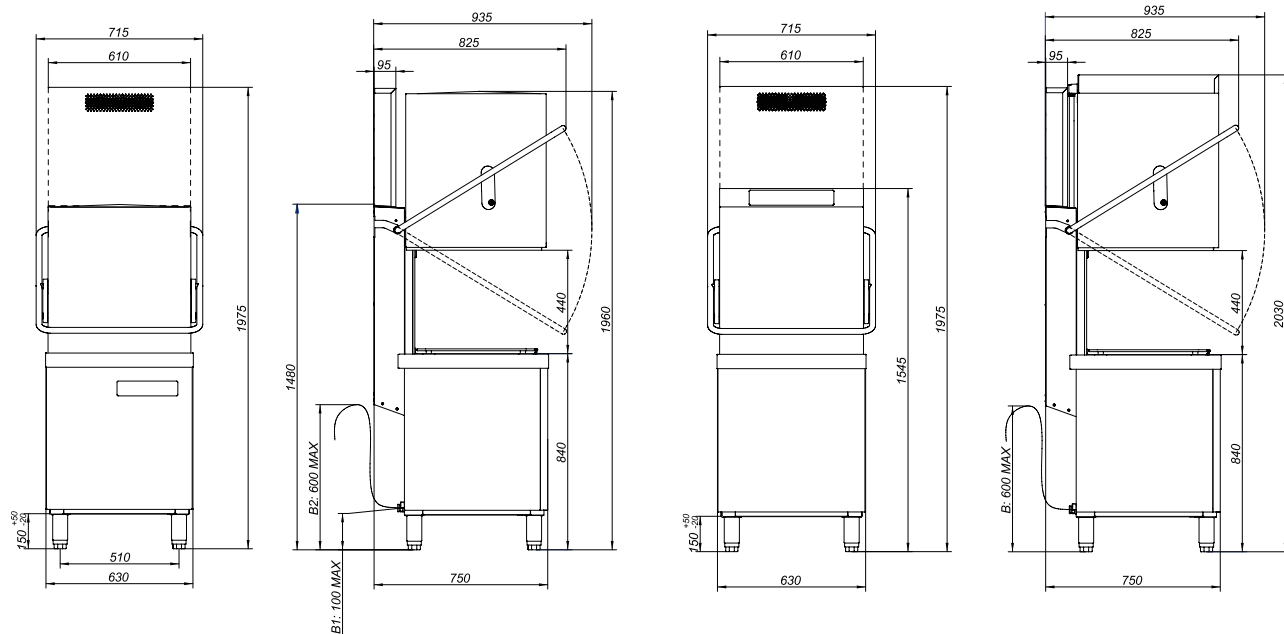

CONCEPT+

Glasswashers 400x400

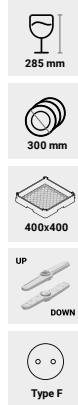
General features





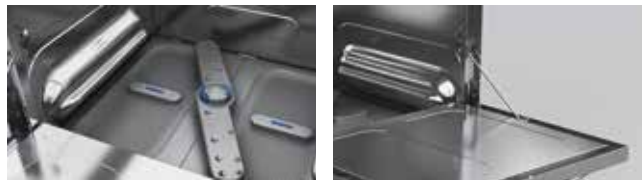





- 2.8" backlit colour liquid crystal display (TFT) and five-buttons membrane keypad.
- Stamped tank with slope for a complete drainage.
- Stamped basket guides.
- Sides of the washing chamber in partial double-skin and integral double-skin door.
- Double in stages filtration system. Composite tank surface filters as standard.
- Dual-flow wash pump with soft-start.
- Duo-KLIP upper and lower wash/rinse arms made of composite material.
- Hydraulic (in models with mains pressure WGP-400) or peristaltic (in models with rinse pump WGP-401) rinse aid dispenser as standard.
- Thermostop in models with rinse pump (WGP-401).



Technical data

Max. theoretical productivity (1)	Baskets/h	40	
Dimensions (2)	mm	466x535x725	
Net weight	Kg	34	
Tank capacity	L	9	
Boiler capacity	L	4	
Tank heater power	kW	0,8	
Boiler heater power	kW	2,4	
Wash pump power	50Hz	kW	0,29
	60Hz	kW	0,36
Rinse pump power	kW	0,13	
Drain pump power	kW	0,04	
Total power	50Hz	kW	3,49
	60Hz	kW	3,56
Total amperes	50Hz	A	15,17
	60Hz	A	15,48
Connection	Sim/Alt	Simultaneous	
Voltage	V	220-240 1N~	
Supply water pressure min. - max. in WGP-400 models	bar	2-4	
Supply water pressure min. - max. in WGP-400 S models	bar	3-4	
Supply water pressure min. - max. in WGP-401 models	bar	1-4	
Supply water temperature max.	°C	60	
Level of protection against water	IPX	3	

Programmes

PROGRAMME	DESCRIPTION	WATER CONSUMPTION (L/ CYCLE) (3)	DURATION (S)	WASH TEMPERATURE (°C)	RINSE TEMPERATURE (°C)
Programmes for GLASS - as standard					
	Light	2,1	90	60	65
	Standard	2,1	120	60	65
	Intensive	2,1	180	60	65
	Cold rinse (4)	2,1	90	65	65
Additional programmes					
Programmes for CROCKERY					
Programmes for BAR					

Codes and prices

	MODEL	CODE 50HZ	€	CODE 60HZ	€	RINSE PUMP	SMART SOFTENER (S)	COLD RINSE (C) (5)	DRAIN PUMP (B)	DETERGENT DISPENSER (D)
⊗ STOCK	WGP-400	19109781	-	19110573	-					
	WGP-400 B	19110484	-	19110574	-				X	
	WGP-400 D	19110485	-	19110575	-					X
⊗ STOCK	WGP-400 B D	19110486	-	19110576	-				X	X
	WGP-400 C	19110487	-	19110577	-			X		
	WGP-400 C B	19110488	-	19110578	-			X	X	
	WGP-400 C D	19110489	-	19110579	-			X		X
	WGP-400 C B D	19110490	-	19110580	-			X	X	X
	WGP-400 S	19110491	-	19110581	-		X			
	WGP-400 S B	19110492	-	19110582	-		X		X	
	WGP-400 S D	19110493	-	19110583	-		X			X
	WGP-400 S B D	19110494	-	19110584	-		X		X	X
	WGP-401	19108942	-	19110586	-	X				
	WGP-401 B	19110495	-	19110588	-	X			X	
	WGP-401 D	19110496	-	19110589	-	X				X
	WGP-401 B D	19110497	-	19110590	-	X			X	X
	WGP-401 S	19108391	-	19110591	-	X	X			
	WGP-401 S B	19110498	-	19110592	-	X	X		X	
	WGP-401 S D	19110499	-	19110593	-	X	X			X
	WGP-401 S B D	19110500	-	19110594	-	X	X		X	X

Options

DESCRIPTION	ABBREVIATION	€
Double-skin (6)	P	-
Round basket (+ support) 19110751 (+19110752) (7)	O	-
Glass rod basket 19107614 (8)	R	-
Connectivity	K	-
Sensorisation (9)	Z	-
UK plug (G type) (10)	CI	-
Australian model (11)	AU	-

Standard accessories

	Glass basket 19082432	pc	2
	Plates insert 19084452	pc	1
	Cutlery insert 19102721	pc	1

(1) Hot water supply at 50°C.

(2) Adjustable height (+25/+0 mm).

(3) In models with mains pressure (WGP-400), consumption may vary depending on the supply water pressure. Water consumption per programme (2 bar): 2/ 2,2/ 2,5/ 2 l/ cycle.

(4) In machines with the cold rinse option (C), the second rinse is carried out with cold water, whereas without the option, the rinse is carried out with cold water by switching off the boiler heating element.

(5) Not compatible with models with water softener (S).

(6) Increases the width of the machine by 20 mm, 10 mm in each side.

(7) This option excludes glass baskets (19082432) and plates insert (19084452) from the standard accessories.

(8) This option excludes the standard accessories.

(9) Standard in models with water softener (S).

(10) Power reduction to limit consumption to 13A.

(11) Includes Australian plug (I type) and Watermark approval.

CONCEPT

Glasswashers 400x400

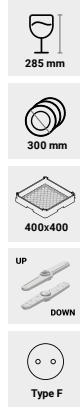

General features

- Electromechanical interface with robust backlit pushbuttons. "T" models with two digit LED displays.
- Stamped tank with slope for a complete drainage.
- Stamped basket guides.
- Sides of the washing chamber in partial double-skin and integral double-skin door.
- Double in stages filtration system. Composite tank surface filters as standard.
- Dual-flow wash pump with soft-start.
- Duo-KLIP upper and lower wash/rinse arms made of composite material.
- Rinsing with mains pressure.
- Hydraulic rinse aid dispenser as standard.

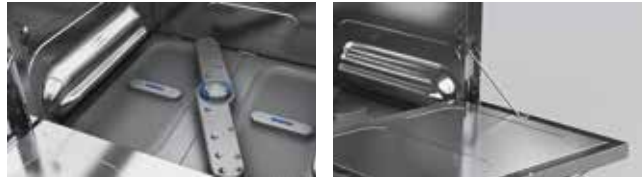

Technical data

Max. theoretical productivity (1)	Baskets/h	30	
Dimensions (2)	mm	466x535x725	
Net weight	Kg	34	
Tank capacity	L	9	
Boiler capacity	L	4	
Tank heater power	kW	0,8	
Boiler heater power	kW	2,4	
Wash pump power	50Hz	kW	0,29
	60Hz	kW	0,36
Drain pump power	kW	0,04	
Total power	50Hz	kW	3,49
	60Hz	kW	3,56
Total amperes	50Hz	A	15,17
	60Hz	A	15,48
Connection	Sim/Alt	Simultaneous	
Voltage	V	220-240 1N~	
Supply water pressure min. - max.	bar	2-4	
Supply water temperature max.	°C	60	
Level of protection against water	IPX	3	

Programmes

PROGRAMME	DESCRIPTION	WATER CONSUMPTION (L/ CYCLE) (3)	DURATION (S)	WASH TEMPERATURE (°C)	RINSE TEMPERATURE (°C)
Standard programmes					
P1	Standard	2	120	60	65
P2	Intensive	2	180	60	65



Codes and prices

	MODEL	CODE 50HZ	€	CODE 60HZ	€	LED DISPLAYS (T)	COLD RINSE (C)	DRAIN PUMP (B)	DETERGENT DISPENSER (D)
☉ STOCK	WGC-400	19106152	-	19110595	-				
	WGC-400 B	19108044	-	19110596	-			X	
	WGC-400 D	19109535	-	19110597	-				X
☉ STOCK	WGC-400 B D	19110501	-	19110598	-			X	X
	WGC-400 C	19110504	-	19110603	-		X		
	WGC-400 C B	19110505	-	19110604	-		X	X	
	WGC-400 C D	19110506	-	19110605	-		X		X
	WGC-400 C B D	19110507	-	19110606	-		X	X	X
	WGC-400 T	19109534	-	19110599	-	X			
	WGC-400 T B	19107969	-	19110600	-	X		X	
	WGC-400 T D	19110502	-	19110601	-	X			X
	WGC-400 T B D	19110503	-	19110602	-	X		X	X
	WGC-400 T C	19110508	-	19110607	-	X	X		
	WGC-400 T C B	19110509	-	19110608	-	X	X	X	
	WGC-400 T C D	19110510	-	19110609	-	X	X		X
	WGC-400 T C B D	19104296	-	19110610	-	X	X	X	X

Options

DESCRIPTION	ABBREVIATION	€
Double-skin (4)	P	-
Round basket (+ support) 19110751 (+19110752) (5)	O	-
Glass rod basket 19107614 (6)	R	-
UK plug (G type) (7)	CI	-
Australian model (8)	AU	-

Standard accessories

	Glass basket 19082432	pc	2
	Plates insert 19084452	pc	1
	Cutlery insert 19102721	pc	1

- (1) Hot water supply at 50°C.
 (2) Adjustable height (+25/+0 mm).
 (3) Consumption for a supply water pressure of 2 bar. At higher pressures the consumption will increase.
 (4) Increases the width of the machine by 20 mm, 10 mm in each side.

- (5) This option excludes glass baskets (19082432) and plates insert (19084452) from the standard accessories.
 (6) This option excludes the standard accessories.
 (7) Power reduction to limit consumption to 13A.
 (8) Includes Australian plug (I type) and Watermark approval.

Front loading dishwashers 500x500

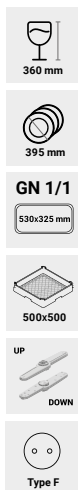

General features

- 2.8" backlit colour liquid crystal display (TFT) and capacitive touch display.
- Tank, rear door and basket guides are stamped and all edges, including the vertical ones, are rounded to facilitate the draining of impurities. There are no points where dirt accumulates.
- The machine is built with integral double-skin.
- Soundproofed and heat-resistant double-skin door.
- Cushioned counterbalanced door.
- Hygienic tank heater.
- Triple in stages filtration system. Stainless steel tank surface filter as standard and waste collection basket.
- Boiler with insulation.
- Dual-flow wash pump with soft-start.
- Duo-KLIP upper and lower wash/rinse arms made of composite material.
- Rinse pump, drain pump and peristaltic rinse aid dispenser as standard.
- Thermostop.
- Multipower as standard.



Technical data

Max. theoretical productivity (1)	Baskets/h	40
Dimensions (2)	mm	600x635x847
Net weight	Kg	60
Tank capacity	L	20
Boiler capacity	L	7
Tank heater power	kW	1
Boiler heater power	kW	5,6
Wash pump power	kW	0,68
Rinse pump power	kW	0,13
Drain pump power	kW	0,04
Total power	kW	
Total amperes	A	
Connection	Sim/Alt	Multipower
Voltage	V	
Supply water pressure min-max.	bar	1-4
Supply water temperature max.	°C	60
Supply water temperature max. in WUA-503 S models	°C	25
Level of protection against water	IPX	4

Programmes

PROGRAMME	DESCRIPTION	WATER CONSUMPTION (L / CYCLE)	DURATION (S)	WASH TEMPERATURE (°C)	RINSE TEMPERATURE (°C)
Programmes for CROCKERY- as standard					
	Light	2,3	90	60	85
	Standard	2,6	120	60	85
	Intensive	3	180	60	85
	Cutlery	3	300	65	85
Additional programmes					
Programmes for GLASS					
Programmes for BAR					

Multipower

VOLTAGE (V)	STANDARD	TOTAL AMP. (A)	TOTAL POWER (kW)	CONNECT. (Sim/Alt)	TANK POWER (kW)	BOILER POWER (kW)	PUMP POWER (kW)
220V-240V 1N~	x	15,42	3,55	Sim	1	1,87	0,68
220V-240V 1N~		19,48	4,48	Sim	1	2,8	0,68
220V-240V 1N~		23,54	5,41	Sim	1	3,73	0,68
380V-415V 3N~		15,42	7,28	Sim	1	5,6	0,68
220V-240V 3~		21,36	7,28	Sim	1	5,6	0,68



Codes and prices

	MODEL	CODE 50HZ	€	CODE 60HZ	€	RINSE PUMP	SMART SOFTENER (S)	DRAIN PUMP (B)	DETERGENT DISPENSER (D)
	WUA-503	19110511	-	19110611	-	X		X	
⊗ STOCK	WUA-503 D	19106122	-	19110612	-	X		X	X
	WUA-503 S	19110512	-	19110613	-	X	X	X	
⊗ STOCK	WUA-503 S D	19105092	-	19110614	-	X	X	X	X

Options

DESCRIPTION	ABBREVIATION	€
Stainless steel wash and rinse arms	X	-
Glass rod basket 19107616 (4)	R	-
Connectivity	K	-
Sensorisation (5)	Z	-
UK plug (G type) (6)	CI	-
Australian model (7)	AU	-

Standard accessories

	Glass basket 19000484	pc	1
	Plates basket 19000487	pc	1
	Cutlery insert 19000792	pc	1

(1) Cold water supply at 15°C and machine set to maximum power.

(2) Adjustable height (+25/+0 mm).

(3) The second rinse is carried out with cold water by switching off the boiler heating element.

(4) This option excludes the standard accessories.

(5) Standard in models with water softener (S).

(6) Power reduction to limit consumption to 13A.

(7) Includes Australian plug (I type) and Watermark approval.

CONCEPT+

Front loading dishwashers 500x500

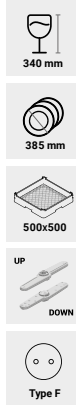
General features













- 2.8" backlit colour liquid crystal display (TFT) and five-buttons membrane keypad.
- Stamped tank with slope for a complete drainage.
- Stamped basket guides.
- Sides of the washing chamber in partial double-skin and integral double-skin door.
- Triple in stages filtration system. Composite tank surface filters as standard.
- Boiler with insulation.
- Dual-flow wash pump with soft-start.
- Duo-KLIP upper and lower wash/rinse arms made of composite material.
- Hydraulic (in models with mains pressure- WUP-502) or peristaltic (in models with rinse pump- WUP-503) rinse aid dispenser as standard.
- Thermostop in models with rinse pump (WUP-503).
- Multipower as standard.



Technical data

Max. theoretical productivity (1)	Baskets/h	40
Dimensions (2)	mm	576x605x835
Net weight	Kg	55
Tank capacity	L	20
Boiler capacity	L	7
Tank heater power	kW	2,8
Boiler heater power	kW	5,6
Wash pump power	kW	0,68
Rinse pump power	kW	0,13
Drain pump power	kW	0,04
Total power	kW	Multipower
Total amperes	A	
Connection	Sim/Alt	
Voltage	V	
Supply water pressure min. - max. in WUP-502 models	bar	2-4
Supply water pressure min. - max. in WUP-502 S models	bar	3-4
Supply water pressure min. - max. in WUP-503 models	bar	1-4
Supply water temperature max.	°C	60
Level of protection against water	IPX	3

Programmes

PROGRAMME	DESCRIPTION	WATER CONSUMPTION (L/ CYCLE) (3)	DURATION (S)	WASH TEMPERATURE (°C)	RINSE TEMPERATURE (°C)
Programmes for CROCKERY - as standard					
	Light	2,3	90	60	85
	Standard	2,6	120	60	85
	Intensive	3	180	60	85
	Cutlery	3	300	65	85
Additional programmes					
Programmes for GLASS					(4)
Programmes for BAR					

Multipower

VOLTAGE (V)	STANDARD	TOTAL AMP. (A)	TOTAL POWER (kW)	CONNECT. (Sim/Alt)	TANK POWER (kW)	BOILER POWER (kW)	PUMP POWER (kW)
220V-240V 1N~	x	15,13	3,48	Alt	2,8	2,8	0,68
220V-240V 1N~		19,19	4,41	Alt	2,8	3,73	0,68
380V-415V 3N~		15,13	6,28	Alt	2,8	5,6	0,68
220V-240V 3~		17,01	6,28	Alt	2,8	5,6	0,68



Codes and prices

	MODEL	CODE 50HZ	€	CODE 60HZ	€	RINSE PUMP	SMART SOFTENER (S)	COLD RINSE (C) (5)	DRAIN PUMP (B)	DETERGENT DISPENSER (D)
⊗ STOCK	WUP-502	19107921	-	19110615	-					
	WUP-502 B	19106121	-	19110616	-				X	
	WUP-502 D	19109548	-	19110617	-					X
⊗ STOCK	WUP-502 B D	19110513	-	19110618	-				X	X
	WUP-502 C	19110514	-	19110619	-			X		
	WUP-502 C B	19110515	-	19110620	-			X	X	
	WUP-502 C D	19110516	-	19110621	-			X		X
	WUP-502 C B D	19110517	-	19110622	-			X	X	X
	WUP-502 S	19109549	-	19110623	-		X			
	WUP-502 S B	19110518	-	19110624	-		X		X	
	WUP-502 S D	19110519	-	19110625	-		X			X
	WUP-502 S B D	19110520	-	19110626	-		X		X	X
⊗ STOCK	WUP-503	19105005	-	19110627	-	X				
	WUP-503 B	19107903	-	19110628	-	X			X	
	WUP-503 D	19109550	-	19110629	-	X				X
⊗ STOCK	WUP-503 B D	19104293	-	19110630	-	X			X	X
	WUP-503 S	19109551	-	19110631	-	X	X			
	WUP-503 S B	19107906	-	19110632	-	X	X		X	
	WUP-503 S D	19110521	-	19110633	-	X	X			X
	WUP-503 S B D	19105450	-	19110634	-	X	X		X	X

Options

DESCRIPTION	ABBREVIATION	€
Stainless steel wash and rinse arms (6)	X	-
Double-skin (7)	P	-
Glass rod basket 19107616 (8)	R	-
Connectivity	K	-
Sensorisation (9)	Z	-
UK plug (G type) (10)	Cl	-
Australian model (11)	AU	-

Standard accessories

	Glass basket 19000484	pc	1
	Plates basket 19000487	pc	1
	Cutlery insert 19000792	pc	1

- (1) Cold water supply at 15°C and machine set to maximum power.
 (2) Adjustable height (+25/+0 mm).
 (3) In models with mains pressure (WUP-502), consumption may vary depending on the supply water pressure. Water consumption per programme (2 bar): 2,2/ 2,4/ 2,7/ 2,7/ 2,7 l/cycle.
 (4) In machines with the cold rinse option (C), the second rinse is carried out with cold water, whereas without the option, the rinse is carried out with cold water by switching off the boiler heating element.

- (5) Not compatible with models with water softener (S).
 (6) Includes stainless steel tank surface filters (SF).
 (7) Increases the width of the machine by 20 mm, 10 mm in each side.
 (8) This option excludes the standard accessories.
 (9) Standard in models with water softener (S).
 (10) Power reduction to limit consumption to 13A.
 (11) Includes Australian plug (I type) and Watermark approval.

CONCEPT

Front loading dishwashers 500x500



General features

- Electromechanical interface with robust backlit pushbuttons. "T" models with two digit LED displays.
- Stamped tank with slope for a complete drainage.
- Stamped basket guides.
- Sides of the washing chamber in partial double-skin and integral double-skin door.
- Triple in stages filtration system. Composite tank surface filters as standard.
- Dual-flow wash pump with soft-start.
- Duo-KLIP upper and lower wash/rinse arms made of composite material.
- Rinsing with mains pressure.
- Hydraulic rinse aid dispenser as standard.
- Multipower as standard.



Technical data

Max. theoretical productivity (1)	Baskets/h	40
Dimensions (2)	mm	576x605x835
Net weight	Kg	55
Tank capacity	L	20
Boiler capacity	L	7
Tank heater power	kW	2,8
Boiler heater power	kW	5,6
Wash pump power	kW	0,68
Rinse pump power	kW	0,13
Drain pump power	kW	0,04
Total power	kW	
Total amperes	A	Multipower
Connection	Sim/Alt	
Voltage	V	
Supply water pressure min. - max.	bar	2-4
Supply water temperature max.	°C	60
Level of protection against water	IPX	3

Programmes

PROGRAMME	DESCRIPTION	WATER CONSUMPTION (L/ CYCLE) (3)	DURATION (S)	WASH TEMPERATURE (°C)	RINSE TEMPERATURE (°C)
Standard programmes					
P1	Light	2,2	90	60	85
P2	Standard	2,2	120	60	85
P3	Intensive	2,2	180	60	85

Multipower

VOLTAGE (V)	STANDARD	TOTAL AMP. (A)	TOTAL POWER (kW)	CONNECT. (Sim/Alt)	TANK POWER (kW)	BOILER POWER (kW)	PUMP POWER (kW)
220V-240V 1N~	x	15,13	3,48	Alt	2,8	2,8	0,68
220V-240V 1N~		19,19	4,41	Alt	2,8	3,73	0,68
380V-415V 3N~		15,13	6,28	Alt	2,8	5,6	0,68
220V-240V 3~		17,01	6,28	Alt	2,8	5,6	0,68



Codes and prices

	MODEL	CODE 50HZ	€	CODE 60HZ	€	LED DISPLAYS (T)	DRAIN PUMP (B)	DETERGENT DISPENSER (D)
☉ STOCK	WUC-502	19105105	-	19110635	-			
	WUC-502 B	19109544	-	19110636	-		X	
	WUC-502 D	19109546	-	19110637	-			X
☉ STOCK	WUC-502 B D	19110522	-	19110638	-		X	X
	WUC-502 T	19109545	-	19110639	-	X		
	WUC-502 T B	19108785	-	19110640	-	X	X	
	WUC-502 T D	19110523	-	19110641	-	X		X
	WUC-502 T B D	19110524	-	19110642	-	X	X	X

Options

DESCRIPTION	ABBREVIATION	€
Stainless steel wash and rinse arms (4)	X	-
Double-skin (5)	P	-
Glass rod basket 19107616 (6)	R	-
UK plug (G type) (7)	CI	-
Australian model (8)	AU	-

Standard accessories

	Glass basket 19000484	pc	1
	Plates basket 19000487	pc	1
	Cutlery insert 19000792	pc	1

(1) Cold water supply at 15°C and machine set to maximum power.

(2) Adjustable height (+25/+0 mm).

(3) Consumption for a supply water pressure of 2 bar. At higher pressures the consumption will increase.

(4) Includes stainless steel tank surface filters (SF).

(5) Increases the width of the machine by 20 mm, 10 mm in each side.

(6) This option excludes the standard accessories.

(7) Power reduction to limit consumption to 13A.

(8) Includes Australian plug (I type) and Watermark approval.

CONCEPT

Front loading dishwashers 500x500



General features

- Electromechanical interface with robust backlit pushbuttons. "T" models with two digit LED displays.
- Stamped tank with slope for a complete drainage.
- Stamped basket guides.
- Sides of the washing chamber in partial double-skin and integral double-skin door.
- Triple in stages filtration system. Composite tank surface filters as standard.
- Dual-flow wash pump with soft-start.
- Duo-KLIP upper and lower wash/rinse arms made of composite material.
- Rinsing with mains pressure.
- Hydraulic rinse aid dispenser as standard.

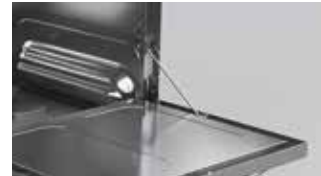

Technical data

Max. theoretical productivity (1)	Baskets/h	40
Dimensions (2)	mm	576x605x835
Net weight	Kg	55
Tank capacity	L	20
Boiler capacity	L	7
Tank heater power	kW	2,8
Boiler heater power	kW	2,8
Wash pump power	kW	0,68
Drain pump power	kW	0,04
Total power	kW	3,48
Total amperes	A	16
Connection	Sim/Alt	Alternate
Voltage	V	220-240 1N~
Supply water pressure min-max.	bar	2-4
Supply water temperature max.	°C	60
Level of protection against water	IPX	3

Programmes

PROGRAMME	DESCRIPTION	WATER CONSUMPTION (L/ CYCLE) (3)	DURATION (S)	WASH TEMPERATURE (°C)	RINSE TEMPERATURE (°C)
Standard programmes					
P1	Standard	2,2	120	60	85
P2	Intensive	2,2	180	60	85

Codes and prices

	MODEL	CODE 50HZ	€	CODE 60HZ	€	LED DISPLAYS (T)	DRAIN PUMP (B)	DETERGENT DISPENSER (D)
☉ STOCK	WUC-500	19104935	-	19110643	-			
	WUC-500 B	19109540	-	19110644	-		x	
	WUC-500 D	19109541	-	19110645	-			x
☉ STOCK	WUC-500 B D	19110525	-	19110646	-		x	x
	WUC-500 T	19105590	-	19110647	-	x		
	WUC-500 T B	19110526	-	19110648	-	x	x	
	WUC-500 T D	19110527	-	19110649	-	x		x
	WUC-500 T B D	19110528	-	19110650	-	x	x	x

Options

DESCRIPTION	ABBREVIATION	€
Stainless steel wash and rinse arms (4)	X	-
Double-skin (5)	P	-
Glass rod basket 19107616 (6)	R	-
UK plug (G type) (7)	CI	-
Australian model (8)	AU	-

Standard accessories

	Glass basket 19000484	pc	1
	Plates basket 19000487	pc	1
	Cutlery insert 19000792	pc	1

(1) Hot water supply at 50°C.

(2) Adjustable height (+25/+0 mm).

(3) Consumption for a supply water pressure of 2 bar. At higher pressures the consumption will increase.

(4) Includes stainless steel tank surface filters (SF).

(5) Increases the width of the machine by 20 mm, 10 mm in each side.

(6) This option excludes the standard accessories.

(7) Power reduction to limit consumption to 13A.

(8) Includes Australian plug (I type) and Watermark approval.

Hood type dishwashers 500x500



General features

- 2.8" backlit colour liquid crystal display (TFT) and capacitive touch display.
- Fully stamped tank with no welds or sharp edges.
- Double-skin hood with thermo-acoustic insulation and metal runners to reduce lifting effort and noise level.
- Maximum visibility thanks to the top position of the control panel.
- Triple stage filtration system. Composite tank surface filter as standard and waste collection basket.
- Boiler with insulation.
- Dual-flow wash pump with soft-start.
- Duo-KLIP upper and lower wash/rinse arms made of composite material.
- Rinse pump, drain pump and peristaltic rinse aid dispenser as standard.
- Thermostop.
- Multipower as standard.



Technical data

Max. theoretical productivity (1)	Baskets/h	60
Dimensions (2)	mm	630x750x1.545
Dimensions with handle	mm	715x935
Height with hood opened	mm	2.030
Height with energy recovery (RC)	mm	1.975
Net weight	Kg	116
Net weight with energy recovery (RC)	Kg	135
Tank capacity	L	28
Boiler capacity	L	10
Tank heater power	kW	2,1
Boiler heater power	kW	9
Wash pump power	kW	0,75
Rinse pump power	kW	0,13
Drain pump power	kW	0,1
Total power	kW	
Total amperes	A	
Connection	Sim/Alt	Multipower
Voltage	V	
Supply water pressure min-max.	bar	1-4
Supply water temperature max.	°C	60
Supply water temperature max. RC and S models	°C	25
Level of protection against water	IPX	4

Programmes

PROGRAMME	DESCRIPTION	WATER CONSUMPTION (L/ CYCLE)	DURATION (S) (3)	WASH TEMPERATURE (°C)	RINSE TEMPERATURE (°C)
Programmes for CROCKERY- as standard					
	Light	2,3	60	60	85
	Standard	2,6	90	60	85
	Intensive	3	180	60	85
	Extended	3	480	60	85
	Cutlery	3	300	65	85
Additional programmes					
Programmes for GLASS					
Programmes for BAR					

Multipower

VOLTAGE (V)	STANDARD	TOTAL AMP. (A)	TOTAL POWER (kW)	CONNECT. (Sim/Alt)	TANK POWER (kW)	BOILER POWER (kW)	PUMP POWER (kW)
220V-240V 1N~		27,39	6,3	Sim	1,05	4,5	0,75
220V-240V 1N~		35,43	8,15	Sim	1,4	6	0,75
380V-415V 3N~	x	19,35	11,85	Sim	2,1	9	0,75
220V-240V 3~		31,12	11,85	Sim	2,1	9	0,75

Codes and prices

	MODEL	CODE 50HZ	€	CODE 60HZ	€	RINSE PUMP	ENERGY RECOVERY (RC)	SMART SOFTENER (S)	DRAIN PUMP (B)	DETERGENT DISPENSER (D)
	WHA-503	19105006	-	19110651	-	X			X	
⊗ STOCK	WHA-503 D	19108744	-	19110652	-	X			X	X
	WHA-503 RC	19109461	-	19110653	-	X	X		X	
	WHA-503 RC D	19110529	-	19110654	-	X	X		X	X
	WHA-503 S	19109460	-	19110655	-	X		X	X	
⊗ STOCK	WHA-503 S D	19105482	-	19110656	-	X		X	X	X
	WHA-503 S RC	19107905	-	19110657	-	X	X	X	X	
⊗ STOCK	WHA-503 S RC D	19110530	-	19110658	-	X	X	X	X	X

Options

DESCRIPTION	ABBREVIATION	€
Stainless steel wash and rinse arms	X	-
Stainless steel surface filter	SF	-
Glass rod basket 19107616 (5)	R	-
Connectivity	K	-
Sensorisation (6)	Z	-
Australian model (7)	AU	-
Marine (8)	400V-440V 3~	-

Standard accessories

	Glass basket 19000484	pc	1
	Plates basket 19000487	pc	1
	Cutlery insert 19000792	pc	1

(1) Cold water supply at 15°C.

(2) Adjustable height (-20/+50 mm).

(3) In models with energy recovery system (RC), the cycle time is extended by approximately 30s.

(4) The second rinse is carried out with cold water by switching off the boiler heating element.

(5) This option excludes the standard accessories.

(6) Standard in models with water softener (S) or Energy Recovery System (RC).

(7) Includes Watermark approval.

(8) Select the machine with the appropriate frequency and then add the option.

Hood type dishwashers 500x500



General features

- 2.8" backlit colour liquid crystal display (TFT) and five-buttons membrane keypad.
- Fully stamped tank with no welds or sharp edges.
- Single-skin hood, which slides smoothly on metal runners that reduce lifting effort and noise level.
- Double in stages filtration system. Composite tank surface filter as standard.
- Boiler with insulation.
- Dual-flow wash pump with soft-start.
- Duo-KLIP upper and lower wash/rinse arms made of composite material.
- Hydraulic (in models with mains pressure- WHP-502) or peristaltic (in models with rinse pump- WHP-503) rinse aid dispenser as standard.
- Thermostop in models with rinse pump (WHP-503).
- Multipower as standard.



Technical data

Max. theoretical productivity (1)	Baskets/h	60
Dimensions (2)	mm	630x750x1.480
Dimensions with handle	mm	715x935
Height with hood opened	mm	1.960
Height with energy recovery (RC)	mm	1.975
Net weight	Kg	97
Net weight with energy recovery (RC)	Kg	113
Tank capacity	L	33
Boiler capacity in WHP-502 models	L	9
Boiler capacity in WHP-503 models	L	10
Tank heater power	kW	4,5
Boiler heater power	kW	9
Wash pump power	kW	0,75
Rinse pump power	kW	0,13
Drain pump power	kW	0,1
Total power	kW	
Total amperes	A	
Connection	Sim/Alt	Multipower
Voltage	V	
Supply water pressure min. - max. in WHP-502	bar	2-4
Supply water pressure min. - max. in WHP-502 S / S RC	bar	3-4
Supply water pressure min. - max. in WHP-503 models	bar	1-4
Supply water temperature max.	°C	60
Supply water temperature max. RC models	°C	25
Level of protection against water	IPX	4

Programmes

PROGRAMME	DESCRIPTION	WATER CONSUMPTION (L/ CYCLE) (3)	DURATION (S) (4)	WASH TEMPERATURE (°C)	RINSE TEMPERATURE (°C)
Programmes for CROCKERY - as standard					
	Light	2,3	60	60	85
	Standard	2,6	90	60	85
	Intensive	3	180	60	85
	Extended	3	480	60	85
	Cutlery	3	300	65	85
Additional programmes					
Programmes for GLASS					
Programmes for BAR					

Multipower

VOLTAGE (V)	STANDARD	TOTAL AMP. (A)	TOTAL POWER (kW)	CONNECT. (Sim/Alt)	TANK POWER (kW)	BOILER POWER (kW)	PUMP POWER (kW)
220V-240V 1N~		22,83	5,25	Alt	2,25	4,5	0,75
220V-240V 1N~		29,35	6,75	Alt	3	6	0,75
220V-240V 1N~		32,61	7,5	Sim	2,25	4,5	0,75
220V-240V 1N~		42,39	9,75	Sim	3	6	0,75
380V-415V 3N~		16,30	9,75	Alt	4,5	9	0,75
380V-415V 3N~	x	22,83	14,25	Sim	4,5	9	0,75
220V-240V 3~		25,85	9,75	Alt	4,5	9	0,75
220V-240V 3~		37,15	14,25	Sim	4,5	9	0,75

Codes and prices

	MODEL	CODE 50HZ	€	CODE 60HZ	€	RINSE PUMP	ENERGY RECOVERY (RC)	SMART SOFTENER (S)	DRAIN PUMP (B)	DETERGENT DISPENSER (D)
⊙ STOCK	WHP-502	19104995	-	19110659	-					
	WHP-502 B	19105442	-	19110660	-				X	
	WHP-502 D	19109453	-	19110661	-					X
⊙ STOCK	WHP-502 B D	19110531	-	19110662	-				X	X
⊙ STOCK	WHP-502 RC	19109455	-	19110663	-		X			
	WHP-502 RC B	19110532	-	19110664	-		X		X	
	WHP-502 RC D	19110533	-	19110665	-		X			X
	WHP-502 RC B D	19110534	-	19110666	-		X		X	X
	WHP-502 S B	19109454	-	19110668	-			X	X	
	WHP-502 S B D	19110537	-	19110670	-			X	X	X
	WHP-502 S RC B	19110539	-	19110672	-		X	X	X	
	WHP-502 S RC B D	19110541	-	19110674	-		X	X	X	X
⊙ STOCK	WHP-503	19104996	-	19110675	-	X				
	WHP-503 B	19108550	-	19110676	-	X			X	
	WHP-503 D	19109456	-	19110677	-	X				X
⊙ STOCK	WHP-503 B D	19110542	-	19110678	-	X			X	X
	WHP-503 RC	19109459	-	19110679	-	X	X			
	WHP-503 RC B	19110543	-	19110680	-	X	X		X	
	WHP-503 RC D	19110544	-	19110681	-	X	X			X
	WHP-503 RC B D	19110545	-	19110682	-	X	X		X	X
	WHP-503 S B	19109457	-	19110684	-	X		X	X	
	WHP-503 S B D	19110548	-	19110686	-	X		X	X	X
	WHP-503 S RC B	19110550	-	19110688	-	X	X	X	X	
	WHP-503 S RC B D	19110552	-	19110690	-	X	X	X	X	X

Options

DESCRIPTION	ABBREVIATION	€
Stainless steel wash and rinse arms	X	-
Stainless steel surface filter	SF	-
Double-skin	P	-
Glass rod basket 19107616 (6)	R	-
Connectivity	K	-
Sensorisation (7)	Z	-
Australian model (8)	AU	-
Marine (9)	400V-440V 3~	-

Standard accessories

	Glass basket 19000484	pc	1
	Plates basket 19000487	pc	1
	Cutlery insert 19000792	pc	1

(1) Cold water supply at 15°C.

(2) Adjustable height (-20/+50 mm).

(3) In models with mains pressure (WHP-502), consumption may vary depending on the supply water pressure. Water consumption per programme (2 bar): 2,2/ 2,4/ 2,8/ 2,8/ 2,8/ 2,8 l/cycle.

(4) In models with energy recovery system (RC), the cycle time is extended by approximately 30s.

(5) The second rinse is carried out with cold water by switching off the boiler heating element.

(6) This option excludes the standard accessories.

(7) Standard in models with water softener (S) or Energy Recovery System (RC).

(8) Includes Watermark approval.

(9) Select the machine with the appropriate frequency and then add the option.

CONCEPT

Hood type dishwashers 500x500



General features

- Electromechanical interface with robust backlit pushbuttons. "T" models with two digit LED displays.
- Fully stamped tank with no welds or sharp edges.
- Single-skin hood, which slides smoothly on metal runners that reduce lifting effort and noise level.
- Double in stages filtration system. Composite tank surface filter as standard.
- Dual-flow wash pump with soft-start.
- Duo-KLIP upper and lower wash/rinse arms made of composite material.
- Rinsing with mains pressure.
- Hydraulic rinse aid dispenser as standard.

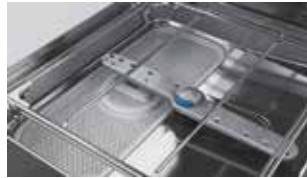

Technical data

Max. theoretical productivity (1)	Baskets/h	40	
Dimensions (2)	mm	630x750x1.480	
Dimensions with handle	mm	715x935	
Height with hood opened	mm	1.960	
Height with energy recovery (RC)	mm	1.975	
Net weight	Kg	97	
Net weight with energy recovery (RC)	Kg	113	
Tank capacity	L	33	
Boiler capacity	L	9	
Tank heater power	kW	3	
Boiler heater power	kW	6	
Wash pump power	kW	0,75	
Rinse pump power	kW	0,13	
Drain pump power	kW	0,1	
Total power	kW		
Total amperes	A	Voltage and power options	
Connection	Sim/Alt		
Voltage	V		
Supply water pressure min. - max.	bar		2-4
Supply water temperature max.	°C		60
Supply water temperature max. RC models	°C	25	
Level of protection against water	IPX	4	

Programmes

PROGRAMME	DESCRIPTION	WATER CONSUMPTION (L/ CYCLE) (3)	DURATION (S) (4)	WASH TEMPERATURE (°C)	RINSE TEMPERATURE (°C)
Standard programmes					
P1	Light	2,2	90	60	85
P2	Standard	2,2	120	60	85
P3	Intensive	2,2	180	60	85
↻	Extended	2,2	480	60	85

Voltage and power options

VOLTAGE (V)	STANDARD	TOTAL AMP. (A)	TOTAL POWER (kW)	CONNECT. (Sim/Alt)	TANK POWER (kW)	BOILER POWER (kW)	PUMP POWER (kW)
380V-415V 3N~		11,96	6,75	Alt	3	6	0,75
380V-415V 3N~	x	16,3	9,75	Sim	3	6	0,75
220V-240V 3~		18,32	6,75	Alt	3	6	0,75
220V-240V 3~		25,85	9,75	Sim	3	6	0,75



Codes and prices

	MODEL	CODE 50HZ	€	CODE 60HZ	€	ENERGY RECOVERY (RC)	LED DISPLAYS (T)	DRAIN PUMP (B)	DETERGENT DISPENSER (D)
⊗ STOCK	WHC-502	19103824	-	19110691	-				
	WHC-502 B	19109394	-	19110692	-			X	
	WHC-502 D	19109401	-	19110693	-				X
⊗ STOCK	WHC-502 B D	19110553	-	19110694	-			X	X
	WHC-502 T	19105440	-	19110695	-		X		
	WHC-502 T B	19110554	-	19110696	-		X	X	
	WHC-502 T D	19110555	-	19110697	-		X		X
	WHC-502 T B D	19110556	-	19110698	-		X	X	X
	WHC-502 T RC	19109445	-	19110699	-	X	X		
	WHC-502 T RC B	19110557	-	19110700	-	X	X	X	
	WHC-502 T RC D	19110558	-	19110701	-	X	X		X
	WHC-502 T RC B D	19110559	-	19110702	-	X	X	X	X

Options

DESCRIPTION	ABBREVIATION	€
Stainless steel wash and rinse arms	X	-
Stainless steel surface filter	SF	-
Double-skin	P	-
Glass rod basket 19107616 (5)	R	-
Australian model (6)	AU	-
Marine (7)	400V-440V 3~	-

Standard accessories

	Glass basket 19000484	pc	1
	Plates basket 19000487	pc	1
	Cutlery insert 19000792	pc	1

(1) Cold water supply at 15°C.

(2) Adjustable height (-20/+50 mm).

(3) Consumption for a supply water pressure of 2 bar. At higher pressures the consumption will increase.

(4) In models with energy recovery system (RC), the cycle time is extended by approximately 30s.

(5) This option excludes the standard accessories.

(6) Includes Watermark approval.

(7) Select the machine with the appropriate frequency and then add the option.

Front loading dishwashers 500x500



General features



- 2.8" backlit colour liquid crystal display (TFT) and five-buttons membrane keypad.
- Stamped tank with slope for a complete drainage.
- Stamped basket guides.
- The machine is built with integral double-skin.
- Triple in stages filtration system. Stainless steel tank surface filters as standard.
- Boiler with insulation.
- Dual-flow wash pump with soft-start.
- Stainless steel Duo-KLIP upper and lower wash/rinse arms.
- Rinse pump and peristaltic rinse aid dispenser as standard.
- Thermostop.



Technical data

Max. theoretical productivity (1)	Baskets/h	40
Dimensions (2)	mm	596x605x835
Net weight	Kg	58
Tank capacity	L	20
Boiler capacity	L	7
Tank heater power	kW	4,5
Boiler heater power	kW	5,6
Wash pump power	kW	0,68
Rinse pump power	kW	0,13
Drain pump power	kW	0,04
Total power	kW	
Total amperes	A	Voltage and power options
Connection	Sim/Alt	
Voltage	V	
Supply water pressure min. - max.	bar	1-4
Supply water temperature max.	°C	60
Level of protection against water	IPX	3

Programmes

PROGRAMME	DESCRIPTION	WATER CONSUMPTION (L/ CYCLE)	DURATION (S)	WASH TEMPERATURE (°C)	RINSE TEMPERATURE (°C)
Standard programmes					
	Light	2,1	90	60	85
	Standard	2,3	120	60	85
A_{0}^{30}	Sanitary programme according to UNE-EN ISO 15883-1/3, MODE A0=30.	2,3	automatic	72	85
A_{0}^{60}	Sanitary programme according to UNE-EN ISO 15883-1/3, MODE A0=60.	2,9	automatic	72	85

Voltage and power options

VOLTAGE (V)	STANDARD	TOTAL AMP. (A)	TOTAL POWER (kW)	CONNECT. (Sim/Alt)	TANK POWER (kW)	BOILER POWER (kW)	PUMP POWER (kW)
380V-415V 3N~	x	17,59	10,78	Sim	4,5	5,6	0,68
220V-240V 3~		28,31	10,78	Sim	4,5	5,6	0,68

Codes and prices

MODEL	CODE 50HZ	€	CODE 60HZ	€	RINSE PUMP	DRAIN PUMP (B)	DETERGENT DISPENSER (D)
WUP-503 SN	19105091	-	19110703	-	X		
WUP-503 SN B	19110560	-	19110704	-	X	X	
WUP-503 SN D	19110561	-	19110705	-	X		X
WUP-503 SN B D	19110562	-	19110706	-	X	X	X

Options

DESCRIPTION	ABBREVIATION	€
Glass rod basket 19107616 (3)	R	-
Connectivity	K	-
Sensorisation	Z	-
Australian model (4)	AU	-

Standard accessories

	Glass basket 19000484	pc	1
	Plates basket 19000487	pc	1
	Cutlery insert 19000792	pc	1

- (1) Cold water supply at 15°C.
 (2) Adjustable height (+25/+0 mm).
 (3) This option excludes the standard accessories.
 (4) Includes Watermark approval.

Hood type dishwashers 500x500



General features



- 2.8" backlit colour liquid crystal display (TFT) and five-buttons membrane keypad.
- Fully stamped tank with no welds or sharp edges.
- Double-skin hood with thermo-acoustic insulation and metal runners that reduce lifting effort and noise level.
- Double in stages filtration system. Stainless steel surface filter as standard.
- Boiler with insulation.
- Dual-flow wash pump with soft-start.
- Stainless steel Duo-KLIP upper and lower wash/rinse arms.
- Rinse pump and peristaltic rinse aid dispenser as standard.
- Thermostop.



Technical data

Max. theoretical productivity (1)	Baskets/h	60
Dimensions (2)	mm	630x750x1.480
Dimensions with handle	mm	715x935
Height with hood opened	mm	1.960
Height with energy recovery (RC)	mm	1.975
Net weight	Kg	97
Net weight with energy recovery (RC)	Kg	113
Tank capacity	L	33
Boiler capacity	L	10
Tank heater power	kW	4,5
Boiler heater power	kW	9
Wash pump power	kW	0,75
Rinse pump power	kW	0,13
Drain pump power	kW	0,1
Total power	kW	
Total amperes	A	
Connection	Sim/Alt	Voltage and power options
Voltage	V	
Supply water pressure min. - max.	bar	1-4
Supply water temperature max.	°C	60
Supply water temperature max RC models	°C	25
Level of protection against water	IPX	4

Programmes

PROGRAMME	DESCRIPTION	WATER CONSUMPTION (L/ CYCLE)	DURATION (S) (3)	WASH TEMPERATURE (°C)	RINSE TEMPERATURE (°C)
Standard programmes					
	Light	2,1	60	60	85
	Standard	2,3	90	60	85
A_{0}^{30}	Sanitary programme according to UNE-EN ISO 15883-1/3, MODE A0=30.	2,3	automatic	74	85
A_{0}^{60}	Sanitary programme according to UNE-EN ISO 15883-1/3, MODE A0=60.	2,9	automatic	74	85

Voltage and power options

VOLTAGE (V)	STANDARD	TOTAL AMP. (A)	TOTAL POWER (kW)	CONNECT. (Sim/Alt)	TANK POWER (kW)	BOILER POWER (kW)	PUMP POWER (kW)
380V-415V 3N~	x	22,83	14,25	Sim	4,5	9	0,75
220V-240V 3~		37,15	14,25	Sim	4,5	9	0,75



Codes and prices

MODEL	CODE 50HZ	€	CODE 60HZ	€	RINSE PUMP	ENERGY RECOVERY (RC)	DRAIN PUMP (B)	DETERGENT DISPENSER (D)
WHP-503 SN	19110563	-	19110707	-	X			
WHP-503 SN B	19110564	-	19110708	-	X		X	
WHP-503 SN D	19110565	-	19110709	-	X			X
WHP-503 SN B D	19110566	-	19110710	-	X		X	X
WHP-503 SN RC	19108549	-	19110711	-	X	X		
WHP-503 SN RC B	19110567	-	19110712	-	X	X	X	
WHP-503 SN RC D	19110568	-	19110713	-	X	X		X
WHP-503 SN RC B D	19110569	-	19110714	-	X	X	X	X

Options

DESCRIPTION	ABBREVIATION	€
Glass rod basket 19107616 (4)	R	-
Connectivity	K	-
Sensorisation (5)	Z	-
Australian model (6)	AU	-
Marine (7)	400V-440V 3~	-

Standard accessories

	Glass basket 19000484	pc	1
	Plates basket 19000487	pc	1
	Cutlery insert 19000792	pc	1

(1) Cold water supply at 15°C.

(2) Adjustable height (-20/+50 mm).

(3) In models with energy recovery system (RC), the cycle time is extended by approximately 30s.

(4) This option excludes the standard accessories.

(5) Standard in models with Energy Recovery System (RC).

(6) Includes Watermark approval.

(7) Select the machine with the appropriate frequency and then the add option.

Accessories

Detergent dispenser and drain pump kit

	MODEL	CODE	APPLIES TO	DESCRIPTION	POWER (KW)	€
	WAD	19110571	Glasswashers, front loading dishwashers and hood type dishwashers	Peristaltic detergent dispenser	-	-
	WAB-GU	19110572	Glasswashers and front loading dishwashers	Drain pump kit 50/60 Hz	0,04	-
	WAB-H	19110082	Hood type dishwashers	Drain pump kit 50/60 Hz	0,1	-

Rinse aid/detergent low level sensor kit

	MODEL	CODE	APPLIES TO	DESCRIPTION	€
	WALS	19111334	Concept + and Advance range with sensorisation option (Z).	Rinse aid/detergent level sensor kit (1 piece)	-

Connectivity Kit

	MODEL	CODE	APPLIES TO	DESCRIPTION	€
	KIT FAGORKONNECT warewashing	19110570	Concept + and Advance range	Wi-fi and Ethernet	-

Stands

	MODEL	CODE	APPLIES TO	DESCRIPTION	DIMENSIONS	€
	WAGB-S	19105217	Glasswasher		465x433x90	-
	WAGB-XL	19105218	Glasswasher	Capacity for 2 baskets 400x400	470x465x505	-
	WAUB-XL	19105219	Front loading dishwasher	Capacity for 2 baskets 500x500	580x565x400	-

Tables for hood-type dishwashers

- Worktop made of stainless steel with satin finish.
- Welded bowl 450 x 450 x 250 mm.
- Shower unit not included, but provided with a hole to fit it.
- Sorting hole with black rubber ring flush with the worktop for disposal of waste into a rubbish bin (not included).
- Splashback 100 x 15 mm.
- Square stainless steel legs 40 x 40 mm.
- Frame height 850 mm with height-adjustable stainless steel legs (-10 mm / + 50 mm).
- Supplied disassembled.

Tables without bowl



Tables without bowl and with splashback



DIMENSIONS (mm)	MODEL	CODE	€	RIGHT			LEFT			
				DIMENSIONS	MODEL	CODE	€	MODEL	CODE	€
700x620x850	WHTC-70	19104311	-	700x740x850	WHTW-70 R	19104313	-	WHTW-70 L	19104312	-
1.200x620x850	WHTC-120	19105486	-	1.200x740x850	WHTW-120 R	19104315	-	WHTW-120 L	19104314	-

Tables with bowl and splashback



DIMENSIONS (mm)	RIGHT			LEFT		
	MODEL	CODE	€	MODEL	CODE	€
700x740x850	WHTWB-70 R	19104319	-	WHTWB-70 L	19104318	-
1.200x740x850	WHTWB-120 R	19104321	-	WHTWB-120 L	19104320	-

Tables with bowl, sorting hole and splashback



DIMENSIONS (mm)	RIGHT			LEFT		
	MODEL	CODE	€	MODEL	CODE	€
1.200x740x850	WHTWBS-120 R	19104323	-	WHTWBS-120 L	19104322	-
1.500x740x850	WHTWBS-150 R	19104325	-	WHTWBS-150 L	19104324	-

Side closure

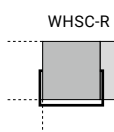

RIGHT			LEFT		
MODEL	CODE	€	MODEL	CODE	€
WHSC-R	19104327	-	WHSC-L	19104326	-

Union element for hood dishwashers



MODEL	CODE	DIMENSIONS (mm)	€
WHTJ-14	19104316	140	-
WHTJ-62	19104317	640	-

Water treatment

What you can achieve with treatment of water

Most of the water that comes out of the tap seems perfectly pure, however it may contain invisible contaminants.

Removing these elements has a decisive influence on water quality.

Calcium and magnesium (hardness) are eliminated and the useful life of the equipment is significantly extended, reducing maintenance interventions and the use of detergents and rinse aids.

	SOFTENER	REVERSE OSMOSIS
EXCELLENT WASH		X
SAVING DETERGENTS	X	X
REDUCES GLASS AND CERAMICS WEAR		X
PROTECTS THE MACHINE	X	X
GOODBYE MANUAL DRYING		X

Water treatment methods

Water treatment occurs mainly in two ways.

SOFTENER

The result obtained by using the water softener is to eliminate the calcium Ca^{2+} and magnesium Mg^{2+} ions, responsible for the hardness of the water. This effectively prevents the formation of encrustations which over time reduce the performance of the machines and cause malfunctions.

REVERSE OSMOSIS

Thanks to the very high degree of filtration that characterizes reverse osmosis machines, it is possible to obtain water with high quality characteristics. Water, passing through one or more membranes, is deprived not only of the elements that determine its hardness, but also of all substances contaminants, responsible, for example, for unwanted odors and flavors.

For excellent results and long maintenance intervals, the two technologies can be combined.



Manual water softeners

CODE	DESCRIPTION	CAPACITY OF REGENERATION (*)	DIMENSIONS (mm)	€	
	19004690	DESCALING KIT 12 L.	1.050 litres between 2 regenerations	Ø 185x560 mm	-
	19004798	DESCALING KIT 16 L.	1.400 litres between 2 regenerations	Ø 185x740 mm	-

Reverse osmosis

Great advantages of reverse osmosis:

- It reduces detergent use by up to 60% and rinse aid by 70-100%.
- It polishes plates, glasses and cutlery, obtaining a mark-free washing result since it does not require drying after the wash.
- It extends the life of glassware and dishes since it reduces corrosion.
- It protects the machinery, extending its life.



Inlet water conditions:

- Type of inlet water: drinking water.
- Inlet water temperature: 5 °C - 35 °C.
- Minimum flow: 400 l/h.
- Supply pressure: 1,5-6 bar.
- Maximum conductivity of inlet water: 1200 µS / cm.
- Maximum inlet water hardness: up to 35°f with pH below 8,5 and up to 27°f with pH above 8,5.
- As of 10°dH 15°dH or 27°f, we recommend installing a water softening system prior to osmosis to prevent blockage of the membrane.
- High-flow reverse osmosis system.
- Vertical or horizontal installation.

- Flow: 120 l/h at 15°C.
- Recovery rate from 25% to 60%.
- Typical rejection rate: 95 %.
- Electrical connection 230V ~ 50/60Hz.
- Prefilter that reduces and eliminates water turbidity, chlorine, tastes and smells. Its nominal filtration rate is 5 microns.
- Easy to install.
- Prefilter change alarm.
- Water leak alarm.
- Low-pressure alarm at system entrance.
- Manual bypass valve.

ONLY VALID FOR: WGP-401, WUA-503, WUP-503, WHA-503 and WHP-503

MODEL	CODE	FLOW 15°C (L/H)	NUMBER OF MEMBRANES	VOLTAGE (V)	FREQUENCY (HZ)	POWER (KW)	DIMENSIONS (mm)	€
REVO-120	19076763	120	2	230	50	0,33	145 x 560 x 455	-

MODEL	CODE	DESCRIPTION	€
PREF-PACK6	19076764	Pack of 6 units of rapid-connection cartridges with extruded carbon block filter	-



Robust and powerful
for high degrees
of cleanliness.



Access the website

Utensil washers

Utensil washers	209
Accessories	212

Utensil washers



- 5" backlit colour LCD display.
- The tank is stamped and inclined for complete drainage. The washing chamber is free of interior pipes, edges and holes where dirt can accumulate. In WLP-61 model, the tank is welded.
- The machine is built with integral double-skin.
- Soundproofed and heat-resistant double-skin door.
- Counter-balanced, cushioned door for easy opening and closing (except for WLP-61 model).
- Stainless steel tank surface filter, retains coarse dirt.
- Polypropylene basket filter, except on WLP-61 models, which is in an easily accessible position so that the operator can remove and empty it

- in a few seconds.
- Suction filter in polypropylene that blocks the lightest dirt, protecting the washing pump. In WLP-61 model double suction filter.
- Dual-flow wash pump. 2 pumps in WLP-130 model.
- Lower and upper "3-spoke" stainless steel wash arms. In WLP-61 "2-spoke" in lower side.
- Rinse pump, drain pump, peristaltic rinse aid dispenser and peristaltic detergent dispenser as standard.
- Rod basket as standard accessory.

Technical data

TECHNICAL DATA		WLP-61	WLP-62	WLP-63	WLP-70	WLP-130
Maximum theoretical productivity	Baskets/h	30	30	30	30	30
Dimensions	mm	600x700x1.290	719x782x1.727	719x782x1.927	853x857x1.959	1.465x857x1.959
Height with door open	mm	-	1.997	2.243	2.274	2.274
Height with energy recovery (RC)	mm	-	1.956	2.156	2.187	2.187
Usable height	mm	405	650	850	850	850
Net weight	Kg	71	148	173	181	301
Net weight with energy recovery (RC)	Kg	-	174	199	207	327
Tank capacity	L	23	37	37	68	131
Boiler capacity	L	6	12	12	12	17
Tank heater power	kW	2,1	3	3	8	10,5
Boiler heater power	kW	6	6	6	8	10,5
Washing pump power	kW	0,7	1,5	1,5	2,7	2,7x2
Rinsing pump power	kW	0,2	0,2	0,2	0,2	0,2x2
Drainage pump power	kW	0,1	0,1	0,1	0,1	0,1
Total power	kW	6,7	7,5	7,5	10,7	15,9
Fuse protection	A	16	16	16	25	32
Connection	Sim/Alt	Alternate	Alternate	Alternate	Alternate	Alternate
Voltage	V	380 V-415 V / 3N~	380 V-415 V / 3N~	380 V-415 V / 3N~	380 V-415 V / 3N~	380 V-415 V / 3N~
Frequency	Hz	50	50	50	50	50
Supply water pressure min-max.	bar	1-6	1-6	1-6	1-6	1-6
Supply water temperature min-max.	°C	15-60	15-60	15-60	15-60	15-60
Supply water temperature min-max RC models	°C	-	15-25	15-25	15-25	15-25
Level of protection against water	IPX	4	4	4	4	4

Programmes

PROGRAMME	DESCRIPTION	WATER CONSUMPTION (L / CYCLE)					DURATION (S)	WASH TEMPERATURE (°C)	RINSE TEMPERATURE (°C)
		WLP-61	WLP-62	WLP-63	WLP-70	WLP-130			
Standard programmes									
Professional 2	Light	2,4	3	3	4	6	120	55	80
Professional 4	Standard	3	3,5	3,5	6	8	240	60	82
Professional 6	Intensive	3,5	3,5	3,5	6	8	360	65	85
Special programmes									
Prolong - Difficult dirt, Proeco - Cycle at low temperature, Proplates - Cycle for dishes, Proactive 5 - Pots and utensils, Proactive 7 - Pots and utensils									
Self-cleaning programmes									
Proself - Self-cleaning, Proclean - Self-cleaning and emptying, Prodrain - Emptying									

Codes and prices

MODEL	CODE 50HZ	RINSE PUMP DRAINAGE PUMP DETERGENT DISP.	ENERGY RECOVERY (RC)	€
WLP-61	19111090	X		-
WLP-62	19111092	X		-
WLP-62 RC	19111094	X	X	-
WLP-63	19111095	X		-
WLP-63 RC	19111096	X	X	-
WLP-70	19111097	X		-
WLP-70 RC	19111098	X	X	-
WLP-130	19111099	X		-
WLP-130 RC	19111100	X	X	-

Accessories

CODE	DESCRIPTION	DIMENSIONS (MM)	€
Baskets			
19023165	Basket for WLP-61	500x600	-
19010251	Basket for WLP-62 and WLP-63	560x630	-
19010252	Basket for WLP-70	700x700	-
19011085	Basket for WLP-130	1.320x700	-
Other accessories			
19010253	Pastry bag holder	Ø 17	-
19010254	Frame for 8 shelves, max. depth: 40mm	500x500	-
19010255	Container for utensils	150x150	-

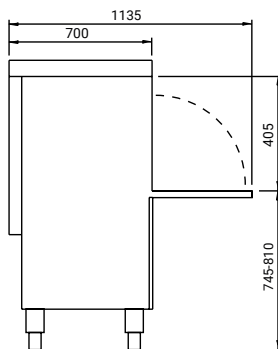

WLP-61

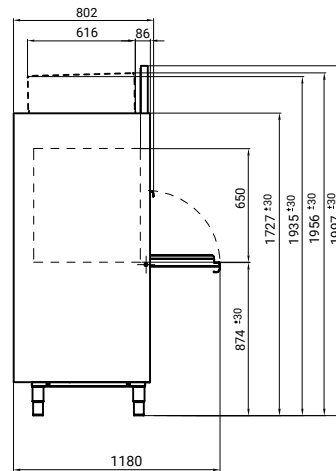

WLP-62 (RC)

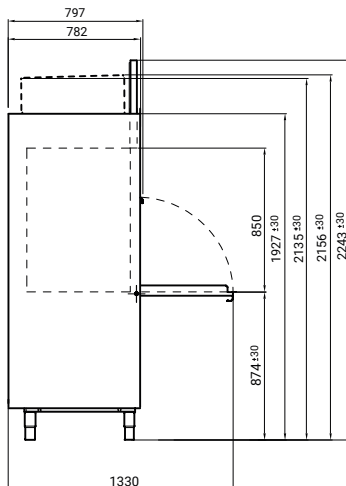

WLP-63 (RC)

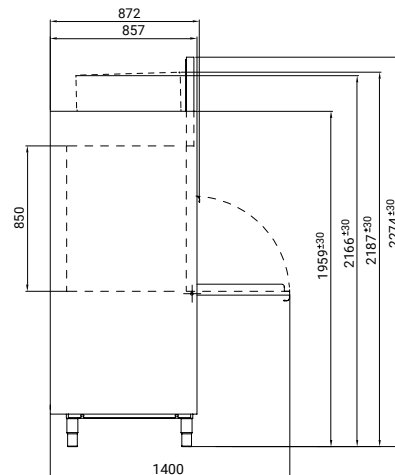

WLP-70 (RC) / WLP-130 (RC)



Robust and reliable machines, with an increased output capacity.

Rack conveyor

Compact dishwashers.....	215
Modular dishwashers.....	220
Accessories.....	226

CONCEPT

Rack conveyor | Compact dishwashers

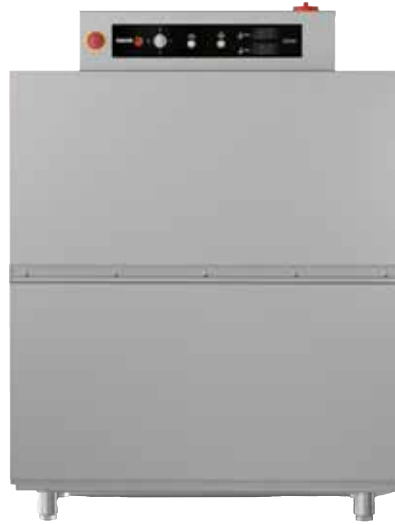

General characteristics

- All the main parts are manufactured in AISI-304 anti-corrosion stainless steel: tanks, washing and rinsing arms, rinsing jets, doors, basket conveyance system, boiler and metal tubes.
- Upwards-opening double panel door.
- Tank tray filters made of AISI-304 stainless steel, easy to access and remove for cleaning and access to the tank.
- Safety filter for pump suction.
- Rinsing boiler with heat insulation.
- Easy access for installation. Electrovalve located on one side (no need to remove panels to connect the machine).
- Electrical panel designed for easy connection of dosers for liquid and solid detergents, rinse aid, limit switches, supplementary emergency stop button.
- Washing arms easily removable as a set, for cleaning, with a plug on each branch providing access for cleaning inside.
- Rinse jets easily dismountable and removable.
- System of electronic regulation of speeds by means of frequency shifter.
- Configurable electronic temperature control:
 - Wash (50 - 65 °C)
 - Rinse (70 - 85 °C)
- Guarantor of rinse at 85 °C.
- Pressure regulator for flow control.
- Emergency stop button incorporated.
- Extra anti-entrapment protection system at the entrance, mounted on the AS-260 splash guard supplement (optional).
- Open door blocking system.
- IPX4 protection system.
- System for detection of blockage of conveyor carriage and automatic reverse function.
- High-power washing system with 4 upper and 4 lower washing branches.
- 3 washing programs: deep, medium and high-capacity.
- Double effect rinse.
- Energy-saving system: reduces consumption by halting operation of the pumps, and by passing the heating of the rinse to stand-by mode (70 °C).
- Auto-timer which deactivates the conveyor motor after a pre-set period of inactivity (10 minutes).
- Energy saving system in the wash: the wash does not start up until it detects the passage of the basket.
- Rinse saving system. The rinse stops when the basket has left, saving water and energy.
- Limit switch included.

Equipment included:

- 2 base baskets, CT-10
- 2 baskets for plates, CP-16/18
- 1 basket for glasses, CV-16/105
- 1 basket for cutlery, CT-10 R

MODEL	HZ	CODE	ENTRANCE (*)	WATER SUPPLY	PROGRAMS (BASKETS/H)			INTERNAL ZONES (**)	WATER CONSUMPTION (L/H)	ELECTRICAL POWER (kW)	DIMENSIONS (mm)	€
					DEEP	MEDIUM	HIGH-CAPACITY					
CCO-120-L-HW	50	19048203	L	>50°	80	100	120		210	19.45	1,180 x 790 x 1,550	-
	60	19048571										
CCO-120-R-HW	50	19048204	R	>50°	80	100	120	LP + A	210	19.45	1,180 x 790 x 1,550	-
	60	19048573										
CCO-120-L-CW	50	19045325	L	<50°	80	100	120		210	28.45	1,180 x 790 x 1,550	-
	60	19048217										
CCO-120-R-CW	50	19046527	R	<50°	80	100	120	LP + A	210	28.45	1,180 x 790 x 1,550	-
	60	19047158										

(*) Entry of baskets.
L: Entrance from the Left of the machine.
R: Entrance from the Right of the machine.

(**): Internal zones
■ LP: Main wash.
■ A: Double effect rinse.

CONCEPT

Rack conveyor | Compact dishwashers



General characteristics

- All the main parts are manufactured in AISI-304 anti-corrosion stainless steel: tanks, washing and rinsing arms, rinsing jets, doors, basket conveyance system, boiler and metal tubes.
- Upwards-opening double panel door.
- Tank tray filters made of AISI-304 stainless steel, easy to access and remove for cleaning and access to the tank.
- Safety filter for pump suction.
- Rinsing boiler with heat insulation.
- Easy access for installation. Electrovalve located on one side (no need to remove panels to connect the machine).
- Electrical panel designed for easy connection of dosers for liquid and solid detergents, rinse aid, limit switches, supplementary emergency stop button.
- Washing arms easily removable as a set, for cleaning, with a plug on each branch providing access for cleaning inside.
- Rinse jets easily dismantlable and

- removable.
- System of electronic regulation of speeds by means of frequency shifter.
- Configurable electronic temperature control:
 - Wash (50 - 65 °C)
 - Rinse (70 - 85 °C)
- Guarantor of rinse at 85 °C.
- Pressure regulator for flow control.
- Emergency stop button incorporated.
- Extra anti-entrapment protection system at the entrance, mounted on the AS-260 splash guard supplement (optional).
- Open door blocking system.
- IPX4 protection system.
- System for detection of blockage of conveyor carriage and automatic reverse function.
- High-power washing system with 4 upper and 4 lower washing branches.
- 3 washing programs: deep, medium and high-capacity.

- Double effect rinse.
- Energy-saving system: reduces consumption by halting operation of the pumps, and by passing the heating of the rinse to stand-by mode (70 °C).
- Auto-timer which deactivates the conveyor motor after a pre-set period of inactivity (10 minutes).
- Energy saving system in the wash: the wash does not start up until it detects the passage of the basket.
- Rinse saving system. The rinse stops when the basket has left, saving water and energy.
- Limit switch included.

Equipment included:

- 2 base baskets, CT-10
- 2 baskets for plates, CP-16/18
- 1 basket for glasses, CV-16/105
- 1 basket for cutlery, CT-10 R

MODEL	HZ	CODE	ENTRANCE (*)	WATER SUPPLY	PROGRAMS (BASKETS/H)			INTERNAL ZONES (**)	WATER CONSUMPTION (L/H)	ELECTRICAL POWER (kW)	DIMENSIONS (mm)	€
					DEEP	MEDIUM	HIGH-CAPACITY					
CCO-160-L-HW	50	19048233	L	>50°	100	130	160		240	22,45	1.180 x 790 x 1.550	-
	60	19048576										
CCO-160-R-HW	50	19048255	R	>50°	100	130	160	LP + A	240	22,45	1.180 x 790 x 1.550	-
	60	19048579										
CCO-160-L-CW	50	19048231	L	<50°	100	130	160		240	31,45	1.180 x 790 x 1.550	-
	60	19048575										
CCO-160-R-CW	50	19048254	R	<50°	100	130	160	LP + A	240	31,45	1.180 x 790 x 1.550	-
	60	19048578										

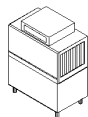

(*): Entry of baskets.
L: Entrance from the Left of the machine.
R: Entrance from the Right of the machine.

(**): Internal zones
LP: Main wash.
A: Double effect rinse.

CONCEPT

Rack conveyor | Compact dishwashers "eco" version - gas heated

CCO-160-L-ECO + AS-260 + GWB-40



General characteristics

- The ECO version conveyor dishwashers are fitted with an external hot water generator, gas heated, model GWB-40 (#).
- The generator replaces the electric rinse boiler in the dishwasher, bringing a significant saving in electricity consumption.
- Given the heating power of the generator, the dishwasher can be installed in facilities with a cold water connection.
- The dishwasher has a motor pump to send the water from the generator to the rinse jets.
- The dishwasher incorporates a flow regulator to ensure constant water consumption.
- The first filling of the dishwasher wash tank takes place with water from the generator, rapidly reaching the set temperature.

MODEL	HZ.	CODE (#)	ENTRANCE WATER (*) SUPPLY	PROGRAMS (BASKETS/H)			INTERNAL ZONES (**)	WATER CONSUMPTION (L/H)	ELECTRICAL POWER (kW)	GAS POWER (kW)	DIMENSIONS (mm)	€
				DEEP	MEDIUM	HIGH-CAPACITY						
	50	19046991	L	<50°	80	100		210	10,7	35	1.180 x 790 x 1.550	-
	60	19048572										
	50	19046990	R	<50°	80	100		210	10,7	35	1.180 x 790 x 1.550	-
	60	19048574										
	50	19048253	L	<50°	100	130		240	10,7	35	1.180 x 790 x 1.550	-
	60	19048577										
	50	19048256	R	<50°	100	130		240	10,7	35	1.180 x 790 x 1.550	-
	60	19048580										

(#) Note:
The generator is already included in the price of the dishwasher. When ordering, the GWB-40 generator code must be added to the machine code.

(*) Entrance of baskets.
L: Entrance from the Left of the machine.
R: Entrance from the Right of the machine.

(**): Internal zones
 LP: Main wash.
 A-ECO: Double effect rinse.

Gas hot water generator GWB-40

MODEL	HZ.	GAS	CODE	DESCRIPTION	POWER (kW)	DIMENSIONES (mm)	€
	GWB-40	LPG	19011596	GAS HOT WATER GENERATOR	35	432x548x770	-
		GN	19038585	Forced draught burner and double safety valve.			
		LPG	19044808	Electronic control of temperature and water levels.			
		GN	19044809	Automatic limescale removal. Automatic tank emptying.			

Complementary modules for compact rack conveyor dishwashers

AS-260



CRS-600





CDT-600



Factory assembly options on request

MODEL	HZ	CODE	DESCRIPTION	POWER (KW)	DIMENSIONS (mm)	€	
OPTION AT THE ENTRANCE TO SELECT FROM							
	AS-260	-	19048568	ANTI-SPLASH GUARD SUPPLEMENT (ENTER) With fitting for connection of fume extractor. With separator curtains. Includes extra anti-entrapment protection element. Fitted as standard at the entrance of modular dishwashers. This item cannot be installed on dishwashers fitted with energy recovery (CRS)	-	L = 260 mm	-
	CRS-600	50/60	19048639	CONVEYOR RECOVERY SYSTEM: Recommended for models with cold water input (CW) Aspires the steam generated inside the tunnel and sends the condensed water to the tank of the machine, increasing the water temperature from 15/18 °C to 35/40 °C . Allows savings of up to 3 kW-h. Recommended for models with cold water input (CW) with temperatures no higher than 25 °C. It is not appropriate for installation in machines with hot water input, nor in ECO models with rinse water heating in the GWB-40 generator. Module with conveyance system included. With separator curtains. Bottom shelf. This item cannot be installed on dishwashers fitted with anti-splash guard supplement at the entrance (AS-260).	0,75	600x790x1.930	-
OPTION AT THE EXIT TO SELECT FROM							
	CDT-600	50/60	19046516	DRYING TUNNEL : Supplementary element with 9 kW heating element box and upper fan for drying of the dishes with 0,55 kW motor. Module with conveyance system included, for placement at the end of the machine. With separator curtains. Bottom shelf. This item cannot be installed on dishwashers fitted with anti-splash guard supplement at the exit (ASE-260). A maximum of one drier per machine can be installed.	9,55	600x790x1.930	-
	ASE-260	-	19076633	ANTI-SPLASH GUARD SUPPLEMENT (EXIT) With fitting for connection of fume extractor. With separator curtains. Includes extra anti-entrapment protection element. Optional on all compact or modular rack-type dishwashers. This item cannot be installed on dishwashers fitted with CDT drying.	-	L = 260 mm	-

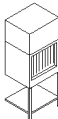
Dissassembled accesories

MODEL	HZ	CODE	DESCRIPTION	POWER (KW)	DIMENSIONS (mm)	€	
	KIT CDT-600 MODULE L	50/60	19056095	DRYING TUNNEL: Supplementary element with 9 kW heating element box and upper fan for drying of the dishes with 0,55 kW motor. Module with conveyance system included, for placement at the end of the machine. With separator curtains. Bottom shelf. A maximum of one drier per machine can be installed.	9,55	600x790x1.930	-
	KIT CDT-600 MODULE R	50/60	19086106				

Transformations to other voltages

VOLTAGE	CHARACTERISTICS	€
400- 440V 3~ (RC-C)	400- 440V 3~ connection for ships in Compact rack type dishwashers	-
220-240V 3~ (RC)	220-240V 3~ connection for rack type dishwashers	-

Packs for compact rack conveyor dishwashers



CCO-120 PACK L CW



	COMPOSITION		MODEL	CODE 50HZ
	Model	Code (1)		
Dishwasher	CCO-120 L CW	19045325		
Anti-salp.	AS-260	19048568	CCO-120 PACK L CW	19068300
Drying tunnel	CDT-600	19046516		
Dishwasher	CCO-120 R CW	19046527		
Anti-salp.	AS-260	19048568	CCO-120 PACK R CW	19068304
Drying tunnel	CDT-600	19046516		
Dishwasher	CCO-160 L CW	19048231		
Anti-salp.	AS-260	19048568	CCO-160 PACK L CW	19068305
Drying tunnel	CDT-600	19046516		
Dishwasher	CCO-160 R CW	19048254		
Anti-salp.	AS-260	19048568	CCO-160 PACK R CW	19068306
Drying tunnel	CDT-600	19046516		

MODEL	CODE (1)	ENTRANCE	HZ	PRODUCTION		WATER	POWER	DIMENSIONS	€
				Speed No.	Baskets/h				
CCO-120 PACK L CW	19068300	L	50	3	120	210	38,00	2.040x790x1.930	-
CCO-120 PACK R CW	19068304	R	50	3	120	210	38,00	2.040x790x1.930	-
CCO-160 PACK L CW	19068305	L	50	3	160	240	41,00	2.040x790x1.930	-
CCO-160 PACK R CW	19068306	R	50	3	160	240	41,00	2.040x790x1.930	-

(1): Machines not ready to assembly neither introducer of baskets in corner nor automatized curves for exit.

L: Entrance from the Left of the machine.

R: Entrance from the Right of the machine.

CONCEPT

Rack conveyor | Modular dishwashers

CCO-180-L



General characteristics

- All the main parts are manufactured in AISI-304 anti-corrosion stainless steel: tanks, washing and rinsing arms, rinsing jets, doors, basket conveyance system, boiler and metal tubes.
- Upwards-opening double panel door.
- Tank tray filters made of AISI-304 stainless steel, easy to access and remove for cleaning and access to the tank.
- Safety filter for pump suction.
- Rinsing boiler with heat insulation.
- Easy access for installation. Electrovalve located on one side (no need to remove panels to connect the machine).
- Electrical panel designed for easy connection of dosers for liquid and solid detergents, rinse aid, limit switches, supplementary emergency stop button.
- Washing arms easily removable as a set, for cleaning, with a plug on each branch providing access for cleaning inside.
- Rinse jets easily dismountable and removable.
- System of electronic regulation of speeds by means of frequency shifter.
- Configurable electronic temperature control:
 - Wash (50 - 65 °C)
 - Rinse (70 - 85 °C)
- Guarantor of rinse at 85 °C.
- Pressure regulator for flow control.
- Emergency stop button incorporated.
- Extra anti-entrapment protection system at the entrance, mounted on the AS-260 splash guard supplement, as standard.
- Open door blocking system.
- IPX4 protection system.
- System for detection of blockage of conveyor carriage and automatic reverse function.
- Prewash module with 3 upper and 3 lower washing branches.
- High-power washing system with 5 upper and 5 lower washing branches.
- 3 washing programs: intensive (DIN10534), medium and high-capacity.
- Pre-rinse and rinse, both double effect, in models 180, 225 and 270.
- Triple-effect pre-rinse and double-effect rinse in model 320.
- Energy-saving system: reduces consumption by halting operation of the pumps, and by passing the heating of the rinse to stand-by mode (70 °C).
- Auto-timer which deactivates the conveyor motor after a pre-set period of inactivity (10 minutes).
- Energy saving system in the wash: the wash does not start up until it detects the passage of the basket.
- Rinse saving system. The rinse stops which the basket has left, saving water and energy.
- Limit switch included.

Equipment included:

- 2 base baskets, CT-10
- 2 baskets for plates, CP-16/18
- 1 basket for glasses, CV-16/105
- 1 basket for cutlery, CT-10 R

MODEL	HZ	CODE	ENTRANCE	WATER SUPPLY	PROGRAMS (BASKETS/H)			MODULES COMPOSITION (**)	WATER CONSUMPTION (L/H)	ELECTRICAL POWER (KW)	DIMENSIONS (mm)	€
					INTENSIVE (DIN-10534)	MEDIUM	HIGH CAPACITY					
CCO-180-L-HW	50	19048582	L	>50°	90	135	180		210	25,7	1.750 x 790 x 1.550	-
	60	19048583										
CCO-180-R-HW	50	19048587	R	>50°	90	135	180		210	25,7	1.750 x 790 x 1.550	-
	60	19048588										
CCO-180-L-CW	50	19047209	L	<50°	90	135	180		210	34,7	1.750 x 790 x 1.550	-
	60	19048581										
CCO-180-R-CW	50	19047164	R	<50°	90	135	180		210	34,7	1.750 x 790 x 1.550	-
	60	19051473										
CCO-225-L-HW	50	19048595	L	>50°	125	175	225		210	35,9	2.360 x 790 x 1.550	-
	60	19048596										
CCO-225-R-HW	50	19048212	R	>50°	125	175	225		210	35,9	2.360 x 790 x 1.550	-
	60	19048600										
CCO-225-L-CW	50	19048119	L	<50°	125	175	225		210	44,9	2.360 x 790 x 1.550	-
	60	19048594										
CCO-225-R-CW	50	19048120	R	<50°	125	175	225		210	44,9	2.360 x 790 x 1.550	-
	60	19048599										

(*) Entry of baskets:

L: Entrance from the Left of the machine.

R: Entrance from the Right of the machine.

(**) COMPOSITION OF MODULES

The diagrams and composition indicated always refer to the left-entry version.

AS-260: Anti-splash guard supplement

PL3: Cold water prewash

PL5: First Wash with cold water

L5: First wash with hot water

LP: Main wash

DA: Double-effect rinse and pre-rinse

TA: Double-effect rinse and triple-effect pre-rinse

CONCEPT

Rack conveyor | Modular dishwashers

CCO-320-L



General Characteristics

- All the main parts are manufactured in AISI-304 anti-corrosion stainless steel: tanks, washing and rinsing arms, rinsing jets, doors, basket conveyance system, boiler and metal tubes.
- Upwards-opening double panel door.
- Tank tray filters made of AISI-304 stainless steel, easy to access and remove for cleaning and access to the tank.
- Safety filter for pump suction.
- Rinsing boiler with heat insulation.
- Easy access for installation. Electrovalve located on one side (no need to remove panels to connect the machine).
- Electrical panel designed for easy connection of dosers for liquid and solid detergents, rinse aid, limit switches, supplementary emergency stop button.
- Washing arms easily removable as a set, for cleaning, with a plug on each branch providing access for cleaning inside.
- Rinse jets easily dismantlable and removable.
- System of electronic regulation of speeds by means of frequency shifter.
- Configurable electronic temperature control:
 - Wash (50 - 65 °C)
 - Rinse (70 - 85 °C)
- Guarantor of rinse at 85 °C.
- Pressure regulator for flow control.
- Emergency stop button incorporated.
- Extra anti-entrapment protection system at the entrance, mounted on the AS-260 splash guard supplement, as standard.
- Open door blocking system.
- IPX4 protection system.
- System for detection of blockage of conveyor carriage and automatic reverse function.
- Prewash module with 3 upper and 3 lower washing branches.
- High-power washing system with 5 upper and 5 lower washing branches.
- 3 washing programs: intensive (DIN10534), medium and high-capacity.
- Pre-rinse and rinse, both double effect, in models 180, 225 and 270.
- Triple-effect pre-rinse and double-effect rinse in model 320.
- Energy-saving system: reduces consumption by halting operation of the pumps, and by passing the heating of the rinse to stand-by mode (70 °C).
- Auto-timer which deactivates the conveyor motor after a pre-set period of inactivity (10 minutes).
- Energy saving system in the wash: the wash does not start up until it detects the passage of the basket.
- Rinse saving system. The rinse stops which the basket has left, saving water and energy.
- Limit switch included.

Equipment included:

- 2 base baskets, CT-10
- 2 baskets for plates, CP-16/18,
- 1 basket for glasses, CV-16/105,
- 1 basket for cutlery, CT-10 R

MODEL	HZ	CODE	ENTRANCE (*)	PROGRAMS (BASKETS/H)			MODULES COMPOSITION (**)	WATER CONSUMPTION (L/H)	ELECTRICAL POWER (KW)	DIMENSIONS (mm)	€
				SUPPLY	INTENSIVE (DIN-10534)	MEDIUM					
CCO-270-L-HW	50	19048608	L	>50°	140	205	AS-260 + PL5+LP +DA	240	39,9	2.660 x 790 x 1.550	-
	60	19048609	R								
CCO-270-R-HW	50	19048614	R	<50°	140	205	AS-260 + PL5+LP +DA	240	48,9	2.660 x 790 x 1.550	-
	60	19048615	L								
CCO-270-L-CW	50	19048606	L	<50°	140	205	AS-260 + PL3+L5+LP +DA	240	48,9	2.660 x 790 x 1.550	-
	60	19048607	R								
CCO-270-R-CW	50	19048612	R	<50°	140	205	AS-260 + PL3+L5+LP +DA	240	48,9	2.660 x 790 x 1.550	-
	60	19048613	L								
CCO-320-L-HW	50	19048621	L	>50°	170	245	AS-260 + PL3+L5+LP+TA	240	47,1	3.260 x 790 x 1.550	-
	60	19048622	R								
CCO-320-R-HW	50	19048630	R	<50°	170	245	AS-260 + PL3+L5+LP+TA	240	56,1	3.260 x 790 x 1.550	-
	60	19048631	L								
CCO-320-L-CW	50	19048618	L	<50°	170	245	AS-260 + PL3+L5+LP+TA	240	56,1	3.260 x 790 x 1.550	-
	60	19048620	R								
CCO-320-R-CW	50	19048627	R	<50°	170	245	AS-260 + PL3+L5+LP+TA	240	56,1	3.260 x 790 x 1.550	-
	60	19048628	L								

(*) Entry of baskets:

- L: Entrance from the Left of the machine.
- R: Entrance from the Right of the machine.

(**) Composition of modules

The diagrams and composition indicated always refer to the left-entry version.

- AS-260: Anti-splash guard supplement
- PL3: Cold water prewash
- PL5: First Wash with cold water
- L5: First wash with hot water
- LP: Main wash
- DA: Double-effect pre-rinse and rinse
- TA: Triple-effect pre-rinse and double-effect rinse

CONCEPT

Rack conveyor | Modular dishwashers "ECO" version - gas heated

CCO-225-L-ECO + GWB-40



Specific characteristics

- The ECO version conveyor dishwashers are fitted with an external hot water generator, gas heated, model GWB-40 (#).
- The generator replaces the electric rinse boiler in the dishwasher, bringing a significant saving in electricity consumption.
- Given the heating power of the generator, the dishwasher is for installation in facilities with a cold water connection.
- The dishwasher has a motor pump to send the water from the generator to the rinse jets.
- The dishwasher incorporates a flow regulator to ensure constant water consumption.
- The first filling of the dishwasher wash tank takes place with water both from the generator and from the filling electrovalve.

MODEL	HZ	CODE	ENTRANCE WATER (*)	PROGRAMS (BASKETS/H)			MODULES COMPOSITION (**)	WATER CONSUMPTION (L/H)	ELECTRICAL POWER (KW)	GAS POWER (KW)	DIMENSIONS (mm)	€
				SUPPLY	INTENSIVE (DIN-10534)	MEDIUM						
CCO-180-L-ECO	50	19048584	L	<50°	90	135	AS-260 + LP + DA-ECO GWB-40	210	19,7	35	1.750 x 790 x 1.550	-
60	19048586											
CCO-180-R-ECO	50	19048591	R	<50°	125	175	AS-260+PL3+LP+DA-ECO GWB-40	210	20,9	35	2.360 x 790 x 1.550	-
60	19048593											
CCO-225-L-ECO	50	19048597	L	<50°	140	205	AS-260 + PL5+LP+DA-ECO GWB-40	240	21,9	35	2.660 x 790 x 1.550	-
60	19048598											
CCO-225-R-ECO	50	19048602	R	<50°	170	245	AS-260 + PL3+L5+LP+TA-ECO GWB-40	240	29,1	35	3.260 x 790 x 1.550	-
60	19048603											
CCO-270-L-ECO	50	19048610	L	<50°	170	245	AS-260 + PL3+L5+LP+TA-ECO GWB-40	240	29,1	35	3.260 x 790 x 1.550	-
60	19048611											
CCO-270-R-ECO	50	19048616	R	<50°	170	245	AS-260 + PL3+L5+LP+TA-ECO GWB-40	240	29,1	35	3.260 x 790 x 1.550	-
60	19048617											
CCO-320-L-ECO	50	19048624	L	<50°	170	245	AS-260 + PL3+L5+LP+TA-ECO GWB-40	240	29,1	35	3.260 x 790 x 1.550	-
60	19048626											
CCO-320-R-ECO	50	19048633	R	<50°	170	245	AS-260 + PL3+L5+LP+TA-ECO GWB-40	240	29,1	35	3.260 x 790 x 1.550	-
60	19048636											

(#) Note on codes

The generator is already included in the price of the dishwasher. When ordering, the GWB-40 generator code must be added to the machine code.

(*) Entry of baskets:

L: Entrance from the Left of the machine.
R: Entrance from the Right of the machine.

(**) COMPOSITION OF MODULES

The diagrams and composition indicated always refer to the left-entry version.

- AS-260: Anti-splash guard supplement
- PL3: Cold water prewash
- PL5: First Wash with cold water
- L5: First wash with hot water
- LP: Main wash
- DA: Double-effect rinse and pre-rinse
- TA: Double-effect rinse and triple-effect pre-rinse

Gas hot water generator GWB-40

MODEL	HZ	GAS	CODE	DESCRIPTION	POWER (KW)	DIMENSIONES (mm)	€
GWB-40	50	LPG	19011596	GAS HOT WATER GENERATOR Forced draught burner and double safety valve. Electronic control of temperature and water levels. Automatic limescale removal. Automatic tank emptying.	35	432x548x770	-
		GN	19038585				
	60	LPG	19044808				
		GN	19044809				

Complementary modules for modular rack conveyor dishwashers

CRS-700 L





CDT-600



ASE-260



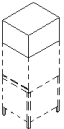
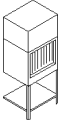
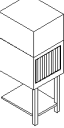





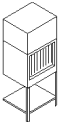

Factory assembly options on request

MODEL	HZ	CODE	DESCRIPTION	POWER (kW)	DIMENSIONS (mm)	€
OPTION AT THE ENTRANCE						
	(*) CRS-700-L CRS-700-R	50/60 19056031 19048641	UPPER ENERGY RECOVERY Recommended for dishwashers with cold water inlet (CW) with temperatures not exceeding 25 °C. It aspirates the steam generated inside the tunnel and sends the condensed water to the tanks of the machine, increasing the water temperature from 15/18 °C to 35/40 °C. Save up to 3 kW-h. Fitted into the top of the dishwasher. Does not increase length. Its installation does not proceed in machines with hot water inlet, nor in ECO models with rinse water heating in the GWB-40 generator.	0,55	600x790x500	-
OPTION AT THE EXIT TO SELECT FROM						
	CDT-600	50/60 19046516	SHORT DRYING TUNNEL FOR MODELS 180 AND 225 Supplementary element with 9 kW heating element box and upper fan for drying of the dishes with 0.55 kW motor. Module with conveyance system included, for placement at the end of the machine. With separator curtains. Bottom shelf. This element cannot be installed in a dishwasher equipped with exist anti-splash guard supplement (ASE-260). A maximum of one drier per machine can be installed.	9,55	600x790x1.930	-
	CDT-800	50/60 19047215	LONG DRYING TUNNEL FOR MODELS 270 AND 320 Supplementary element with 13,5 kW heating element box and upper fan for drying of the dishes with 1,1 kW motor. Module with conveyance system included, for placement at the end of the machine. With separator curtains. Bottom shelf. A maximum of one drier per machine can be installed. This element cannot be installed in a dishwasher equipped with exist anti-splash guard supplement (ASE-260).	14,6	800x790x1.930	-
	ASE-260	- 19076633	ANTI-SPLASH GUARD SUPPLEMENT (EXIT) With fitting for connection of fume extractor. With separator curtains. Includes extra anti-entrapment protection element. Optional on all compact or modular rack-type dishwashers. This item cannot be installed on dishwashers fitted with CDT drying.	-	L = 260 mm	-

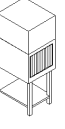
(*) Entry of baskets: L: Entrance from the Left of the machine. R: Entrance from the Right of the machine.

Dissassembled accesories

MODEL	HZ	CODE	DESCRIPTION	POWER (kW)	DIMENSIONS (mm)	€
	KIT CDT-600 MODULE L	50/60  19056095	SHORT DRYING TUNNEL FOR MODELS 180 AND 225 Supplementary element with 9 kW heating element box and upper fan for drying of the dishes with 0.55 kW motor. Module with conveyance system included, for placement at the end of the machine. With separator curtains. Bottom shelf. This element cannot be installed in a dishwasher equipped with exist anti-splash guard supplement (ASE-260). A maximum of one drier per machine can be installed.	9,55	600x790x1.930	-
	KIT CDT-600 MODULE R	50/60  19086106				
	KIT CDT-800 MODULE L	50/60  19056098	LONG DRYING TUNNEL FOR MODELS 270 AND 320: Supplementary element with 13,5 kW heating element box and upper fan for drying of the dishes with 1,1 kW motor. Module with conveyance system included, for placement at the end of the machine. With separator curtains. Bottom shelf. This element cannot be installed in a dishwasher equipped with exist anti-splash guard supplement (ASE-260). A maximum of one drier per machine can be installed.	14,6	800x790x1.930	-
	KIT CDT-800 MODULE R	50/60  19086108				

Transformations to other voltages

VOLTAGE	CHARACTERISTICS	€
400- 440V 3~ (RC-M)	400- 440V 3~ connection for ships in Modular rack type dishwashers	-
220-240V 3~ (RC)	220-240V 3~ connection for rack type dishwashers	-



Overview of the characteristics of the different modules

Table of modules that can form part of the composition of modular traction units.

The composition of the different models is shown on the previous pages.

MÓDULO		COMPACT		MODULAR			
		CCO-120	CCO-160	CCO-180	CCO-225	CCO-270	CCO-320
Supplementary Anti-splash + anti-entrapment protection at the entrance	AS-260	•	•	•	•	•	•
Prewash	PL3	-	-	-	•	-	•
Intense prewash	PL5	-	-	-	-	•	-
First wash	L5	-	-	-	-	-	•
Main wash	LP	•	•	•	•	•	•
Double effect rinse	A	•	•	-	-	-	-
Double effect ECO rinse	A-ECO	•	•	-	-	-	-
Double effect pre-rinse + Double effect rinse	DA	-	-	•	•	•	-
Double effect pre-rinse + Double effect ECO rinse	DA-ECO	-	-	•	•	•	-
Triple effect pre-rinse + Double effect rinse	TA	-	-	-	-	-	•
Triple effect pre-rinse + Double effect ECO rinse	DA / TA-ECO	-	-	-	-	-	•
Drying Module 600	CDT-600	•	•	•	•	-	-
Drying Module 800	CDT-800	-	-	-	-	•	•
Energy recycler for compact models	CRS-600	•	•	-	-	-	-
Energy recycler for modular dishwashers	CRS-700	-	-	•	•	•	•
Supplementary anti-splash guard at the exit	ASE-260	•	•	•	•	•	•

•: Standard •: Optional

All the modular machines come with an anti-splash module AS-260 at the entrance as standard, 260 mm in length. An exterior extractor can be fitted to this module. Optionally, you can also request it as a supplement to fit to the exit of the machine.

The CDT drying tunnels are fitted to the exit of the machine, increasing the total length by 600 or 800 mm (depending on the model of drying tunnel installed). For models 270 and 320, the long CDT-800 drying tunnel is to be installed.

The CRS-700 energy recycler is to be placed on top of the modular dishwashers, and the total length is not increased. Recommended for models with cold water input (CW) with temperatures no higher than 25 °C. It is not appropriate for installation in machines with hot water input, nor in ECO models with rinse water heating in the GWB-40 generator.

The mission of this accessory is to collect the steam from the inside of the dishwasher, and, after a process of condensation, send this water (which is at high temperature) to the rinse system. This raises the average temperature in the rinse system, which therefore requires a lower supply of electrical energy, contributing to notable savings in energy and costs (around 3 kW-h).

Summary table of characteristics for conveyor dishwashers

	CCO-120	CCO-160	CCO-180	CCO-225	CCO-270	CCO-320
Speeds	3	3	3	3	3	3
Production (baskets/h)						
Deep wash program	80	100	-	-	-	-
Intensive program (DIN-10534)	-	-	90	125	140	170
Medium program	100	130	135	175	225	245
High-capacity program	120	160	180	225	270	320
PREWASH PL3,PL5						
Tank capacity (l)	-	-	-	60	100	60
Pump power (kW)	-	-	-	1,2	2,2	1,2
WASH L5, LP						
Tank capacity (l)	50	50	100	100	100	200
Temperature (°C)	55-65	55-65	55-65	55-65	55-65	55-65
Heating power (kW)	9	9	12	12	12	18
Pump power (kW)	1,2	1,2	2,2	2,2	2,2	4,4
PRE-RINSE DA, TA						
Tank capacity (l)	-	-	15	15	15	15
Temperature (°C)	-	-	70	70	70	70
Heating power (kW)	-	-	5	5	5	5
Pump power (kW)	-	-	0,26	0,26	0,26	0,26
RINSE						
Boiler volume (l)	21	21	21	21	21	21
Temperature (°C)	80-85	80-85	80-85	80-85	80-85	80-85
Heating power (kW)						
CW	27	30	27	24	27	27
CW with recycler	24	27	24	21	24	24
HW	18	21	18	15	18	18
ECO	-	-	-	-	-	-
ECO rinse pump power (kW)	0,26	0,26	0,26	0,26	0,26	0,26
Water consumption *1						
(l/h)	210	240	210	210	240	240
(l/basket)	1,75	1,5	1,17	0,93	0,89	0,75
STANDARD CONNECTION						
Type of connection (default)	ALT.	ALT.	ALT.	SIM.	SIM.	SIM.
Voltage *2	400 V /3N ~ / 50 - 60Hz					
Total power (kW)						
CW	28,5	31,5	34,7	44,9	48,9	56,1
CW with recycler	26,2	29,2	32,3	42,5	46,5	53,7
HW	19,5	22,5	25,7	35,9	39,9	47,1
ECO	10,7	10,7	19,7	20,9	21,9	29,1
ECO gas booster (gas kW)	35	35	35	35	35	35
WIDTH (mm)						
Standard	1.180	1.180	1.750	2.360	2.660	3.260
With drying module	1.780	1.780	2.360	2.360	3.460	4.060
Depth (mm)	790	790	790	790	790	790
HEIGHT (mm) *3						
Standard	1.550-1.610	1.550-1.610	1.550-1.610	1.550-1.610	1.550-1.610	1.550-1.610
With drying	1.860-1.920	1.860-1.920	1.860-1.920	1.860-1.920	1.860-1.920	1.860-1.920
With recycler	1.960-2.020	1.960-2.020	1.960-2.020	1.960-2.020	1.960-2.020	1.960-2.020
With open door blocking system	1.870-1.930	1.870-1.930	1.870-1.930	1.870-1.930	1.870-1.930	1.870-1.930
Operating height (mm)	850-900	850-900	850-900	850-900	850-900	850-900
Useful entrance height (mm)	390	390	390	390	390	390
Passage width (mm)	510	510	510	510	510	510
WEIGHT (KG)						
Net	211	211	259	381	434	556
Gross	305	305	382	556	628	792
WATER CONNECTION						
Operating pressure	2 - 4 bars					
Type of connection	3/4" GAS					
T ^a of hot water	50 °C - 60 °C					
T ^a of cold water	15 °C - 50 °C					

*1- Non-binding information Consumption might vary depending on the characteristics of the facility

*2- Standard voltage: 400 V 3+N - For other voltages and options, please consult Fagor Professional

*3- The adjustable feet allow for height adjustment, raising the machine by up to 60 mm

Pre-rinsing tables

MFDB-1200 LM-R



General characteristics

- Manufactured for the compact and modular conveyor dishwashers.

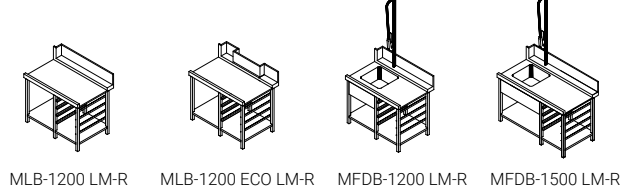

MODEL	CODE	ENTRY (*)	EQUIPMENT FEATURES	DIMENSIONS (mm)	€
MLB-1200 LM-R	19006097	R	- Rear guard - Lower rack - Guides for baskets	1.200x800x900	-
MLB-1200 LM-L	19006096	L			
MLB-1200 ECO/LM-R	19006099	R	- Rear guard - Lower rack - Guides for baskets	1.200x800x900	-
MLB-1200 ECO/LM-L	19006098	L	- Hole for chimney of GWB-40		
MFDB-1200 LM-R	19006104	R	- Rear guard - Sink - Shower tap - Lower rack - Guides for baskets	1.200x800x900	-
MFDB-1200 LM-L	19006105	L			
MFDB-1500 LM-R	19006404	R	- Rear guard - Sink - Shower tap - Lower rack - Guides for baskets	1.500x800x900	-
MFDB-1500 LM-L	19006405	L			



(*) Entrance of the baskets:
L: Entry from the left side of the machine.
R: Entrance from the right side of the machine.

Delivery / sorting tables



General characteristics

- Serving staff can deposit dirty dishes while the dishwashing staff are sorting them on the other side.
- The table is supplied with a sorting shelf (450 mm over the work top) and a waste disposal.
- Adjustable feet.

MODEL	CODE	SHELF DIMENSIONS (mm)	SHELF CAPACITY (BASKETS)	DIMENSIONS (mm)	€
MD3C	19006410	1.530x600	3	1.600x800x1.642	-
MD4C	19006509	2.030x600	4	2.100x800x1.642	-

Delivery / sorting tables

MFDP-1800 LM-L



General characteristics

- Manufactured for the compact and modular conveyor dishwashers:
- Rear guard in all the models.
- Waste disposal.
- Space for the trash bin.
- Tables with sink built-in shower tap.

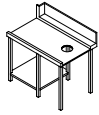

MLH-1200 LM-R

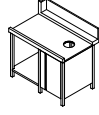

MLP-1200 LM-R

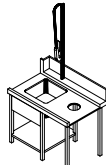

MFDH-1200 LM-R

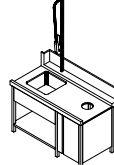

MFDP-1500 LM-R

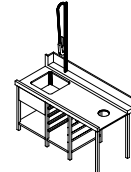

MFDH-1800 LM-R

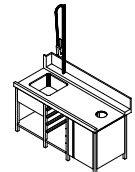

MFDP-1800 LM-R

MODEL	CODE	ENTRY (*)	HOUSING FOR BIN	CHARACTERISTICS	DIMENSIONS (mm)	€
MLH-1200 LM-R	19006100	R	OPEN	- Lower rack	1.200x800x900	-
MLH-1200 LM-L	19006101	L				
MLP-1200 LM-R	19006102	R	DOOR	- Lower rack	1.200x800x900	-
MLP-1200 LM-L	19006103	L				
MFDH-1200 LM-R	19006106	R	OPEN	- Sink - Shower tap - Lower rack	1.200x800x900	-
MFDH-1200 LM-L	19006107	L				
MFDP-1200 LM-R	19006108	R	DOOR	- Sink - Shower tap - Lower rack	1.200x800x900	-
MFDP-1200 LM-L	19006109	L				
MFDH-1500 LM-R	19006408	R	OPEN	- Sink - Shower tap - Lower rack	1.500x800x900	-
MFDH-1500 LM-L	19006407	L				
MFDP-1500 LM-R	19006409	R	DOOR	- Sink - Shower tap - Lower rack	1.500x800x900	-
MFDP-1500 LM-L	19006406	L				
MFDH-1800 LM-R	19006506	R	OPEN	- Sink - Shower tap - Lower rack - Guides for baskets	1.800x800x900	-
MFDH-1800 LM-L	19006507	L				
MFDP-1800 LM-R	19006508	R	DOOR	- Sink - Shower tap - Lower rack - Guides for baskets	1.800x800x900	-
MFDP-1800 LM-L	19006505	L				

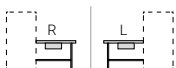

(*) Entrance of the baskets:
L: Entry from the left side of the machine.
R: Entrance from the right side of the machine.

Pre-rinsing table with introducer of baskets in corner

MCFD-1000 R

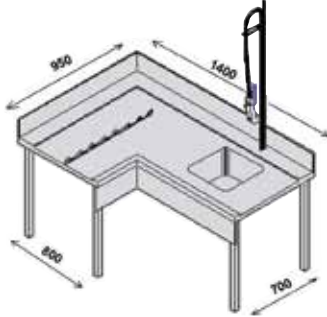

General characteristics

- Rear guard 200 mm. Built in sink and shower tap.
- Length of the sink side: 1,400 mm - Depth: 700 mm.
- Element to introduce the baskets with the movement of the advancement system of the conveyor.
- Length of the introducer side: 950 mm - Depth: 800 mm.
- Ask the manufacturer to adapt the machine to install the table.

MODEL	CODE	ENTRY (*)	EQUIPMENT FEATURES	DIMENSIONS (mm)	€
MCFD-1000 R	19006350	R	- Rear guard - Sink - Shower tap - Introducer	1.400x950x900	-
MCFD-1000 L	19006351	L			

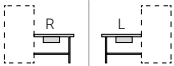

(*) Entrance of the baskets:
L: Entry from the left side of the machine.
R: Entrance from the right side of the machine.

Introducers of baskets in corner

E-90-R-CV

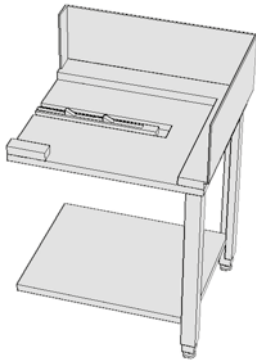

General characteristics

- Element to introduce the baskets in the machine.
- Movement by the advancement system of the conveyor.
- Rear guard 250 mm.
- Lower shelf.
- Ask the manufacturer to adapt the machine to install the introducer.



(*) Entrance of the baskets:
L: Entry from the left side of the machine.
R: Entrance from the right side of the machine.

MODEL	CODE	DESCRIPTION	DIMENSIONS (mm)	€
E-90-L	19004789	INTRODUCER OF BASKETS BY THE LEFT SIDE For rack conveyors WITH entry splash-guard (AS-260).	800x700x850	-
E-90-L-CV	19004792	INTRODUCER OF BASKETS BY THE LEFT SIDE For rack conveyors WITHOUT entry splash-guard (AS-260).	800x700x850	-
E-90-R	19004790	INTRODUCER OF BASKETS BY THE RIGHT SIDE For rack conveyors WITH entry splash-guard (AS-260).	800x700x850	-
E-90-R-CV	19004791	INTRODUCER OF BASKETS BY THE RIGHT SIDE For rack conveyors WITHOUT entry splash-guard (AS-260).	800x700x850	-
-	19003534	Basket introducer mechanism to install on a custom made introducer	-	-

Automatized curves for exit

180-L-TS



General characteristics

- Automatic movement with the conveyor exit system.
- Ask the manufacturer to adapt the machine to install the automatized curve.

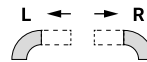

(*) Exit of basket. It is opposite to the model of conveyor dishwasher.
L: Exist from the left of the machine
R: Exist from the right of the machine

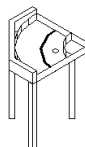
MODEL	CODE	EXIT (*)	DESCRIPTION	DIMENSIONS (mm)	€	
180-L-TS	19004788	L	AUTOMATIZED CURVE 180° AT LEFT For rack conveyors WITHOUT exit splash-guard (ASE-260). Also for models WITH DRYING TUNNEL	778x1.442x900	-	
	180-L	L	AUTOMATIZED CURVE 180° AT LEFT For rack conveyors WITH exit splash-guard (ASE-260).	778x1.442x900	-	
	180-R-TS	19004797	R	AUTOMATIZED CURVE 180° AT RIGHT For rack conveyors WITHOUT exit splash-guard (ASE-260). Also for models WITH DRYING TUNNEL	778x1.442x900	-
180-R	19004787	R	AUTOMATIZED CURVE 180° AT RIGHT For rack conveyors WITH exit splash-guard (ASE-260).	778x1.442x900	-	
	90-L-TS	L	AUTOMATIZED CURVE 90° AT LEFT For rack conveyors WITHOUT exit splash-guard (ASE-260). Also for models WITH DRYING TUNNEL	778x778x900	-	
	90-L	19004794	L	AUTOMATIZED CURVE 90° AT LEFT For rack conveyors WITH exit splash-guard (ASE-260).	778x778x900	-
	90-R-TS	19004796	R	AUTOMATIZED CURVE 90° AT RIGHT For rack conveyors WITHOUT exit splash-guard (ASE-260). Also for models WITH DRYING TUNNEL	778x778x900	-
	90-R	19004793	R	AUTOMATIZED CURVE 90° AT RIGHT For rack conveyors WITH exit splash-guard (ASE-260).	778x778x900	-

Rolling tables



General characteristics

- Removable rolling units made in ABS, Ø 40 mm.
- Easy cleaning.
- Drain outlet.
- Adjustable stainless steel legs.
- Can be connected to the automatic curves.
- Includes limit switch for connection to the dishwasher

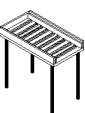
MODEL	CODE	DESCRIPTION	CAPACITY (BASKETS)	DIMENSIONS (mm)	€
	MR2C	Rolling table	2	1.128x665x850	-
	MR3C	Rolling table	3	1.638x665x850	-
	MR4C	Rolling table	4	2.148x665x850	-

Dishwashing





A high performance
solution.

Flight type dishwashers

Flight type dishwashers..... **231**

Common features of the range



- Wash modules without inner piping.
- Double-skin construction.
- Double-skin doors with thermal and acoustic insulation.
- Counterweighted doors with safety stops allow full unrestricted access to the pre-wash, wash, pre-rinse and rinse areas.
- Modular construction allowing the machine to be divided on site into narrower modules.
- Useful loading area of 763 mm and unloading area of 830 mm at 900 mm height.
- 150 mm splash (AS) guard module at the loading area.
- Activation of the washing process by photocell.
- Belt drive speed controlled by a frequency converter and a micro cut-off which, in the event of any kind of blockage, stops the machine without causing any damage to it. It has an unblocking feature that reverses the belt to help clear the jam.
- Autotimer: after a period of inactivity, the traction motor is deactivated, reducing power consumption.
- Power-saving mode (stand-by): Reduction of power consumption and limescale deposition on the heating element by reducing the temperature of the boiler and tank water when the machine is not in operation.
- Automatic pre-heating system. Activation of the washing pumps and the dryers prior to reaching the setpoint temperatures to heat the environment and thus achieve a quick start-up of the machine.
- Washing tanks:
 - 100-litre tank.
 - Washing system consisting of 6 upper arms and 5 lower arms.
- Stainless steel arms in the pre-wash and wash, removable for cleaning.
- Triple level filtration in the wash and pre-wash modules.
- The bottom of the tank is stamped to ensure complete draining and facilitate cleaning.
- Thermally insulated boilers.
- Easily removable stainless steel rinsing arms with high efficiency rinsing nozzles.
- Adjustable steam suction system that prevents vapours from escaping.
- Energy recovery included, located on the upper part of the machine, which allows the installed power to be reduced by 9kW.
- Drying (D) placed on the unloading area and possibility of adding up to 2 additional dryers (except in FCO-P3W4-RDD where only one can be added).
- Curtains resistant to high temperatures and detergents, which are installed to prevent water splashing and contamination between modules.
- Detection of belt end with stop and autostart.
- Machine protected against water jets according to IPX5 category.

Interface



- Electromechanical switch that allows you to choose between 3 programmes depending on the workload or dirt.
- Two digital displays for the control and visualisation of washing and rinsing temperatures.
- Unlock push button to reverse the conveyor carriage to help clear the jam and another push button to activate it.

- The conveyor carriage locking and activation push buttons are also on the loading and unloading areas.
- Emergency push buttons at the entrance and exit included.
- Main switch included.

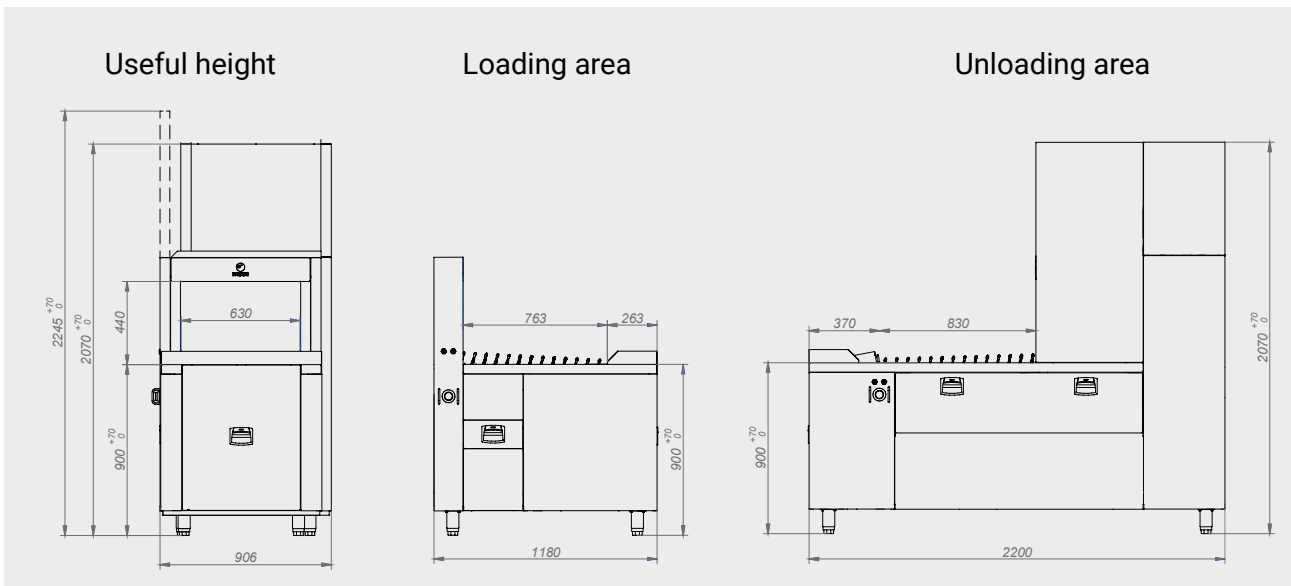

Available belts

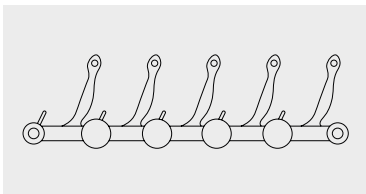

Belt for plates and baskets

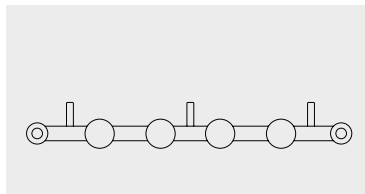

Belt for kitchenware (pots and containers)

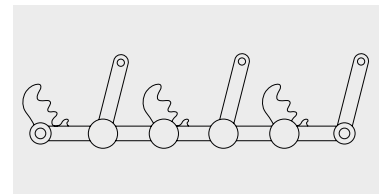

Belt for isothermal trays

CONCEPT

Flight type diswashers FCO-W4-RD

FCO-W4-RD R

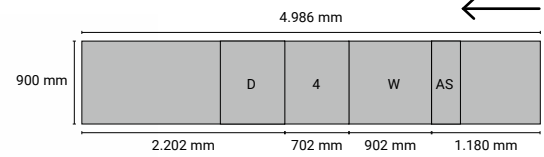

Specific features

- Electromechanical switch that allows you to choose between 3 programmes and two digital displays for the control and visualisation of washing and rinsing temperatures.
- Splash guard module (AS).
- Main wash (W).
- Prerinse / Rinse (4)
 - Pre-rinsing: Consisting of 2 upper and 1 lower prerinsing arms.
 - Rinsing: With one rinse pump. Type A non-return device in compliance with EN 1717. Consisting of 1 upper and 1 lower rinse arm. It uses a frequency converter for the rinse pump, which allows to vary the amount of rinse water by automatically adapting it to the selected conveying speed.
- Energy Recovery as standard (R).
- One standard drier (D) for optimal drying of ceramic dishes. Possibility of adding two extra dryers for drying plastic or stainless steel kitchenware

Technical data

Height (1)	mm	2.070
Height with door open	mm	2.200
Clearance (WxH)	mm	630x440
Supply water pressure min. - max.	bar	1,5-4
Traction motor	kW	0,25
WASH		
MAIN WASH W		
Tank capacity	lt	100
Tank power	kW	18
Washing pump power	kW	2,6
PRE-RINSE/RINSE		
		PRE-RINSE
		RINSE 4
Boiler capacity	lt	-
Tank capacity	lt	30
Boiler heater power	kW	-
Tank resistance power	kW	5
Prerinsing/rinsing pump power	kW	0,26
DRY		
		DRY D
Heater power	kW	7,5
Fan power	kW	1,95

(1) Adjustable height (+70/+0 mm)

Programs

PROGRAM	PRODUCTION (PLATES/H)	WATER CONSUMPTION (L/H)	WASH TEMPERATURE (°C)	RINSE TEMPERATURE (°C)	TOTAL POWER (KW)
					COLD WATER INLET WITH ENERGY RECOVERY (RC) 15°-25°
380-400V 3N Simultaneous					
Intensive program (DIN-10534)	1.575	190	65	85	53,8
Medium program	2.325	210	65	85	53,8
High capacity program	3.100	230	65	85	53,8

Codes and prices *

MODEL	CODE	HZ	ENTRY DIRECTION	€
FCO-W4-RD R	19073687	50	Right	-
	19108467	60		
FCO-W4-RD L	19075203	50	Left	-
	19077932	60		

* The price of the machine does not include the belt, which must be ordered separately.

Belts

CODE	MODEL	DESCRIPTION	€
19072468	PLATE BELT FCO-W4-RD	Belt for plates and baskets	-
19072498	KITCHENWARE BELT FCO-W4-RD	Belt for kitchenware (pots and containers)	-
19072497	ISOTHERMAL TRAY BELT FCO-W4-RD	Belt for isothermal trays	-

Extra drying

CODE	MODEL	VOLTAGE AND FREQUENCY (HZ)	DESCRIPTION	POWER (KW)	DIMENSIONS (MM)	€
19075207	FDM-700	400V 3N 50/60	Extra drying	9,5	702x900x2.070	-

One standard drier (D) for optimal drying of ceramic dishes. Possibility of adding two extra dryers for drying plastic or stainless steel kitchenware.



Disassembly

CODE	MODEL	DESCRIPTION	€
19075212	BELT MODULE DISASSEMBLY KIT	Extra charge for disassembly and shipment of the machinery in several packages.	-

Transformations to other voltages

VOLTAGE	CHARACTERISTICS	€
220-240V 3~ (FG)	220-240V 3~ connection for flight type dishwashers	-

Standard accessories

	Glass basket 19004479	ps	2
	Cutlery basket 19087265	ps	1
	Cups basket 19000488	ps	2

CONCEPT

Flight type diswashers FCO-PW4-RD

FCO-PW4-RD R

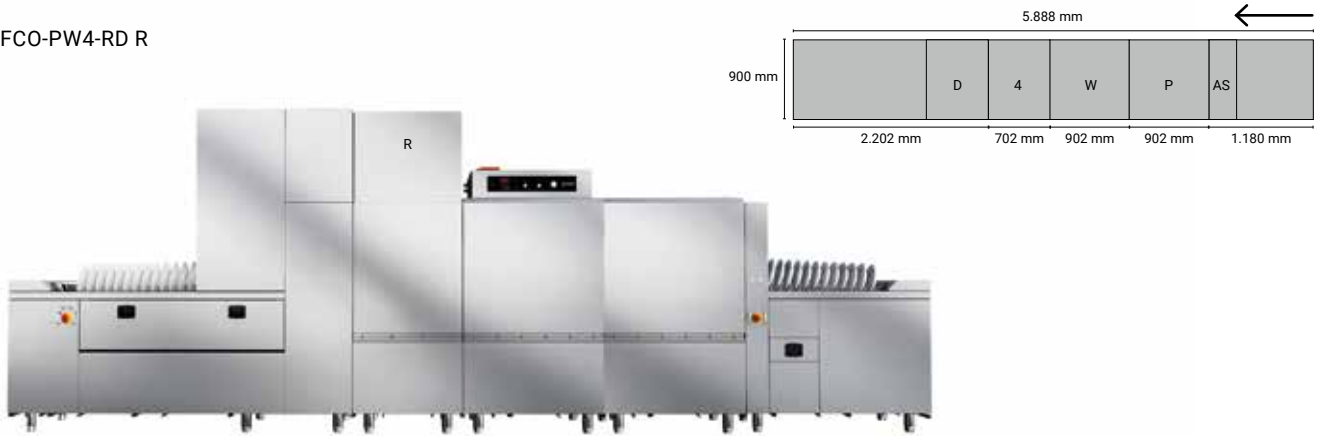

Specific features

- Electromechanical switch that allows you to choose between 3 programmes and two digital displays for the control and visualisation of washing and rinsing temperatures.
- Splash guard module (AS).
- Pre-wash (P): Consisting of 6 upper arms and 5 lower arms. Continuous renewal of the pre-wash water with a constant amount of pre-rinse water, channelling the surplus through a recirculation pump.
- Main wash (W).
- Pre-rinsing / rinsing (4)
 - Pre-rinsing: Consisting of 2 upper and 1 lower prerinsing arms.
 - Rinsing: With one rinsing pump. Type A non-return device in compliance with EN 1717. Consisting of 1 upper and 1 lower rinsing arm. It uses a frequency converter for the rinse pump, which allows to vary the amount of rinse water by automatically adapting it to the selected conveying speed.
- Energy Recovery as standard (R).
- One standard drier (D) for optimal drying of ceramic dishes. Possibility of adding two extra dryers for drying plastic or stainless steel kitchenware.

Technical data

Height (1)	mm	2.070
Height with door open	mm	2.200
Clearance (WxH)	mm	630x440
Supply water pressure min. - max.	bar	1,5-4
Traction motor	kW	0,25
PRE-WASH/WASH		
	PRE-WASH P	MAIN WASH W
Tank capacity	lt	100
Tank heater power	kW	15
Washing pump power	kW	2,6
PRE-RINSE/RINSE		
	PRE- RINSE	RINSE 4
Boiler capacity	lt	-
Tank capacity	lt	30
Boiler heater power	kW	-
Tank resistance power	kW	5
Prerinsing/rinsing pump power	kW	0,26
	DRY D	
Heater power	kW	7,5
Fan power	kW	1,95

(1) Adjustable height (+70/+0 mm)

Programs

PROGRAM	PRODUCTION (PLATES/H)	WATER CONSUMPTION (L/H)	WASH TEMPERATURE (°C)	RINSE TEMPERATURE (°C)	TOTAL POWER (KW)
					COLD WATER INLET WITH ENERGY RECOVERY (RC) 15°-25° 380-400V 3N Simultaneous
Intensive program (DIN-10534)	2.490	190	65	85	53,4
Medium program	3.520	210	65	85	53,4
High capacity program	4.600	230	65	85	53,4

Codes and prices *

MODEL	CODE	HZ	ENTRY DIRECTION	€
FCO-PW4-RD R	19068360	50	Right	-
	19087160	60		
FCO-PW4-RD L	19068366	50	Left	-
	19101265	60		

* The price of the machine does not include the belt, which must be ordered separately.

Belts

CODE	MODEL	DESCRIPTION	€
19074856	PLATE BELT FCO-PW4-RD	Belt for plates and baskets	-
19072700	KITCHENWARE BELT FCO-PW4-RD	Belt for kitchenware (pots and containers)	-
19075209	ISOTHERMAL TRAY BELT FCO-PW4-RD	Belt for isothermal trays	-

Extra Drying

CODE	MODEL	VOLTAGE AND FREQUENCY (HZ)	DESCRIPTION	POWER (KW)	DIMENSIONS (MM)	€
19075207	FDM-700	400V 3N 50/60	Extra drying	9,5	702x900x2.070	-

One standard drier (D) for optimal drying of ceramic dishes. Possibility of adding two extra dryers for drying plastic or stainless steel kitchenware.



Disassembly

CODE	MODEL	DESCRIPTION	€
19075212	BELT MODULE DISASSEMBLY KIT	Extra charge for disassembly and shipment of the machinery in several packages.	-

Transformations to other voltages

VOLTAGE	CHARACTERISTICS	€
220-240V 3~ (FG)	220-240V 3~ connection for flight type dishwashers	-

Standard accessories

	Glass basket 19004479	ps	2
	Cutlery basket 19087265	ps	1
	Cups basket 19000488	ps	2

CONCEPT

Flight type diswashers FCO-P2W4

FCO-P2W4-RD R

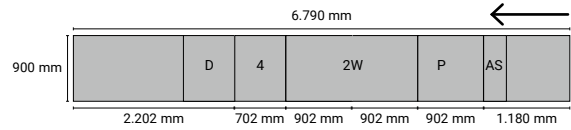

Specific features

- Electromechanical switch that allows you to choose between 3 programmes and two digital displays for the control and visualisation of washing and rinsing temperatures.
- Splash guard module (AS).
- Pre-wash (P): Consisting of 6 upper arms and 5 lower arms. Continuous renewal of the pre-wash water with a constant amount of pre-rinse water, channelling the surplus through a recirculation pump.
- First wash and main wash (2W).
- Pre-Rinse / Rinse (4)
 - Pre-rinsing: Consisting of 3 upper and 1 lower prerinsing arms.
 - Rinsing: With one rinsing pump. Type A non-return device in compliance with EN 1717. Consisting of 1 upper and 1 lower rinsing arm. It uses a frequency converter for the rinse pump, which allows to vary the amount of rinse water by automatically adapting it to the selected conveying speed.
- Energy Recovery as standard (R).
- One standard drier (D) for optimal drying of ceramic dishes. Possibility of adding two extra dryers for drying plastic or stainless steel kitchenware.

Technical data

Height (1)	mm	2.070
Height with door open	mm	2.200
Clearance (WxH)	mm	630x440
Supply water pressure min. - max.	bar	1,5-4
Traction motor	kW	0,25

WASH		PRE-WASH P	FIRST WASH + MAIN WASH 2W
Tank capacity	lt	100	100 + 100
Tank heater power	kW		12 + 15
Washing pump power	kW	2,6	2,6 + 2,6
PRE-RINSE/RINSE		PRE-RINSE	RINSE 4
Boiler capacity	lt	-	20
Tank capacity	lt	30	-
Boiler heater power	kW	-	18
Tank resistance power	kW	5	-
Prerinsing/rinsing pump power	kW	0,26	0,15
DRY			DRY D
Heater power	kW		7,5
Fan power	kW		1,95

(1) Adjustable height (+70/+0 mm)

Programs

PROGRAM	PRODUCTION (PLATES/H)	WATER CONSUMPTION (L/H)	WASH TEMPERATURE (°C)	RINSE TEMPERATURE (°C)	TOTAL POWER (KW)
					COLD WATER INLET WITH ENERGY RECOVERY (RC) 15°-25° 380-400V 3N Simultaneous
Intensive program (DIN-10534)	3.350	220	65	85	68
Medium program	4.970	245	65	85	68
High capacity program	6.600	270	65	85	68

Codes and prices *

MODELO	CÓDIGO	HZ	ENTRY DIRECTION	€
FCO-P2W4-RD R	19074752	50	Right	-
	19108478	60		
FCO-P2W4-RD L	19073649	50	Left	-
	19108476	60		

* The price of the machine does not include the belt, which must be ordered separately.

Belts

CODE	MODEL	DESCRIPTION	€
19073644	PLATE BELT FCO-P2W4-RD	Belt for plates and baskets	-
19072701	KITCHENWARE BELT FCO-P2W4-RD	Belt for kitchenware (pots and containers)	-
19075210	ISOTHERMAL TRAY BELT FCO-P2W4-RD	Belt for isothermal trays	-

Extra Drying

CODE	MODEL	VOLTAGE AND FREQUENCY (HZ)	DESCRIPTION	POWER (KW)	DIMENSIONS (MM)	€
19075207	FDM-700	400V 3N 50/60	Extra drying	9,5	702x900x2.070	-

One standard drier (D) for optimal drying of ceramic dishes. Possibility of adding two extra dryers for drying plastic or stainless steel kitchenware



Disassembly

CODE	MODEL	DESCRIPTION	€
19075212	BELT MODULE DISASSEMBLY KIT	Extra charge for disassembly and shipment of the machinery in several packages.	-

Transformations to other voltages

VOLTAGE	CHARACTERISTICS	€
220-240V 3~ (FG)	220-240V 3~ connection for flight type dishwashers	-

Standard accessories

	Glass basket 19004479	un	2
	Cutlery basket 19087265	un	1
	Cups basket 19000488	un	2

CONCEPT

Flight type diswashers FCO-P3W4-RDD

FCO-P3W4-RDD R

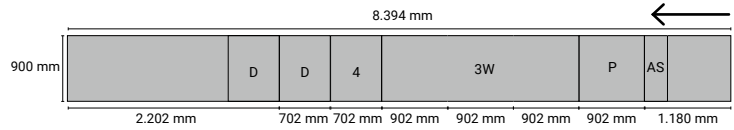

Specific features

- Electromechanical switch that allows you to choose between 3 programmes and two digital displays for the control and visualisation of washing and rinsing temperatures.
- Splash guard module (AS).
- Pre-wash (P): Consisting of 6 upper arms and 5 lower arms. Continuous renewal of the pre-wash water with a constant amount of pre-rinse water, channelling the surplus through a recirculation pump.
- First wash, second wash and main wash (3W)
- Pre-rising / Rinsing (4)
 - Pre-rinsing: Consisting of 3 upper and 1 lower prerinsing arms.
 - Rinsing: With one rinsing pump. Type A non-return device in compliance with EN 1717. Consisting of 1 upper and 1 lower rinsing arm. It uses a frequency converter for the rinse pump, which allows to vary the amount of rinse water by automatically adapting it to the selected conveying speed.
- Energy Recovery as standard (R).
- Two standard driers (D) for optimal drying of ceramic dishes. Possibility of adding one extra dryer for drying plastic or stainless steel kitchenware.

Technical data

Height (1)	mm	2.070
Height with door open	mm	2.200
Clearance (WxH)	mm	630x440
Supply water pressure min. - max.	bar	1,5-4
Traction motor	kW	0,25

WASH		PRE-WASH P	FIRST WASH, SECOND WASH AND MAIN WASH 3W
Tank capacity	lt	100	100 + 100 + 100
Tank heater power	kW		12 + 12 + 15
Washing pump power	kW	2,6	2,6 + 2,6 + 2,6
PRE-RINSE/RINSE		PRE-RINSE	RINSE 4
Boiler capacity	lt	-	20
Tank capacity	lt	30	-
Boiler heater power	kW	-	18
Tank heater power	kW	5	-
Prerinsing/rinsing pump power	kW	0,26	0,15
DRY			DRY DD
Heater power	kW		2x7,5
Fan power	kW		2x1,95

(1) Adjustable height (+70/+0 mm)

Programs

PROGRAM	PRODUCTION (PLATES/H)	WATER CONSUMPTION (L/H)	WASH TEMPERATURE (°C)	RINSE TEMPERATURE (°C)	TOTAL POWER (KW)
					COLD WATER INLET WITH ENERGY RECOVERY (RC) 15°-25° 380-400V 3N Simultaneous
Intensive program (DIN-10534)	4.275	220	65	85	92,05
Medium program	6.410	245	65	85	92,05
High capacity program	8.600	270	65	85	92,05

Codes and prices*

MODEL	CODE	HZ	ENTRY DIRECTION	€
FCO-P3W4-RDD R	19111197	50	Right	-
	19111198	60		
FCO-P3W4-RDD L	19111088	50	Left	-
	19111196	60		

* The price of the machine does not include the belt, which must be ordered separately.

Belts

CODE	MODEL	DESCRIPTION	€
19111199	PLATE BELT FCO-P3W4-RDD	Belt for plates and baskets	-
19111202	KITCHENWARE BELT FCO-P3W4-RDD	Belt for kitchenware (pots and containers)	-
19111200	ISOTHERMAL TRAY BELT FCO-P3W4-RDD	Belt for isothermal trays	-

Extra Drying

CODE	MODEL	VOLTAGE AND FREQUENCY (HZ)	DESCRIPTION	POWER (KW)	DIMENSIONS (mm)	€
19075207	FDM-700	400V 3N 50/60	Extra drying	9,5	702x900x2.070	-

Two standard driers (DD) for optimal drying of ceramic dishes. Possibility of adding one extra dryer for drying plastic or stainless steel kitchenware



Disassembly

CODE	MODEL	DESCRIPTION	€
19075212	BELT MODULE DISASSEMBLY KIT	Extra charge for disassembly and shipment of the machinery in several packages.	-

Transformations to other voltages

VOLTAGE	CHARACTERISTICS	€
220-240V 3~ (FG)	220-240V 3~ connection for flight type dishwashers	-

Standard accessories

	Glass basket 19004479	un	2
	Cutlery basket 19087265	un	1
	Cups basket 19000488	un	2



The best accessory for
our wide range
of dishwashers.



Access the website

Baskets

Basket for crockery, cutlery and trays **245**



Glass baskets **246**

Basket for crockery, cutlery and trays

	CODE	MODEL	DESCRIPTION	Ø MÁX (mm)	PRODUCT CAPACITY	DIMENSIONS (mm)	€
	19000487	CP-16/18	Plates basket	Ø 230 Ø 320	16-18 8-9	500x500x110	-
	19004479	CP-12	Deep plates basket (75 mm)	Ø 230 Ø 320	12 6	500x500x140	-
	19000484	CT-10	Glass basket	-	-	500x500x110	-
	19087265	CT-10 R	Cutlery basket	-	-	500x500x110	-
	19000483	CB-7	Self-service trays basket	-	7	500x500x110	-
	19082432	WRPG-40	Glass basket	-	-	400x400x110	-
	19110751	WRPGR-40	Round glass basket	-	-	Ø 400x180	-
	19110752	WRHR-40	Support for round basket Ø 400	-	-	400x400x110	-
	19084452	WRWP-11	Plates insert	-	11	400x400x110	-
	19000792	CU-7	Cutlery insert	-	15	105x105x130	-
	19102721	CU-GW	Cutlery insert	-	9	Ø 96x104	-

Glass baskets

Rod baskets

	CODE	MODEL	DIVISIONS	Ø MÁX (MM)	DIMENSIONS (MM)	€
	19107616	WRWG-50	5	92	500x500x190	-
	19107614	WRWG-40	4	92	400x400x183	-

Plastic baskets



500x500x140

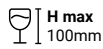

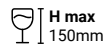

500x500x190

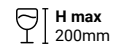

500x500x240



	PRODUCT CAPACITY	CODE	MODEL	€	CODE	MODEL	€	CODE	MODEL	€
	16	19000488	CV-16/105	-	19000489	CV-16/155	-	19000490	CV-16/205	-
	25	19000491	CV-25/105	-	19000492	CV-25/155	-	19000493	CV-25/205	-
	36	19000494	CV-36/105	-	19000495	CV-36/155	-	19000496	CV-36/205	-