



Commercial
Refrigeration

A commitment to a more sustainable world.



The iKOLD generation has been designed with the kitchen professional in mind. A renewed aesthetic, perfectly integrated with the Fagor Professional brand and our Catering equipment (cooking blocks, ovens, refrigeration, neutral furniture...) for professional kitchens.

An optimized refrigeration technology, reaching highest energy efficiency index with lowest energy consumption.

Cooling devices developed with Hydrocarbon (HC) gases with Global Warming Potential (GWP) = 3, in commitment to our sustainability values.

Designed with high efficiency electronic components which guarantees high cooling performance for optimal food preservation.

Complete range of product (storage cabinets and counters, preparation counters, blast chillers, bar coolers etc...) focused on food preparation, chilling and storing.

Thus, contemplating your needs and our experience as the first manufacturer of Commercial Refrigeration in Europe, the iKOLD generation was born.



Efficiency

Low impact and up to 65% lower consumption.



Performance

Durability and quality, guarantee of preservation for your food.



Versatility

Wide range of solutions for your kitchen.



Sustainability

Committed to environment Hydrocarbon gases (HC) in all product range.



Discover in detail how FagorKonnnect can specifically enhance the functionality of our refrigeration equipment.



Specific graphs designed for the analysis of refrigeration equipment:

To perform an analysis of refrigeration equipment focusing on specific aspects such as device status, compressor active hours, and door status, you could use intuitive and specific graphs that highlight the information.



Detailed information displayed in real time:

It will show key data to monitor refrigeration equipment and perform actions such as setting parameters, switching the equipment and light on or off, or activating a defrost, optimising its performance.

View and download the HACCP of a particular device:

HACCP for a specific device is available. Obtains a graph over a range of selected dates.



Fagor Professional



Commercial refrigeration

Refrigerated uprights	255
Refrigerated counters	285
Preparation counters.....	315
Bast chillers	333
Bar line	345
Wine cellars.....	361
Ice makers.....	371

 **STOCK** This option corresponds to 50 Hz models.

Fagor Professional



European refrigeration for
demanding professionals.



Refrigerated uprights

— Features.....	257
— Advance GN 2/1	261
— Concept monoblock GN 2/1	265
— Concept GN 2/1	269
— Concept GN 2/1 dual temperature	275
— Concept GN 1/1	276
— Snack	277
— Snack dual temperature	279
— Pastry.....	281
— Fish.....	283
— Accessories	284

Special units or any variations from the standard model must be assembled at the factory at an additional charge over the standard model's price.

Please, contact Fagor Professional for any other variation or option that is not included on this list.

Efficient. Profitable. Sustainable.



A

B

ADVANCE**CONCEPT MONOBLOCK**

AUP-11G

MUP-11G

Capacity (N° of shelves per door)

24

23

Size of shelves

GN 2/1

GN 2/1

Energy class

A

B

Insulation (mm)

80

60

Refrigerant + / -

R600a / R290

R600a / R290

Climate class (1 door)

5

4

Multiflow

Yes

Yes

HACCP compliant

Yes

No

Electronic control

Capacitive 5"

Capacitive 3"

Interface





C

C

D

CONCEPT

SNACK CABINETS

PASTRY CABINETS

FISH CABINETS

CUP-11G

CUP-11S

CUP-11B

CU-11F

23

18

20

7

GN 2/1

560 x 542

EN 60x40

EN 60x40

C

C

E

-

60

50

50

50

R600a / R290

R600a / R290

R290

R290

4

4

4

4

No

No

No

No

No

No

No

No

Capacitive 3"

Capacitive 3"

Capacitive 3"

Capacitive 3"



Refrigeration upright features

Electronic control Easy to use

Functional and intuitive electronic control with capacitive keyboard that allows direct access to main functions.



ECO function

Function that optimizes the performance by automatically setting temperatures, when doors are not opened so that the cooling unit works only when needed and always, efficiently.



Climatic Class 5

Devices tested in harshest working environments, which ensure product preservation in high temperature and humidity conditions.

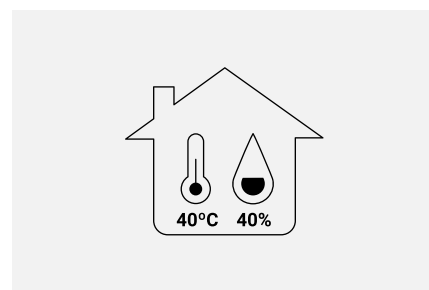

Embedded tray guides

The embedded tray guides facilitate cleaning in the cabinets. They also increase storage flexibility, allowing it to be adapted to the user's needs.



Led lighting on the inside

The low energy consumption LED lights, strategically located on the sides, provide optimal illumination of the entire compartment.



Maximum stability

Height-adjustable stainless steel legs as standard. Height of the legs can be adjusted individually. In addition, there is also the option to choose swivel wheels or legs for marine.

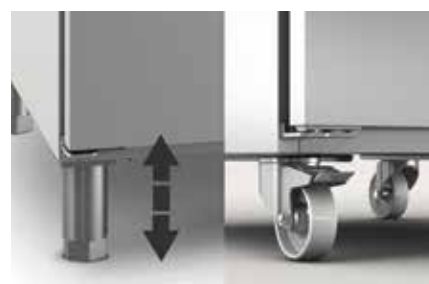

Automatic closing door

Hinged doors with automatic return for a perfect closing that minimize temperature gain. Doors have a 120° dwell position and close automatically at less than 90°.



Pivotable panel

Pivotable panel with better access to control that facilitates service, thus enlarging the useful life of the equipment.



Door Lock

Option to equip the upright with a door lock in full door models. Standard in Advance line, as well as, all display upright.



Optimal refrigeration circuit

Internally designed forced draft cooling system with low consumption electronic components to guarantee optimal equipment efficiency and performance.

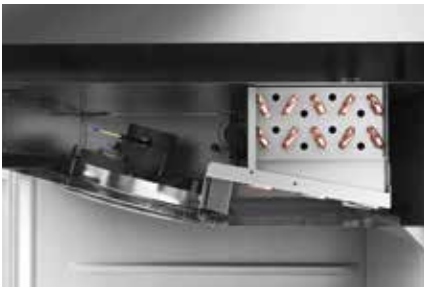

Accessible door opening

Opening pedal as an option in all cabinets range, allowing to access the interior in a comfortable way.



Connectivity

Guarantee the correct conservation of stored food through precise monitoring of your refrigeration equipment thanks to Fagor Konnect.



Multiflow

Optimal air circulation system that guarantees a balanced and constant distribution throughout the equipment, so that the temperature remains uniform. It helps preserve food for longer.



Removable door gasket

Removable triple camera pull-out/push-in magnetic door gasket to keep maximum hygiene and maintain the insulating properties.



Higher insulation thicknesses

Insulation thickness is a key factor in preventing losing cold. The new iKOLD generation increases the insulation levels of all mid ranges to provide greater cooling efficiency.



Integrated handles

Stainless steel doors with ergonomic, full-length, robust, perfectly integrated handle. that ensures practical opening of the drawers and avoids dust and dirt collection.



Option available in the ADVANCE range (K Connectivity).



ADVANCE

GN 2/1 700



AUP-11G

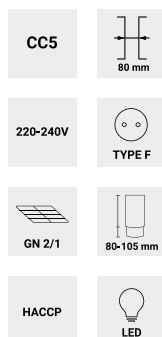

General characteristics

- Interior and exterior completely built with AISI-304 stainless steel.
- Embedded inner guides with 24 different level position 55 mm distance among them, enable more convenient cleaning operations without difficulties.
- 10 HACCP alarms capacity which are store when high temperature variation and devices power failure.
- Optimal air circulation system that guarantees a balanced and constant distribution throughout the equipment, so that the temperature remains uniform. It helps preserve food for longer.
- Removable and height adjustable epoxy coated GN 2/1 grids with a maximum loading capacity of up to 40 kg.



	MODEL	DIMENSIONS (mm)	VOLUME (L)	TEMPERATURE (°C)	DEFROST	GAS	COOLING POWER (kW)	ELECTRIC POWER (kW)	ANNUAL CONSUMPTION (kWh)	ENERGY EFFICIENCY CLASS	FREQUENCY	REFERENCE	€
STOCK	AUP-11G	693 x 856 x 2.106	610	0 +8 °C	Stop	R-600a	0,361 (1)	0,158	A	336 (4)	50 Hz	19089406	-
						R290	0,398 (1)	0,31	-	-	60 Hz	19089395	-
	AUPT-11G	693 x 856 x 2.106	610	-2 +8 °C	Electric	R-600a	0,361 (1)	0,688	B	451 (4)	50 Hz	19103143	-
						R290	0,398 (1)	0,84	-	-	60 Hz	19110956	-
STOCK	AUN-11G	693 x 856 x 2.106	610	-18 -22 °C	Hot gas (3)	R290	0,535 (2)	0,471	D	2.752 (4)	50 Hz	19089398	-
						R290	0,72 (2)	0,496	-	-	60 Hz	19089399	-

(1) Evap. -10°C/ Cond. 45°C

(2) Evap. -25°C/ Cond. 45°C

(3) Remote Group Electric

(4) According to EN22041 standard

Options

		AUP-11G (€)	AUPT-11G (€)	AUN-11G (€)
Connectivity	K	0	0	0
G type plug	CI 	0	0	0
Opposite opening	OP	0	0	0
Lock	LC	●	●	●
Castors	C	0	0	0
Remote group	RG	0	0	0
Back in Stainless Steel	BS	0	0	0
Frame heater	FH	0	0	●
Pedal	PD	0	0	0

Standard Accessories

	CODE	DESCRIPTION		11G	€
	19097787	GN 2/1 epoxy grid	pc	3	-

Other Accessories

	CODE	DESCRIPTION	€
	19048712	Meat bar GN uprights single body	-

ADVANCE

GN 2/1 1400



AUP-22G

- CC5
- 220-240V
- GN 2/1
- HACCP

General characteristics

- Interior and exterior completely built with AISI-304 stainless steel.
- Embedded inner guides with 24 different level position 55 mm distance among them, enable more convenient cleaning operations without difficulties.
- 10 HACCP alarms capacity which are store when high temperature variation and devices power failure.
- Optimal air circulation system that guarantees a balanced and constant distribution throughout the equipment, so that the temperature remains uniform. It helps preserve food for longer.
- Removable and height adjustable epoxy coated GN 2/1 grids with a maximum loading capacity of up to 40 kg.



MODEL	DIMENSIONS (mm)	VOLUME (L)	TEMPERATURE (°C)	DEFROST	GAS	COOLING POWER (kW)	ELECTRIC POWER (kW)	ANNUAL CONSUMPTION (kWh)	ENERGY EFFICIENCY CLASS	FREQUENCY	REFERENCE	€
AUP-22G	1.358 x 856 x 2.106	1.332	0 +8 °C	Stop	R-600a	0,436 (1)	0,192	C	832 (4)	50 Hz	19089396	-
					R-600a	0,437 (1)	0,209	-	-	60 Hz	19089397	-
AUPT-22G	1.358 x 856 x 2.106	1.332	-2 +8 °C	Electric	R-600a	0,436 (1)	0,972	C	841 (4)	50 Hz	19103142	-
					R-600a	0,437 (1)	0,989	-	-	60 Hz	19110957	-
AUN-22G	1.358 x 856 x 2.106	1.332	-18 -22 °C	Hot gas (3)	R290	0,907 (2)	0,749	D	4.599 (4)	50 Hz	19089420	-
					R290	0,799 (2)	0,831	-	-	60 Hz	19089421	-
AUN-22G CC5	1.358 x 856 x 2.106	1.332	-18 -22 °C	Hot gas (3)	R290	0,907 (2)	0,825	D	4.234 (4)	50 Hz	19089422	-
					R290	0,799 (2)	0,907	-	-	60 Hz	19110958	-

(1) Evap. -10°C/ Cond. 45°C (2) Evap. -25°C/ Cond. 45°C (3) Remote Group Electric (4) According to EN22041 standard

Options

		AUP-22G (€)	AUPT-22G (€)	AUN-22G (€)
Connectivity	K	o	o	o
G type plug	CI	o	o	o
Lock	LC	●	●	●
Castors	C	o	o	o
Remote group	RG	o	o	o
Back in Stainless Steel	BS	o	o	o
Frame heater	FH	o	o	●
Pedal	PD	o	o	o

Standard Accessories

	CODE	DESCRIPTION		22G	€
	19097787	GN 2/1 epoxy coated grid	pc	6	-
	19014778	Tray support guides L=562mm	pc	3	-

Other Accessories

	CODE	DESCRIPTION	€
	19048713	Meat bar GN uprights double body	-

GN 2/1 Display 700



AUP-11G GD

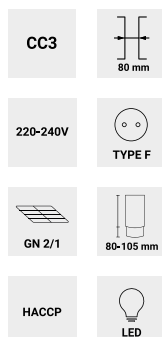

General characteristics

- Interior and exterior completely built with AISI-304 stainless steel.
- Embedded inner guides with 24 different level position 55 mm distance among them, enable more convenient cleaning operations without difficulties.
- 10 HACCP alarms capacity which are store when high temperature variation and devices power failure.
- Optimal air circulation system that guarantees a balanced and constant distribution throughout the equipment, so that the temperature remains uniform. It helps preserve food for longer.
- Glass door:
 - Refrigeration Double-glazed doors insulated with low thermal emissivity to reduce heat transfer in refrigeration.
 - Freezer and tropicalized uprights: Triple glazed door with electric heating system to avoid any kind of condensation in the doors.
- Removable and height adjustable epoxy coated GN 2/1 grids with a maximum loading capacity of up to 40 kg.



MODEL	DIMENSIONS (mm)	VOLUME (L)	TEMPERATURE (°C)	DEFROST	GAS	COOLING POWER (kW)	ELECTRIC POWER (kW)	ANNUAL CONSUMPTION (kWh)	ENERGY EFFICIENCY CLASS	FREQUENCY	REFERENCE	€
AUP-11G GD	693 x 856 x 2.106	610	0 +8 °C	Stop	R-600a	0,361 (1)	0,158	A	555 (5)	50 Hz	19089423	-
					R290	0,398 (1)	0,313	-	-	60 Hz	19090872	-
AUPT-11G GD	693 x 856 x 2.106	610	0 +8 °C	Electric	R-600a	0,361 (1)	0,768	B	994 (5)	50 Hz	19106080	-
					R290	0,398 (1)	0,92	-	-	60 Hz	19110960	-
AUN-11G GD	693 x 856 x 2.106	610	-18 -22 °C	Hot gas (3)	R290	0,535 (2)	0,551	E	5.143 (5)	50 Hz	19106024	-
					R290	0,72 (2)	0,576	-	-	60 Hz	19110961	-

(1) Evap. -10°C/ Cond. 45°C

(2) Evap. -25°C/ Cond. 45°C

(3) Remote Group Electric

(5) According to EN23953 standard

Options

		AUP-11G GD (€)	AUPT-11G GD (€)	AUN-11G GD (€)
Connectivity	K	o	o	o
G type plug	Cl	o	o	o
Opposite opening	OP	o	o	o
Lock	LC	●	●	●
Castors	C	o	o	o
Remote group	RG	o	o	o
Back in Stainless Steel	BS	o	o	o
Frame heater	FH	o	o	●
Pedal	PD	o	o	o
Glass Door	GD	●	●	●

Standard Accessories

CODE	DESCRIPTION	11G	€
19097787	GN 2/1 epoxy grid	pc 3	-

Other Accessories

CODE	DESCRIPTION	€
19048712	Meat bar GN uprights single body	-

ADVANCE

GN 2/1 Display 1400



AUP-22G GD

- CC3
- 220-240V
- GN 2/1
- HACCP

General characteristics

- Interior and exterior completely built with AISI-304 stainless steel.
- Embedded inner guides with 24 different level position 55 mm distance among them, enable more convenient cleaning operations without difficulties.
- 10 HACCP alarms capacity which are store when high temperature variation and devices power failure.
- Optimal air circulation system that guarantees a balanced and constant distribution throughout the equipment, so that the temperature remains uniform. It helps preserve food for longer.
- Glass door:
 - Refrigeration Double-glazed doors insulated with low thermal emissivity to reduce heat transfer in refrigeration.
 - Freezer and tropicalized uprights: Triple glazed door with electric heating system to avoid any kind of condensation in the doors.
- Removable and height adjustable epoxy coated GN 2/1 grids with a maximum loading capacity of up to 40 kg.



MODEL	DIMENSIONS (mm)	VOLUME (L)	TEMPERATURE (°C)	DEFROST	GAS	COOLING POWER (kW)	ELECTRIC POWER (kW)	ANNUAL CONSUMPTION (kWh)	ENERGY EFFICIENCY CLASS	FREQUENCY	REFERENCE	€
AUP-22G GD	1.358 x 856 x 2.106	1.332	0 +8 °C	Stop	R-600a	0,436 (1)	0,192	C	1.374 (5)	50 Hz	19089424	-
					R-600a	0,437 (1)	0,213	-	-	60 Hz	19090871	-
AUPT-22G GD	1.358 x 856 x 2.106	1.332	0 +8 °C	Electric	R-600a	0,436 (1)	1,132	B	1.510 (5)	50 Hz	19106086	-
					R-600a	0,437 (1)	1,149	-	-	60 Hz	19110962	-
AUN-22G GD	1.358 x 856 x 2.106	1.332	-18 -22 °C	Hot gas (3)	R290	0,907 (2)	0,909	E	9.123 (5)	50 Hz	19106053	-
					R290	0,799 (2)	0,991	-	-	60 Hz	19110963	-

(1) Evap. -10°C/ Cond. 45°C (2) Evap. -25°C/ Cond. 45°C (3) Remote Group Electric (5) According to EN23953 standard

Options

		AUP-22G (€)	AUPT-22G (€)	AUN-22G (€)
Connectivity	K	o	o	o
G type plug	CI	o	o	o
Lock	LC	●	●	●
Castors	C	o	o	o
Remote group	RG	o	o	o
Back in Stainless Steel	BS	o	o	o
Frame heater	FH	o	o	●
Pedal	PD	o	o	o
Glass Door	GD	●	●	●

Standard Accessories

	CODE	DESCRIPTION		22G	€
	19097787	GN 2/1 epoxy coated grid	pc	6	-
	19014778	Tray support guides L=562mm	pc	3	-

Other Accessories

	CODE	DESCRIPTION	€
	19048713	Meat bar GN uprights double body	-

CONCEPT

Monoblock GN 2/1 700



MUP-11G

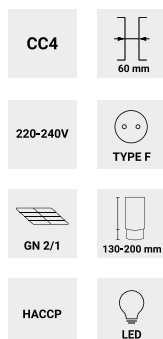

General characteristics

- Interior constructed with AISI-304 stainless steel exterior in food grade stainless steel.
- Embedded inner guides with 23 different level position 55 mm distance among them, enable more convenient cleaning operations without difficulties.
- Internally designed monoblock cooling system. Top mounted evaporator ensure an easy maintenance of refrigeration unit, as well as an optimized use of storage compartment.
- Removable and height adjustable epoxy coated GN 2/1 grids with a maximum loading capacity of up to 40 kg.



MODEL	DIMENSIONS (mm)	VOLUME (L)	TEMPERATURE (°C)	DEFROST	GAS	COOLING POWER (kW)	ELECTRIC POWER (kW)	ANNUAL CONSUMPTION (kWh)	ENERGY EFFICIENCY CLASS	FREQUENCY	REFERENCE	€
MUP-11G	653 x 796 x 1.996	572	0 +8 °C	Stop	R-600a	0,274 (1)	0,143	B	423 (4)	50 Hz	19089425	-
					R290	0,398 (1)	0,253	-	-	60 Hz	19090283	-
MUP-12G	653 x 796 x 1.996	572	0 +8 °C	Stop	R-600a	0,274 (1)	0,143	B	423 (4)	50 Hz	19089426	-
					R290	0,398 (1)	0,253	-	-	60 Hz	19090321	-
MUN-11G	653 x 796 x 1.996	572	-18 -22 °C	Electric	R290	0,364 (2)	0,328	D	2.686 (4)	50 Hz	19089430	-
					R290	0,381 (2)	0,369	-	-	60 Hz	19089431	-
MUN-12G	653 x 796 x 1.996	572	-18 -22 °C	Electric	R290	0,364 (2)	0,334	D	2.686 (4)	50 Hz	19089432	-
					R290	0,381 (2)	0,375	-	-	60 Hz	19089433	-

(1) Evap. -10°C/ Cond. 45°C

(2) Evap. -25°C/ Cond. 45°C

(3) Remote Group Electric

(4) According to EN22041 standard

Options

			MUP-11G (€)	MUP-12G (€)	MUN-11G (€)	MUN-12G (€)
G type plug	CI		0	0	0	0
Opposite opening	OP		0	0	0	0
Lock	LC		0	-	0	-
Castors	C		0	0	0	0
Remote group	RG		0	0	0	0
Back in Stainless Steel	BS		0	0	0	0
Frame heater	FH		0	0	●	●
Pedal	PD		0	-	0	-

Standard Accessories

CODE	DESCRIPTION	11G	12G	€	
19097787	GN 2/1 epoxy grid	pc	3	3	-

Other Accessories

CODE	DESCRIPTION	€
19048712	Meat bar GN uprights single body	-

CONCEPT

Monoblock GN 2/1 1400



MUP-22G

- CC4**
- 220-240V**
- GN 2/1**
- HACCP**

General characteristics

- Interior constructed with AISI-304 stainless steel exterior in food grade stainless steel.
- Embedded inner guides with 23 different level position 55 mm distance among them, enable more convenient cleaning operations without difficulties.
- Internally designed monoblock cooling system. Top mounted evaporator ensure an easy maintenance of refrigeration unit, as well as an optimized use of storage compartment.
- Removable and height adjustable epoxy coated GN 2/1 grids with a maximum loading capacity of up to 40 kg.



MODEL	DIMENSIONS (mm)	VOLUME (L)	TEMPERATURE (°C)	DEFROST	GAS	COOLING POWER (kW)	ELECTRIC POWER (kW)	ANNUAL CONSUMPTION (kWh)	ENERGY EFFICIENCY CLASS	FREQUENCY	REFERENCE	€
MUP-22G	1.318 x 796 x 1.996	1.144	0 +8 °C	Stop	R-600a	0,436 (1)	0,184	C	756 (4)	50 Hz	19089427	-
					R-600a	0,437 (1)	0,201	-	-	60 Hz	19090322	-
MUP-23G	1.318 x 796 x 1.996	1.144	0 +8 °C	Stop	R-600a	0,436 (1)	0,184	C	756 (4)	50 Hz	19089428	-
					R-600a	0,437 (1)	0,201	-	-	60 Hz	19090323	-
MUP-24G	1.318 x 796 x 1.996	1.144	0 +8 °C	Stop	R-600a	0,436 (1)	0,184	C	756 (4)	50 Hz	19089429	-
					R-600a	0,437 (1)	0,201	-	-	60 Hz	19090324	-
MUN-22G	1.318 x 796 x 1.996	1.144	-18 -22 °C	Electric	R290	0,735 (2)	0,592	E	4.855 (4)	50 Hz	19089434	-
					R290	0,802 (2)	0,648	-	-	60 Hz	19089435	-
MUN-23G	1.318 x 796 x 1.996	1.144	-18 -22 °C	Electric	R290	0,735 (2)	0,598	E	4.855 (4)	50 Hz	19089436	-
					R290	0,802 (2)	0,654	-	-	60 Hz	19089437	-
MUN-24G	1.318 x 796 x 1.996	1.144	-18 -22 °C	Electric	R290	0,735 (2)	0,592	E	4.855 (4)	50 Hz	19089438	-
					R290	0,802 (2)	0,66	-	-	60 Hz	19089439	-

(1) Evap. -10°C/ Cond. 45°C (2) Evap. -25°C/ Cond. 45°C (3) Remote Group Electric (4) According to EN22041 standard

Options

		MUP-22G (€)	MUP-23G (€)	MUP-24G (€)	MUN-22G (€)	MUN-23G (€)	MUN-24G (€)
G type plug	CI	0	0	0	0	0	0
Lock	LC	0	-	-	0	-	-
Castors	C	0	0	0	0	0	0
Remote group	RG	0	0	0	0	0	0
Back in Stainless Steel	BS	0	0	0	0	0	0
Frame heater	FH	0	0	0	●	●	●
Pedal	PD	0	-	-	0	-	-

Standard Accessories

CODE	DESCRIPTION	22G	23G	24G	€
19097787	GN 2/1 epoxy grid	pc 6	6	6	-
19014778	Tray support guides L=562mm	pc 3	3	3	-

Other Accessories

CODE	DESCRIPTION	€
19048713	Meat bar GN uprights double body	-

CONCEPT

Monoblock GN 2/1 Display



- CC3**
- 220-240V**
- GN 2/1**
- HACCP**

General characteristics

- Interior constructed with AISI-304 stainless steel exterior in food grade stainless steel.
- Embedded inner guides with 23 different level position 55 mm distance among them, enable more convenient cleaning operations without difficulties.
- Double-glazed doors insulated with low thermal emissivity to reduce heat transfer with ergonomic handle.
- Internally designed monoblock cooling system. Top mounted evaporator ensure an easy maintenance of refrigeration unit, as well as an optimized use of storage compartment.
- Removable and height adjustable epoxy coated GN 2/1 grids with a maximum loading capacity of up to 40 kg.



MODEL	DIMENSIONS (mm)	VOLUME (L)	TEMPERATURE (°C)	DEFROST	GAS	COOLING POWER (kW)	ELECTRIC POWER (kW)	ANNUAL CONSUMPTION (kWh)	ENERGY EFFICIENCY CLASS	FREQUENCY	REFERENCE	€
MUP-11G GD	653 x 796 x 1.996	572	0 +8 °C	Stop	R-600a	0,274 (1)	0,146	B	1.132 (5)	50 Hz	19089440	-
					R290	0,398 (1)	0,256	-	-	60 Hz	19090327	-
MUP-22G GD	1.318 x 796 x 1.996	1.144	0 +8 °C	Stop	R-600a	0,436 (1)	0,19	B	1.570 (5)	50 Hz	19089441	-
					R-600a	0,437 (1)	0,207	-	-	60 Hz	19090328	-

(1) Evap. -10°C/ Cond. 45°C (2) Evap. -25°C/ Cond. 45°C (3) Remote Group Electric (5) According to EN23953 standard

Options

		MUP-11G GD (€)	MUP-22G GD (€)
G type plug	CI	o	o
Opposite opening	OP	o	-
Lock	LC	●	●
Castors	C	o	o
Remote group	RG	o	o
Back in Stainless Steel	BS	o	o
Frame heater	FH	o	o
Pedal	PD	o	o
Glass door	GD	●	●

Standard Accessories

CODE	DESCRIPTION	11G	22G	€
19097787	GN 2/1 epoxy grid	pc 3	6	-
19014778	Tray support guides L=562mm	pc -	3	-

Other Accessories



CODE	DESCRIPTION	11G	22G	€
19048712	Meat bar GN uprights single body	X		-
19048713	Meat bar GN uprights double body		X	-

CONCEPT

Monoblock GN 2/1 Dual Temperature



MUD-22G/M

- CC4 
- 220-240V 
- GN 2/1 
- HACCP

General characteristics

- Interior constructed with AISI-304 stainless steel exterior in food grade stainless steel.
- Embedded inner guides with 23 different level position 55 mm distance among them, enable more convenient cleaning operations without difficulties.
- Internally designed monoblock cooling system. Top mounted evaporator ensure an easy maintenance of refrigeration unit, as well as an optimized use of storage compartment.
- Removable and height adjustable epoxy coated GN 2/1 grids with a maximum loading capacity of up to 40 kg.
- Suitable for 1 x GN2/1 or 2 x GN1/1 food containers.
- Mixed refrigeration and freezer cabinet with two independent modules with their respective refrigeration units and electronic controls.
 - Refrigeration compartment working temperature: 0 °C, +8 °C.
 - Freezer compartment working temperature: -18 °C, -22 °C.



MODEL	DIMENSIONS (mm)	VOLUME (L)	COMPARTMENT	TEMPERATURE (°C)	DEFROST	GAS	COOLING POWER (kW)	ELECTRIC POWER (kW)	FREQUENCY	REFERENCE	€
MUD-22G/M	1.318 x 796 x 1.996	1.144	+ / -	0 +8 °C / -18 -22 °C	Stop / Electric	R-600a	0,274 (1)	0,471	50 Hz	19089442	-
						R290	0,398 (2)	0,622	60 Hz	19089443	-

(1) Evap. -10°C/ Cond. 45°C (2) Evap. -25°C/ Cond. 45°C

Options

			MUD-22G/M (€)
G type plug	CI		0
Lock	LC		0
Castors	C		0
Back in Stainless Steel	BS		0
Frame heater	FH		0
Pedal	PD		0

Standard Accessories

CODE	DESCRIPTION	22G	€
 19097787	GN 2/1 epoxy grid	pc	6 -

Other Accessories

CODE	DESCRIPTION	€
 19048713	Meat bar GN uprights double body	-

CONCEPT

GN 2/1 700



CUP-11G

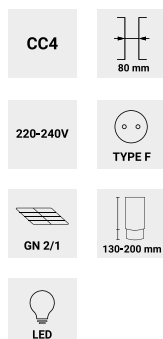

General characteristics

- Interior constructed with AISI-304 stainless steel exterior in food grade stainless steel.
- Embedded inner guides with 23 different level position 55 mm distance among them, enable more convenient cleaning operations without difficulties.
- Removable and height adjustable epoxy coated GN 2/1 grids with a maximum loading capacity of up to 40 kg.



	MODEL	DIMENSIONS (mm)	VOLUME (L)	TEMPERATURE (°C)	DEFROST	GAS	COOLING POWER (kW)	ELECTRIC POWER (kW)	ANNUAL CONSUMPTION (kWh)	ENERGY EFFICIENCY CLASS	FREQUENCY	REFERENCE	€
STOCK	CUP-11G	653 x 842 x 2.040	543	0 +8 °C	Stop	R-600a	0,361 (1)	0,183	C	548 (4)	50 Hz	19089444	-
						R290	0,398 (1)	0,275	-	-	60 Hz	19089445	-
	CUP-12G	653 x 842 x 2.040	543	0 +8 °C	Stop	R-600a	0,361 (1)	0,183	C	548 (4)	50 Hz	19089446	-
						R290	0,398 (1)	0,275	-	-	60 Hz	19089447	-
STOCK	CUPT-11G	653 x 842 x 2.040	543	-2 +8 °C	Electric	R-600a	0,361 (1)	0,713	C	604 (4)	50 Hz	19103938	-
						R290	0,398 (1)	0,805	-	-	60 Hz	19110989	-
	CUPT-12G	653 x 842 x 2.040	543	-2 +8 °C	Electric	R-600a	0,361 (1)	0,713	C	604 (4)	50 Hz	19106019	-
						R290	0,398 (1)	0,805	-	-	60 Hz	19110990	-
STOCK	CUN-11G	653 x 842 x 2.040	543	-18 -22 °C	Hot gas (3)	R290	0,535 (2)	0,471	D	2.714 (4)	50 Hz	19089454	-
						R290	0,72 (2)	0,496	-	-	60 Hz	19089455	-
	CUN-12G	653 x 842 x 2.040	543	-18 -22 °C	Hot gas (3)	R290	0,535 (2)	0,477	D	2.714 (4)	50 Hz	19089456	-
						R290	0,72 (2)	0,502	-	-	60 Hz	19089457	-

(1) Evap. -10°C/ Cond. 45°C

(2) Evap. -25°C/ Cond. 45°C

(3) Remote Group Electric

(4) According to EN22041 standard

Options

			CUP-11G (€)	CUP-12G (€)	CUPT-11G (€)	CUPT-12G (€)	CUN-11G (€)	CUN-12G (€)
G type plug	CI		0	0	0	0	0	0
Opposite opening	OP		0	0	0	0	0	0
Lock	LC		0	-	0	-	0	-
Castors	C		0	0	0	0	0	0
Remote group	RG		0	0	0	0	0	0
Back in Stainless Steel	BS		0	0	0	0	0	0
Frame heater	FH		0	0	0	0	•	•
Pedal	PD		0	-	0	-	0	-

Standard Accessories

CODE	DESCRIPTION	11G	12G	€
19097787	GN 2/1 epoxy grid pc	3	3	-

Other Accessories

CODE	DESCRIPTION	€
19048712	Meat bar GN uprights single body	-

CONCEPT

GN 2/1 1400

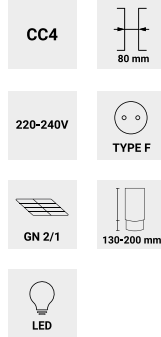

General characteristics

- Interior constructed with AISI-304 stainless steel exterior in food grade stainless steel.
- Embedded inner guides with 23 different level position 55 mm distance among them, enable more convenient cleaning operations without difficulties.
- Removable and height adjustable epoxy coated GN 2/1 grids with a maximum loading capacity of up to 40 kg.



MODEL	DIMENSIONS (MM)	VOLUME (L)	TEMPERATURE (°C)	DEFROST	GAS	COOLING POWER (KW)	ELECTRIC POWER (KW)	ANNUAL CONSUMPTION (KWH)	ENERGY EFFICIENCY CLASS	FREQUENCY	REFERENCE	€
◎ STOCK CUP-22G	1.318 x 842 x 2.040	1.186	0 +8 °C	Stop	R-600a	0,436 (1)	0,206	C	913 (4)	50 Hz	19089448	-
					R-600a	0,437 (1)	0,223	-	-	60 Hz	19089449	-
CUP-23G	1.318 x 842 x 2.040	1.186	0 +8 °C	Stop	R-600a	0,436 (1)	0,206	C	913 (4)	50 Hz	19089450	-
					R-600a	0,437 (1)	0,223	-	-	60 Hz	19089451	-
CUP-24G	1.318 x 842 x 2.040	1.186	0 +8 °C	Stop	R-600a	0,436 (1)	0,206	C	913 (4)	50 Hz	19089452	-
					R-600a	0,437 (1)	0,223	-	-	60 Hz	19089453	-
CUPT-22G	1.318 x 842 x 2.040	1.186	-2 +8 °C	Electric	R-600a	0,436 (1)	0,736	C	944 (4)	50 Hz	19103265	-
					R-600a	0,437 (1)	0,752	-	-	60 Hz	19110991	-
CUPT-23G	1.318 x 842 x 2.040	1.186	-2 +8 °C	Electric	R-600a	0,436 (1)	0,736	C	944 (4)	50 Hz	19106055	-
					R-600a	0,437 (1)	0,752	-	-	60 Hz	19110992	-
CUPT-24G	1.318 x 842 x 2.040	1.186	-2 +8 °C	Electric	R-600a	0,436 (1)	0,736	C	944 (4)	50 Hz	19106056	-
					R-600a	0,437 (1)	0,752	-	-	60 Hz	19110996	-
◎ STOCK CUN-22G	1.318 x 842 x 2.040	1.186	-18 -22 °C	Hot gas (3)	R290	0,907 (2)	0,749	E	4.793 (4)	50 Hz	19089458	-
					R290	0,799 (2)	0,831	-	-	60 Hz	19089459	-
					R290	0,907 (2)	0,755	E	4.793 (4)	50 Hz	19089460	-
CUN-23G	1.318 x 842 x 2.040	1.186	-18 -22 °C	Hot gas (3)	R290	0,799 (2)	0,837	-	-	60 Hz	19089461	-
					R290	0,907 (2)	0,76	E	4.793 (4)	50 Hz	19089462	-
CUN-24G	1.318 x 842 x 2.040	1.186	-18 -22 °C	Hot gas (3)	R290	0,907 (2)	0,842	-	-	60 Hz	19089463	-
					R290	0,799 (2)	0,842	-	-	60 Hz	19089463	-

(1) Evap. -10°C/ Cond. 45°C (2) Evap. -25°C/ Cond. 45°C (3) Remote Group Electric (4) According to EN22041 standard

Options

			CUP-22G (€)	CUP-23G (€)	CUP-24G (€)	CUPT-22G (€)	CUPT-23G (€)	CUPT-24G (€)	CUN-22G (€)	CUN-23G (€)	CUN-24G (€)
G type plug	CI		0	0	0	0	0	0	0	0	0
Lock	LC		0	-	-	0	-	-	0	-	-
Castors	C		0	0	0	0	0	0	0	0	0
Remote group	RG		0	0	0	0	0	0	0	0	0
Back in Stainless Steel	BS		0	0	0	0	0	0	0	0	0
Frame heater	FH		0	0	0	0	0	0	•	•	•
Pedal	PD		0	-	-	0	-	-	0	-	-

Standard Accessories

CODE	DESCRIPTION		22G	23G	24G	€
19097787	GN 2/1 epoxy grid	pc	6	6	6	-
19014778	Tray support guides L=562mm	pc	3	3	3	-

Other Accessories

CODE	DESCRIPTION	€
19048713	Meat bar GN uprights double body	-

CONCEPT

GN 2/1 Display 700



CUP-11G GD

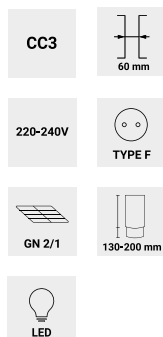

General characteristics

- Interior constructed with AISI-304 stainless steel exterior in food grade stainless steel.
- Embedded inner guides with 23 different level position 55 mm distance among them, enable more convenient cleaning operations without difficulties.
- Glass door:
 - Refrigeration: Double-glazed doors insulated with low thermal emissivity to reduce heat transfer in refrigeration.
 - Freezer and tropicalized uprights: Triple glazed door with electric heating system to avoid any kind of condensation in the doors.
- Removable and height adjustable epoxy coated GN 2/1 grids with a maximum loading capacity of up to 40 kg.



MODEL	DIMENSIONS (mm)	VOLUME (L)	TEMPERATURE (°C)	DEFROST	GAS	COOLING POWER (kW)	ELECTRIC POWER (kW)	ANNUAL CONSUMPTION (kWh)	ENERGY EFFICIENCY CLASS	FREQUENCY	REFERENCE	€
CUP-11G GD	653 x 842 x 2.040	610	0 +8 °C	Stop	R-600a	0,361 (1)	0,186	B	904 (5)	50 Hz	19089464	-
					R290	0,398 (1)	0,278	-	-	60 Hz	19089465	-
CUPT-11G GD	653 x 842 x 2.040	543	0 +8 °C	Electric	R-600a	0,361 (1)	0,793	B	1.305 (5)	50 Hz	19106095	-
					R290	0,398 (1)	0,885	-	-	60 Hz	19110998	-
CUN-11G GD	653 x 842 x 2.040	543	-18 -22 °C	Hot gas (3)	R290	0,535 (2)	0,58	F	5.906 (5)	50 Hz	19097604	-
					R290	0,72 (2)	0,496	-	-	60 Hz	19111002	-

(1) Evap. -10°C/ Cond. 45°C

(2) Evap. -25°C/ Cond. 45°C

(3) Remote Group Electric

(5) According to EN23953 standard

Options

		CUP-11G GD (€)	CUPT-11G GD (€)	CUN-11G GD (€)
G type plug	Cl	o	o	o
Opposite opening	OP	o	o	o
Lock	LC	●	●	●
Castors	C	o	o	o
Remote group	RG	o	o	o
Back in Stainless Steel	BS	o	o	o
Frame heater	FH	o	o	●
Pedal	PD	o	o	o
Glass door	GD	●	●	●

Standard Accessories

CODE	DESCRIPTION	11G	€
19097787	GN 2/1 epoxy grid	pc 3	-

Other Accessories





CODE	DESCRIPTION	€
19048712	Meat bar GN uprights single body	-

CONCEPT

GN 2/1 Display 1400



CUP-22G GD

- CC3** 
- 220-240V** 
- GN 2/1** 
- LED** 

General characteristics

- Interior constructed with AISI-304 stainless steel exterior in food grade stainless steel.
- Embedded inner guides with 23 different level position 55 mm distance among them, enable more convenient cleaning operations without difficulties.
- Glass door:
 - Refrigeration: Double-glazed doors insulated with low thermal emissivity to reduce heat transfer in refrigeration.
 - Freezer and tropicalized uprights: Triple glazed door with electric heating system to avoid any kind of condensation in the doors.
- Removable and height adjustable epoxy coated GN 2/1 grids with a maximum loading capacity of up to 40 kg.





MODEL	DIMENSIONS (mm)	VOLUME (L)	TEMPERATURE (°C)	DEFROST	GAS	COOLING POWER (kW)	ELECTRIC POWER (kW)	ANNUAL CONSUMPTION (kWh)	ENERGY EFFICIENCY CLASS	FREQUENCY	REFERENCE	€
CUP-22G GD	1.318 x 842 x 2.040	1.332	0 +8 °C	Stop	R-600a	0,436 (1)	0,212	B	1.369 (5)	50 Hz	19089468	-
					R-600a	0,437 (1)	0,229	-	-	60 Hz	19089469	-
CUPT-22G GD	1.318 x 842 x 2.040	1.186	0 +8 °C	Electric	R-600a	0,436 (1)	0,896	B	1.679 (5)	50 Hz	19106098	-
					R-600a	0,437 (1)	0,912	-	-	60 Hz	19110997	-
CUN-22G GD	1.318 x 842 x 2.040	1.186	-18 -22 °C	Hot gas (3)	R290	0,907 (2)	0,749	E	9.198 (5)	50 Hz	19099968	-
					R290	0,799 (2)	0,831	-	-	60 Hz	19111003	-

(1) Evap. -10°C/ Cond. 45°C (2) Evap. -25°C/ Cond. 45°C (3) Remote Group Electric (5) According to EN23953 standard

Options

		CUP-22G GD (€)	CUPT-22G GD (€)	CUN-22G GD (€)
G type plug	CI 	o	o	o
Lock	LC	●	●	●
Castors	C	o	o	o
Remote group	RG	o	o	o
Back in Stainless Steel	BS	o	o	o
Frame heater	FH	o	o	●
Pedal	PD	o	o	o
Glass door	GD	●	●	●

Standard Accessories

CODE	DESCRIPTION	22G	€
 19097787	GN 2/1 epoxy grid	pc	6 -
 19014778	Tray support guides L=562mm	pc	3 -

Other Accessories

CODE	DESCRIPTION	€
 19048713	Meat bar GN uprights double body	-

CONCEPT

GN 2/1 700 with Freezing Compartment



CUD-22G/M

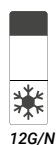

12G/N



22G/M

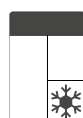

23G/N

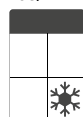

24G/N

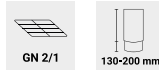

General characteristics

- Interior constructed with AISI-304 stainless steel exterior in food grade stainless steel.
- CUD-22G/M:
 - 60 mm insulation, embedded and inner guides independent modules with their respective refrigeration units and electronic controls.
 - Equipped with removable and height adjustable epoxy coated 3 x GN 2/1 grids with a maximum loading capacity of up to 40 kg.
- CUD-XXG/N:
 - 50 mm insulation, with zipper and removable guiding rails system.
 - Refrigeration compartment equipped with GN2/1 guides.
 - Freezer compartment equipped with 3 PVC 530X540 sanitary baskets.



22G/M



XXG/N

MODEL	DIMENSIONS (mm)	VOLUME (L)	COMPARTMENT	TEMPERATURE (°C)	DEFROST	GAS	COOLING POWER (kW)	ELECTRIC POWER (kW)	FREQUENCY	REFERENCE	€
CUD-22G/M	1.318 x 842 x 2.040	1.220	+ / -	0 +8 °C / -18° -22°	Stop / Electric	R-600a	0,361 (1)	0,654	50 Hz	19089470	-
						R290	0,398 (2)	0,771	60 Hz	19089471	-
CUD-12G/N	693 x 826 x 2.008	596	+ / -	0 +8 °C / -18° -22°	Stop / Electric	R290	0,369 (1)	0,741	50 Hz	19089472	-
						R290	0,398 (2)	0,828	60 Hz	19089473	-
CUD-23G/N	1.388 x 826 x 2.008	1.301	+ / -	0 +8 °C / -18° -22°	Stop / Electric	R-600a	0,436 (1)	0,658	50 Hz	19089474	-
						R-600a	0,437 (2)	0,717	60 Hz	19089475	-
CUD-24G/N	1.388 x 826 x 2.008	1.301	+ / -	0 +8 °C / -18° -22°	Stop / Electric	R-600a	0,436 (1)	0,658	50 Hz	19089476	-
						R-600a	0,437 (2)	0,717	60 Hz	19089477	-

(1) Evap. -10°C/ Cond. 45°C (2) Evap. -25°C/ Cond. 45°C

Options

			CUD-22G/M (€)	CUD-12G/N (€)	CUD-23G/N (€)	CUD-24G/N (€)
G type plug	CI		0	0	0	0
Opposite opening	OP		-	0	-	-
Lock	LC		0	-	-	-
Castors	C		0	0	0	0
Back in Stainless Steel	BS		0	0	0	0
Frame heater	FH		0	0	0	0
Pedal	PD		0	-	-	-

Standard Accessories

CODE	DESCRIPTION		22G/M	12G/N	23G/N	24G/N	€
19097787	GN 2/1 epoxy grid	pc	6	1	4	4	-
19010206	Tray support guides L=662 mm	pc	-	4	7	7	-
19097770	530x540x100 plastic tray	pc	-	3	3	3	-

CONCEPT

GN 2/1 1400 with Fish Compartment



CUD-12G/F

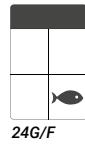
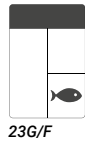

CC4	
220-240V	TYPE F
GN 2/1	EN 60x40
130-200 mm	LED

General characteristics

- Interior constructed with AISI-304 stainless steel exterior in food grade stainless steel.
- Refrigeration compartment:
 - Removable guiding rails construction with 18 grid level position per each full door with 70 mm distance among them.
 - Height adjustable epoxy coated GN 2/1 grids with a maximum loading capacity of up to 40 kg.
- Fish compartment:
 - Equipped with 3 sanitary PVC baskets 530x540.



MODEL	DIMENSIONS (mm)	VOLUME (L)	COMPARTMENT	TEMPERATURE (°C)	DEFROST	GAS	COOLING POWER (kW)	ELECTRIC POWER (kW)	FREQUENCY	REFERENCE	€
CUD-12G/F	693 x 826 x 2.008	596	+ / F	0 +8 °C / -2 -4 °C	Stop / Electric	R290	0,369 (1)	0,954	50 Hz	19089478	-
						R290	0,398 (2)	1,046	60 Hz	19090329	-
CUD-23G/F	1.388 x 826 x 2.008	1.301	+ / F	0 +8 °C / -2 -4 °C	Stop / Electric	R-600a	0,436 (1)	0,852	50 Hz	19089479	-
						R-600a	0,437 (2)	0,915	60 Hz	19090330	-
CUD-24G/F	1.388 x 826 x 2.008	1.301	+ / F	0 +8 °C / -2 -4 °C	Stop / Electric	R-600a	0,436 (1)	0,852	50 Hz	19089480	-
						R-600a	0,437 (2)	0,915	60 Hz	19090331	-

(1) Evap. -10°C/ Cond. 45°C (2) Evap. -25°C/ Cond. 45°C

Options

		CUD-12G (€)	CUD-23G/F (€)	CUD-24G/F (€)
G type plug	Cl	o	o	o
Opposite opening	OP	o	-	-
Castors	C	o	o	o
Back in Stainless Steel	BS	o	o	o
Frame heater	FH	o	o	o

Standard Accessories

CODE	DESCRIPTION		12G/F	23G/F	24G/F	€
19097787	GN 2/1 epoxy grid	pc	1	4	4	-
19010206	Tray support guides L=662 mm	pc	2	4	4	-
19097759	530x460x100 plastic tray	pc	3	3	3	-
19097774	SS perforated bottom	pc	3	3	3	-
19010200	Tray support guides L=613mm	pc	3	3	3	-

CONCEPT

GN 2/1 Dual Temperature



CUD-22G/2

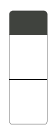

12G/2

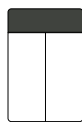

22G/2

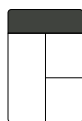

23G/2

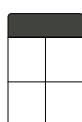

24G/2

CC4



50 mm

220-240V



TYPE F

GN 2/1



130-200 mm

LED



General characteristics

- Interior constructed with AISI-304 stainless steel exterior in food grade stainless steel.
- Removable guiding rails construction with 18 grid level position per each full door with 70 mm distance among them.
- Removable and height adjustable epoxy coated GN 2/1 grids with a maximum loading capacity of up to 40 kg.



MODEL	DIMENSIONS (mm)	VOLUME (L)	COMPARTMENT	TEMPERATURE (°C)	DEFROST	GAS	COOLING POWER (kW)	ELECTRIC POWER (kW)	FREQUENCY	REFERENCE	€
CUD-12G/2	693 x 826 x 2.008	596	+ / +	0 +8 °C	Stop	R290	0,369 (1)	0,616	50 Hz	19089481	-
						R290	0,398 (1)	0,708	60 Hz	19090332	-
CUD-22G/2	1.388 x 826 x 2.008	1.301	+ / +	0 +8 °C	Stop	R-600a	0,361 (1)	0,367	50 Hz	19089482	-
						R290	0,398 (1)	0,55	60 Hz	19090333	-
CUD-23G/2	1.388 x 826 x 2.008	1.301	+ / +	0 +8 °C	Stop	R-600a	0,361 (1)	0,367	50 Hz	19089483	-
						R290	0,398 (1)	0,55	60 Hz	19090334	-
CUD-24G/2	1.388 x 826 x 2.008	1.301	+ / +	0 +8 °C	Stop	R-600a	0,361 (1)	0,367	50 Hz	19089484	-
						R290	0,398 (1)	0,55	60 Hz	19090335	-

(1) Evap. -10°C/ Cond. 45°C (2) Evap. -25°C/ Cond. 45°C (4) According to EN22041 standard

Options

			CUD-12G/2 (€)	CUD-22G/2 (€)	CUD-23G/2 (€)	CUD-24G/2 (€)
G type plug	CI		0	0	0	0
Opposite opening	OP		0	-	-	-
Lock	LC		-	0	-	-
Castors	C		0	0	0	0
Back in Stainless Steel	BS		0	0	0	0
Frame heater	FH		0	0	0	0
Pedal	PD		-	0	-	-

Standard Accessories

CODE	DESCRIPTION		12G/2	22G/2	23G/2	24G/2	€
19097787	GN 2/1 epoxy grid	pc	2	6	6	6	-
19010206	Tray support guides L=662 mm	pc	2	6	6	6	-

CONCEPT

GN 1/1 400



CUP-11G1/1

CUP-11G1/1 GD

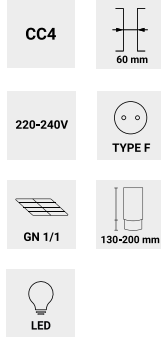

General characteristics

- Interior constructed with AISI-304 stainless steel exterior in food grade stainless steel.
- Removable guiding rails construction with 18 grid level position per each full door with 70 mm distance among them.
- Removable and height adjustable epoxy coated GN 1/1 grids with a maximum loading capacity of up to 40 kg.

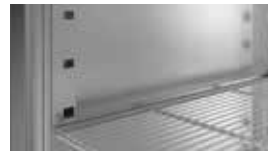

MODEL	DIMENSIONS (mm)	VOLUME (L)	TEMPERATURE (°C)	DEFROST	GAS	COOLING POWER (kW)	ELECTRIC POWER (kW)	ANNUAL CONSUMPTION (kWh)	ENERGY EFFICIENCY CLASS	FREQUENCY	REFERENCE	€
CUP-11G1/1	490 x 700 x 2.010	305	0 +8 °C	Stop	R-600a	0,361 (1)	0,205	D	726 (4)	50 Hz	19089485	-
					R290	0,398 (1)	0,297	-	-	60 Hz	19089486	-
CUP-11G1/1 GD	490 x 700 x 2.010	305	0 +8 °C	Stop	R-600a	0,361 (1)	0,208	B	983 (5)	50 Hz	19089487	-
					R290	0,398 (1)	0,3	-	-	60 Hz	19089488	-
CUN-11G1/1	490 x 700 x 2.010	305	-18 -22 °C	Electric	R290	0,364 (2)	0,369	E	2.197 (4)	50 Hz	19089489	-
					R290	0,381 (2)	0,41	-	-	60 Hz	19089490	-

(1) Evap. -10°C/ Cond. 45°C

(2) Evap. -25°C/ Cond. 45°C

(4) According to EN22041 standard

(5) According to EN23953 standard

Options

		CUP-11G1/1 (€)	CUP-11G1/1 GD (€)	CUN-11G1/1 (€)
G type plug	Cl	o	o	o
Opposite opening	OP	o	o	o
Lock	LC	o	●	o
Castors	C	o	o	o
Remote group	RG	o	o	o
Back in Stainless Steel	BS	o	o	o
Frame heater	FH	o	o	●
Glass Door	GD	-	●	-





Standard Accessories

	CODE	DESCRIPTION		11G1/1	€
	19097778	GN 2/1 epoxy grid	pc	3	-
	19100845	Tray support guides L=532 mm	pc	3	-

Snack 600



CUP-11S

- CC4**  50 mm
- 220-240V**  TYPE F
- 560x542**  130-200 mm
- LED** 

General characteristics

- Interior and exterior built-in with food grade stainless steel for intensive professional applications.
- Constructed with a rail system placed in the front and back of the upright with 18 grid level position and 70 mm distance among them.
- Removable and height adjustable epoxy coated 560x542 size grids with a maximum loading capacity of up to 40 kg.



	MODEL	DIMENSIONS (mm)	VOLUME (L)	TEMPERATURE (°C)	DEFROST	GAS	COOLING POWER (kW)	ELECTRIC POWER (kW)	ANNUAL CONSUMPTION (kWh)	ENERGY EFFICIENCY CLASS	FREQUENCY	REFERENCE	€
STOCK	CUP-11S	693 x 726 x 2.067	506	0 +8 °C	Stop	R-600a	0,361 (1)	0,183	C	548 (4)	50 Hz	19089491	-
						R290	0,398 (1)	0,275	-	-	60 Hz	19089492	-
	CUP-12S	693 x 726 x 2.067	506	0 +8 °C	Stop	R-600a	0,361 (1)	0,183	C	548 (4)	50 Hz	19089493	-
						R290	0,398 (1)	0,275	-	-	60 Hz	19089494	-
STOCK	CUN-11S	693 x 726 x 2.067	506	-18 -22 °C	Electric	R290	0,364 (2)	0,35	E	2.778 (4)	50 Hz	19089505	-
						R290	0,381 (2)	0,391	-	-	60 Hz	19089506	-
	CUN-12S	693 x 726 x 2.067	506	-18 -22 °C	Electric	R290	0,364 (2)	0,356	E	2.778 (4)	50 Hz	19089507	-
						R290	0,381 (2)	0,397	-	-	60 Hz	19089508	-

(1) Evap. -10°C/ Cond. 45°C (2) Evap. -25°C/ Cond. 45°C (4) According to EN22041 standard

Options

			CUP-11S (€)	CUP-12S (€)	CUN-11S (€)	CUN-12S (€)
G type plug	CI		0	0	0	0
Opposite opening	OP		0	0	0	0
Lock	LC		0	-	0	-
Castors	C		0	0	0	0
Remote group	RG		0	0	0	0
Back in Stainless Steel	BS		0	0	0	0
Frame heater	FH		0	0	●	●

Standard Accessories

CODE	DESCRIPTION	11S	12S	€
 19097772	560x542 epoxy grid	pc	3 3	-

Other Accessories

CODE	DESCRIPTION	€
 19048715	Meat bar snack uprights	-

Snack 1200



CUP-22S

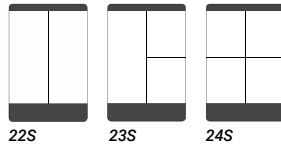

- CC4**
- 220-240V**
- 560x542**
- 130-200 mm**
- 500x154**
- TYPE F**
- LED**

General characteristics

- Interior and exterior built-in with food grade stainless steel for intensive professional applications.
- Constructed with a rail system placed in the front and back of the upright with 18 grid level position and 70 mm distance among them.
- Removable and height adjustable epoxy coated 560x542 size grids with a maximum loading capacity of up to 40 kg.



	MODEL	DIMENSIONS (MM)	VOLUME (L)	TEMPERATURE (°C)	DEFROST	GAS	COOLING POWER (KW)	ELECTRIC POWER (KW)	ANNUAL CONSUMPTION (KWH)	ENERGY EFFICIENCY CLASS	FREQUENCY	REFERENCE	€
STOCK	CUP-22S	1.388 x 726 x 2.067	1.109	0 +8 °C	Stop	R-600a	0,436 (1)	0,206	C	975 (4)	50 Hz	19089495	-
						R-600a	0,437 (1)	0,223	-	-	60 Hz	19089496	-
	CUP-23S	1.388 x 726 x 2.067	1.109	0 +8 °C	Stop	R-600a	0,436 (1)	0,206	C	975 (4)	50 Hz	19089497	-
						R-600a	0,437 (1)	0,223	-	-	60 Hz	19089498	-
STOCK	CUP-24S	1.388 x 726 x 2.067	1.109	0 +8 °C	Stop	R-600a	0,436 (1)	0,206	C	975 (4)	50 Hz	19089499	-
						R-600a	0,437 (1)	0,223	-	-	60 Hz	19089500	-
	CUN-22S	1.388 x 726 x 2.067	1.109	-18 -22 °C	Electric	R290	0,735 (2)	0,601	E	4.855 (4)	50 Hz	19089509	-
						R290	0,802 (2)	0,657	-	-	60 Hz	19089510	-
STOCK	CUN-23S	1.388 x 726 x 2.067	1.109	-18 -22 °C	Electric	R290	0,735 (2)	0,607	E	4.855 (4)	50 Hz	19089511	-
						R290	0,802 (2)	0,663	-	-	60 Hz	19089512	-
	CUN-24S	1.388 x 726 x 2.067	1.109	-18 -22 °C	Electric	R290	0,735 (2)	0,613	E	4.855 (4)	50 Hz	19089513	-
						R290	0,802 (2)	0,669	-	-	60 Hz	19089514	-

(1) Evap. -10°C/ Cond. 45°C (2) Evap. -25°C/ Cond. 45°C (4) According to EN22041 standard

Options

			CUP-22S (€)	CUP-23S (€)	CUP-24S (€)	CUN-22S (€)	CUN-23S (€)	CUN-24S (€)
G type plug	Cl		0	0	0	0	0	0
Lock	LC		0	-	-	0	-	-
Castors	C		0	0	0	0	0	0
Remote group	RG		0	0	0	0	0	0
Back in Stainless Steel	BS		0	0	0	0	0	0
Frame heater	FH		0	0	0	●	●	●

Standard Accessories

CODE	DESCRIPTION	22S	23S	24S	€
19097772	560x542 epoxy grid	pc 6	6	6	-
19097785	500x154 epoxy grid	pc 3	3	3	-

Other Accessories

CODE	DESCRIPTION	€
19048715	Meat bar snack uprights	-

Snack Display



CUP-22S GD

CUP-11S GD

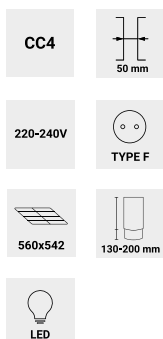

General characteristics

- Interior and exterior built-in with food grade stainless steel for intensive professional applications.
- Constructed with a rail system placed in the front and back of the upright with 18 grid level position and 70 mm distance among them.
- Double-glazed doors insulated with low thermal emissivity to reduce heat transfer in refrigeration.
- Removable and height adjustable epoxy coated 560x542 size grids with a maximum loading capacity of up to 40 kg.



MODEL	DIMENSIONS (mm)	VOLUME (L)	TEMPERATURE (°C)	DEFROST	GAS	COOLING POWER (kW)	ELECTRIC POWER (kW)	ANNUAL CONSUMPTION (kWh)	ENERGY EFFICIENCY CLASS	FREQUENCY	REFERENCE	€
CUP-11S GD	693 x 726 x 2.067	506	0 +8 °C	Stop	R-600a	0,361 (1)	0,186	B	904 (5)	50 Hz	19089501	-
					R290	0,398 (1)	0,278	-	-	60 Hz	19089502	-
CUP-22S GD	1.388 x 726 x 2.067	1.109	0 +8 °C	Stop	R-600a	0,436 (1)	0,212	B	1.609 (5)	50 Hz	19089503	-
					R-600a	0,437 (1)	0,229	-	-	60 Hz	19089504	-

(1) Evap. -10°C/ Cond. 45°C (2) Evap. -25°C/ Cond. 45°C (5) According to EN23953 standard

Options

		CUP-11S GD (€)	CUP-12S GD (€)
G type plug	CI	0	0
Opposite opening	OP	0	-
Lock	LC	●	●
Castors	C	0	0
Remote group	RG	0	0
Back in Stainless Steel	BS	0	0
Frame heater	FH	0	0
Glass door	GD	●	●

Standard Accessories

CODE	DESCRIPTION	11S	22S	€
19097772	560x542 epoxy grid	pc 3	6	-
19097785	500x154 epoxy grid	pc -	3	-

Other Accessories

CODE	DESCRIPTION	€
19048715	Meat bar snack uprights	-

Snack with Freezing Compartment



CUD-12S/N

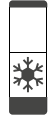

12S/N



22S/M

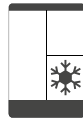

23S/N

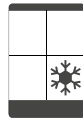

24S/N

CC4



220-240V



560x542
530x540



General characteristics

- Interior and exterior built-in with food grade stainless steel for intensive professional applications.
- Constructed with a rail system placed in the front and back of the upright with 18 grid level position and 70mm distance among them.
- CUD-22S/M:
 - Equipped with 3 560x542 grid per each full door with a maximum loading capacity of up to 40 kg.
- CUD-XXS/N:
 - Refrigeration chamber equipped with 3x 560x542 grid per full door compartment and 1 piece in half door compartment.
 - Freezer compartment equipped with 3x PVC 530X540 sanitary baskets.

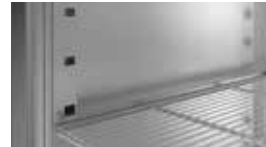

MODEL	DIMENSIONS (mm)	VOLUME (L)	COMPARTMENT	TEMPERATURE (°C)	DEFROST	GAS	COOLING POWER (kW)	ELECTRIC POWER (kW)	FREQUENCY	REFERENCE	€
CUD-22S/M	1.388 x 726 x 2.067	1.012	+ / -	0 +8 °C / -18 -22 °C	Stop / Electric	R-600a	0,361 (1)	0,533	50 Hz	19089515	-
						R290	0,398 (2)	0,666	60 Hz	19089516	-
CUD-12S/N	693 x 726 x 2.067	506	+ / -	0 +8 °C / -18 -22 °C	Stop / Electric	R290	0,369 (1)	0,581	50 Hz	19089517	-
						R290	0,398 (2)	0,668	60 Hz	19089518	-
CUD-23S/N	1.388 x 726 x 2.067	1.109	+ / -	0 +8 °C / -18 -22 °C	Stop / Electric	R-600a	0,436 (1)	0,578	50 Hz	19089519	-
						R-600a	0,437 (2)	0,637	60 Hz	19089520	-
CUD-24S/N	1.388 x 726 x 2.067	1.109	+ / -	0 +8 °C / -18 -22 °C	Stop / Electric	R-600a	0,436 (1)	0,578	50 Hz	19089521	-
						R-600a	0,437 (2)	0,637	60 Hz	19089522	-

(1) Evap. -10°C/ Cond. 45°C (2) Evap. -25°C/ Cond. 45°C

Options

			CUD-22S/M (€)	CUD-12S/N (€)	CUD-23S/N (€)	CUD-24S/N (€)
G type plug	CI		0	0	0	0
Opposite opening	OP		-	0	-	-
Lock	LC		0	-	-	-
Castors	C		0	0	0	0
Back in Stainless Steel	BS		0	0	0	0
Frame heater	FH		0	0	0	0

Standard Accessories

CODE	DESCRIPTION		22S/M	12S/N	23S/N	24S/N	€
19097772	560x542 epoxy grid	pc	6	1	4	4	-
19097785	500x154 epoxy grid	pc	-	-	1	1	-
19014778	Tray support guides L=562 mm	pc	-	3	3	3	-

Snack with Fish Compartment



CUD-12S/F



12S/F

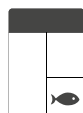

23S/F

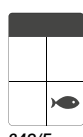

24S/F

CC4



50 mm

220-240V



TYPE F

560x542
530x540

130-200 mm

LED



General characteristics

- Interior and exterior built-in with food grade stainless steel for intensive professional applications.
- Constructed with a rail system placed in the front and back of the upright with 18 grid level position and 70 mm distance among them.
- Refrigeration chamber equipped with 3x 560x542 grid per each full door and 1 per each half door.
- Fish compartment equipped with 3x PVC 530X540 sanitary baskets.



MODEL	DIMENSIONS (mm)	VOLUME (L)	COMPARTMENT	TEMPERATURE (°C)	DEFROST	GAS	COOLING POWER (kW)	ELECTRIC POWER (kW)	FREQUENCY	REFERENCE	€
CUD-12S/F	693 x 726 x 2.067	506	+ / F	0 +8 °C / -2 -4 °C	Stop / Electric	R290	0,369 (1)	0,874	50 Hz	19089523	-
						R290	0,398 (2)	0,966	60 Hz	19090336	-
CUD-23S/F	1.388 x 726 x 2.067	1.109	+ / F	0 +8 °C / -2 -4 °C	Stop / Electric	R-600a	0,436 (1)	0,852	50 Hz	19089524	-
						R-600a	0,437 (2)	0,915	60 Hz	19090337	-
CUD-24S/F	1.388 x 726 x 2.067	1.109	+ / F	0 +8 °C / -2 -4 °C	Stop / Electric	R-600a	0,436 (1)	0,852	50 Hz	19089525	-
						R-600a	0,437 (2)	0,915	60 Hz	19090338	-

(1) Evap. -10°C/ Cond. 45°C (2) Evap. -25°C/ Cond. 45°C

Options

			CUD-12S/F (€)	CUD-23S/F (€)	CUD-24S/F (€)
G type plug	CI		0	0	0
Opposite opening	OP		0	-	-
Castors	C		0	0	0
Back in Stainless Steel	BS		0	0	0
Frame heater	FH		0	0	0







Standard Accessories

	CODE	DESCRIPTION		12S/F	23S/F	24S/F	€
	19097772	560x542 epoxy grid	pc	1	4	4	-
	19097785	500x154 epoxy grid	pc	-	1	1	-
	19097759	530x460x100 plastic tray	pc	3	3	3	-
	19097773	SS perforated bottom	pc	3	3	3	-
	19015961	Tray support guides L=519mm	pc	3	3	3	-

Pastry EN60x40



CUP-11B

-  CC4
-  50 mm
-  220-240V
-  TYPE F
-  EN 60x40
-  130-200 mm
-  LED

General characteristics

- Interior and exterior built-in with food grade stainless steel for intensive professional applications.
- Constructed with a rail system placed in the front and back of the upright with 20 grid level position and 60 mm distance among them.
- Removable and height adjustable epoxy coated EN 60x40 size grids with a maximum loading capacity of up to 40 kg.





MODEL	DIMENSIONS (MM)	VOLUME (L)	TEMPERATURE (°C)	DEFROST	GAS	COOLING POWER (KW)	ELECTRIC POWER (KW)	ANNUAL CONSUMPTION (KWH)	ENERGY EFFICIENCY CLASS	FREQUENCY	REFERENCE	€
CUP-11B	760 x 729 x 2.006	574	0 +8 °C	Stop	R290	0,369 (1)	0,251	E	927 (4)	50 Hz	19089526	-
					R290	0,398 (1)	0,297	-	-	60 Hz	19090339	-
CUN-11B	760 x 729 x 2.006	574	-18 -22 °C	Electric	R290	0,364 (2)	0,348	D	2.716 (4)	50 Hz	19106057	-
					R290	0,381 (2)	0,369	-	-	60 Hz	19111011	-

(1) Evap. -10°C/ Cond. 45°C (2) Evap. -25°C/ Cond. 45°C (4) According to EN22041 standard

Options

			CUP-11B (€)	CUN-11B (€)
G type plug	CI		o	o
Opposite opening	OP		o	o
Lock	LC		o	o
Castors	C		o	o
Remote group	RG		o	o
Back in Stainless Steel	BS		o	o
Frame heater	FH		o	●
Pedal	PD		o	o

Standard Accessories

	CODE	DESCRIPTION		11B	€
	19097776	EN 60x40 epoxy grid	pc	3	-
	19033558	Tray support guides L=496mm	pc	3	-

Fish EN60x40



CU-11F

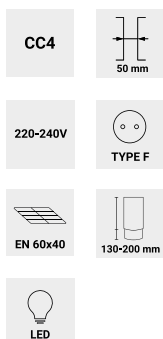

General characteristics

- Interior and exterior built-in with food grade stainless steel for intensive professional applications.
- Constructed with a rail system placed in the front and back of the upright with 20 grid level position and 60 mm distance among them.
- Removable and height adjustable 600x400x120 baskets with a maximum loading capacity of up to 40 Kg.



MODEL	DIMENSIONS (MM)	VOLUME (L)	TEMPERATURE	DEFROST	GAS	COOLING POWER (KW)	ELECTRIC POWER (KW)	FREQUENCY	REFERENCE	€
CU-11F	760 x 729 x 2.006	574	-2 -4 °C	Electric	R290	0,369 (2)	0,268	50 Hz	19089527	-
				Electric	R290	0,398 (2)	0,314	60 Hz	19090340	-

(1) Evap. -10°C/ Cond. 45°C



Options

			CU-11F (€)
G type plug	CI		o
Opposite opening	OP		o
Lock	LC		o
Castors	C		o
Remote group	RG		o
Back in Stainless Steel	BS		o
Frame heater	FH		o
Pedal	PD		o

Standard Accessories

	CODE	DESCRIPTION		11F	€
	19097771	Pastry tray 600x400x120	pc	7	-
	19097758	SS perforated bottom	pc	7	-
	19033558	Tray support guides L=496mm	pc	7	-

Accessories

MODEL	REFERENCE	DESCRIPTION	WHERE USED	€
Door orientation kit				
	KDO-1-L	19098278	Door orientation kit left	-
	KDO-1-R	19098279	Door orientation kit right	-
	KDO-2-L	19098300	Door orientation kit left	-
	KDO-2-R	19098301	Door orientation kit right	-
	KDO-3-L	19098302	Door orientation kit left	-
	KDO-3-R	19098303	Door orientation kit right	-
Castor kit				
	KC-4 Ø100	19015964	Kit 4 castors	-
	KC-6 Ø100	19046863	Kit 6 castors	-
Connectivity kit				
	19111437	Kit Fagor Konnect - Refrigeration	Advance uprights	-



Efficiency and quality
for professional needs.

Refrigerated counters

— Features.....	287
— Advance 700 GN 1/1	291
— Concept 700 GN 1/1	295
— Refrigerated bases	303
— Snack 600	307
— Pastry 800 EN60x40	313
— Accessories	314

Special units or any variations from the standard model must be assembled at the factory at an additional charge over the standard model's price.

Please, contact Fagor Professional for any other variation or option that is not included on this list.

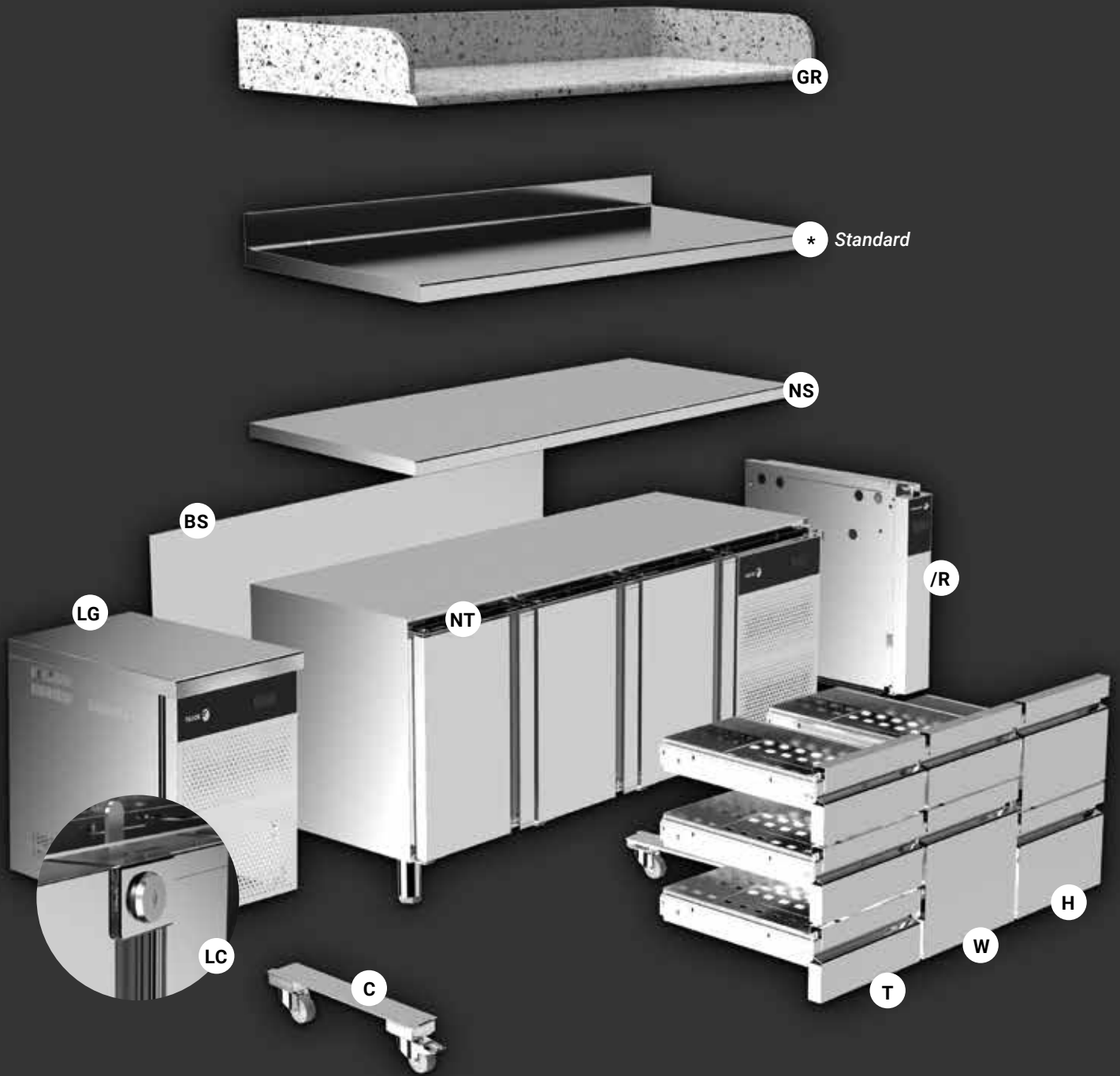

ABBREVIATION	DESCRIPTION
LG	Left group
NT	No top
NS	No splashback
T*	1/3 + 1/3 + 1/3 drawers
W*	2/3 + 1/3 drawers
H	1/2 + 1/2 drawers

ABBREVIATION	DESCRIPTION
LC	Lock
/R	Remote group
GR	Granite top
C	Castors
BS	Back in Stainless Steel

* Not possible to place in the group side compartment (in Concept models).

Efficiency and quality for professional needs.



	ADVANCE	CONCEPT	SNACK CABINETS	PASTRY CABINETS
	ACP-3G	CCP-3G	CCP-3S	CCP-3B
Capacity (N° of shelves per door)	13	7	3	6
Size of shelves	GN 1/1	GN 1/1	405 x 460 x 2 + 405 x 525	EN 60x40
Energy class	A	C	C	D
Insulation (mm)	60 + 30	50	50	50
Refrigerant + / -	R600a/R290	R600a/R290	R600a/R290	R290
Climate class (1 door)	5	4	4	4
Multiflow	Yes	No	No	No
HACCP compliant	Yes	No	No	No
Electronic control	Capacitive 5"	Capacitive 3"	Capacitive 3"	Capacitive 3"

Interface





Characteristics

Electronic control Easy to use

Functional and intuitive electronic control with capacitive keyboard that allows direct access to main functions.



ECO function

Function that optimizes the performance by automatically setting temperatures, when doors are not opened so that the cooling unit works only when needed and always, efficiently.



Climatic Class 5

Devices tested in harshest working environments, which ensure product preservation in high temperature and humidity conditions.

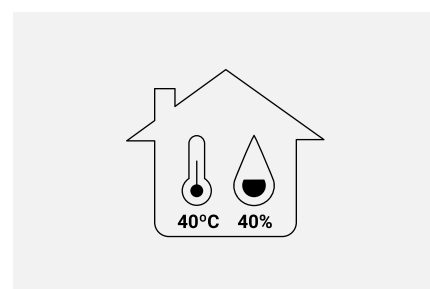

Front breathing

The front condensation ventilation system allows the installation of equipment, without compromising performance, in such a way that it enables the correct preservation of food in the most demanding work areas.



Removable door gasket

Removable triple camera pull-out/push-in magnetic door gasket to keep maximum hygiene and maintain the insulating properties.



Integrated handles

Stainless steel doors with ergonomic, full-length, robust, perfectly integrated handle. that ensures practical opening of the drawers and avoids dust and dirt collection.



Guide and zippers system

Removable Stainless steel rack and guide system without use of tools which allows a proper distribution of products.



Telescopic sliding drawers

Stainless steel drawers with perforated bottom plates and telescopic sliding guides, capable of complete retraction, to economize working surface.



Maximum stability

Height-adjustable stainless steel legs as standard. Height of the legs can be adjusted individually. In addition, there is also the option to choose swivel wheels or legs for marine.

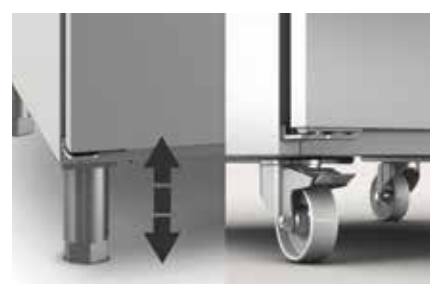

Optimal refrigeration circuit

Internally designed forced draft cooling system with low consumption electronic components to guarantee optimal equipment efficiency and performance.



Multiflow

Optimal air circulation system that guarantees a balanced and constant distribution throughout the equipment, so that the temperature remains uniform. It helps preserve food for longer.



Door Lock

Option to equip the refrigerated counters with a door lock. Standard feature in all display counters.



Automatic closing door

Hinged doors with automatic return for a perfect closing that minimize temperature gain. Doors have a 120° dwell position and close automatically at less than 90°.



Higher insulation thicknesses

Insulation thickness is a key factor in preventing losing cold. The new iKOLD generation increases the insulation levels of all mid ranges to provide greater cooling efficiency.



Pivotable panel

Pivotable panel with better access to control that facilitates service, thus enlarging the useful life of the equipment.



Connectivity

Guarantee the correct conservation of stored food through precise monitoring of your refrigeration equipment thanks to Fagor Konnect.



ADVANCE

700 GN 1/1



ACP-3G

CC5

HACCP

220-240V

TYPE F

GN 1/1

60 mm

130-200 mm



2G



3G

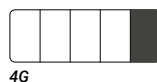

4G

General characteristics

- Interior and exterior completely manufactured in AISI-304 stainless steel.
- 30 mm stainless steel built in and polyurethane insulated working top with 100 mm high splash-back, preventing spillage behind the counter.
- 10 HACCP alarms capacity which are store when high temperature variation and devices power failure.
- Removable and height adjustable epoxy coated GN 1/1 grids with a maximum loading capacity of up to 40 kg.



	MODEL	DIMENSIONS (MM)	VOLUME (L)	TEMPERATURE (°C)	DEFROST	GAS	COOLING POWER (KW)	ELECTRIC POWER (KW)	ENERGY EFFICIENCY CLASS	ANNUAL CONSUMPTION (KWH)	FREQUENCY	REFERENCE	€
STOCK	ACP-2G	1.340 x 700 x 850	302	0 +8 °C	Stop	R-600a	0,36 (1)	0,16	A	423 (4)	50 Hz	19089528	-
						R-600a	0,36 (1)	0,17	-	-	60 Hz	19090341	-
STOCK	ACP-3G	1.790 x 700 x 850	446	0 +8 °C	Stop	R-600a	0,36 (1)	0,16	A	453 (4)	50 Hz	19089529	-
						R-600a	0,36 (1)	0,17	-	-	60 Hz	19090342	-
	ACP-4G	2.240 x 700 x 850	590	0 +8 °C	Stop	R-600a	0,36 (1)	0,16	A	584 (4)	50 Hz	19089530	-
						R-600a	0,36 (1)	0,17	-	-	60 Hz	19090343	-
	ACN-2G	1.340 x 700 x 850	302	-18 -22 °C	Hot gas (3)	R290	0,364 (2)	0,307	D	2.026 (4)	50 Hz	19089531	-
						R290	0,326 (2)	0,699	-	-	60 Hz	19089532	-
	ACN-3G	1.790 x 700 x 850	446	-18 -22 °C	Hot gas (3)	R290	0,364 (2)	0,316	D	2.662 (4)	50 Hz	19089533	-
						R290	0,326 (2)	0,708	-	-	60 Hz	19089534	-
	ACN-4G	2.240 x 700 x 850	590	-18 -22 °C	Hot gas (3)	R290	0,364 (2)	0,325	D	2.989 (4)	50 Hz	19089055	-
						R290	0,364 (2)	0,325	-	-	60 Hz	19096650	-

(1) Evap. -10°C/ Cond. 45°C

(2) Evap. -25°C/ Cond. 45°C

(3) Remote Group Electric

(4) According to EN22041 standard

Options

		ACP-2G (€)	ACP-3G (€)	ACP-4G (€)	ACN-2G (€)	ACN-3G (€)	ACN-4G (€)
Connectivity	K	0	0	0	0	0	0
Panoramic opening	PO	0	0	0	0	0	0
Left group	LG	0	0	0	0	0	0
No top	NT	0	0	0	0	0	0
No splash-back	NS	0	0	0	0	0	0
1/2 + 1/2 Drawer	H	0	0	0	-	-	-
1/3 + 1/3 +1/3 Drawer	T	0	0	0	-	-	-
2/3 + 1/3 Drawer	W	0	0	0	-	-	-
G type plug	CI	0	0	0	0	0	0
Lock	LC	0	0	0	0	0	0
Remote group	RG	0	0	0	0	0	0
Granite top	GR	0	0	0	0	0	0
Castors	C	0	0	0	0	0	0
Back in Stainless Steel	BS	0	0	0	0	0	0
Frame heater	FH	0	0	0	●	●	●

Standard Accessories

	CODE	DESCRIPTION	2G	3G	4G	€	
	19097778	GN 1/1 epoxy grid	pc	2	3	4	-
	19015961	Tray support guides L=519 mm	pc	4	6	8	-

Other Accessories

	CODE	DESCRIPTION	€
	19096243	Kit drawers 1/2+1/2 GN	-
	19096245	Kit drawers 1/3+1/3+1/3 GN	-
	19096244	Kit drawers 1/3+2/3 GN	-

ADVANCE

700 GN 1/1 with drawers



ACP-3G HHD

CC5	HACCP
220-240V	TYPE F
GN 1/1	60 mm



130-200 mm

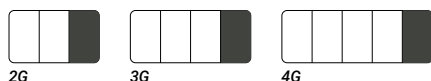

2G

3G

4G

General characteristics

- Interior and exterior completely manufactured in AISI-304 stainless steel.
- 30 mm stainless steel built in and polyurethane insulated flat working top without splashback.
- 10 HACCP alarms capacity which are store when high temperature variation and devices power failure.
- Removable and height adjustable epoxy coated GN 1/1 grids with a maximum loading capacity of up to 40 kg.



MODEL	DIMENSIONS (MM)	VOLUME (L)	TEMPERATURE (°C)	DEFROST	GAS	COOLING POWER (KW)	ELECTRIC POWER (KW)	ENERGY EFFICIENCY CLASS	ANNUAL CONSUMPTION (KWH)	FREQUENCY	REFERENCE	€
ACP-2G HD	1.340 x 700 x 850	302	0 +8 °C	Stop	R-600a	0,36 (1)	0,16	A	423 (4)	50 Hz	19089541	-
					R-600a	0,36 (1)	0,17	-	-	60 Hz	19090350	-
ACP-2G HH	1.340 x 700 x 850	302	0 +8 °C	Stop	R-600a	0,36 (1)	0,16	A	423 (4)	50 Hz	19089542	-
					R-600a	0,36 (1)	0,17	-	-	60 Hz	19090351	-
ACP-3G HDD	1.790 x 700 x 850	446	0 +8 °C	Stop	R-600a	0,36 (1)	0,16	A	453 (4)	50 Hz	19089543	-
					R-600a	0,36 (1)	0,17	-	-	60 Hz	19090352	-
ACP-3G HHD	1.790 x 700 x 850	446	0 +8 °C	Stop	R-600a	0,36 (1)	0,16	A	453 (4)	50 Hz	19089544	-
					R-600a	0,36 (1)	0,17	-	-	60 Hz	19090353	-
ACP-3G HHH	1.790 x 700 x 850	446	0 +8 °C	Stop	R-600a	0,36 (1)	0,16	A	453 (4)	50 Hz	19089545	-
					R-600a	0,36 (1)	0,17	-	-	60 Hz	19090354	-
ACP-4G HDDD	2.240 x 700 x 850	590	0 +8 °C	Stop	R-600a	0,36 (1)	0,16	A	584 (4)	50 Hz	19089546	-
					R-600a	0,36 (1)	0,17	-	-	60 Hz	19090355	-
ACP-4G HHDD	2.240 x 700 x 850	590	0 +8 °C	Stop	R-600a	0,36 (1)	0,16	A	584 (4)	50 Hz	19089547	-
					R-600a	0,36 (1)	0,17	-	-	60 Hz	19090356	-
ACP-4G HHHH	2.240 x 700 x 850	590	0 +8 °C	Stop	R-600a	0,36 (1)	0,16	A	584 (4)	50 Hz	19089548	-
					R-600a	0,36 (1)	0,17	-	-	60 Hz	19090357	-
ACP-4G HHHH	2.240 x 700 x 850	590	0 +8 °C	Stop	R-600a	0,36 (1)	0,16	A	584 (4)	50 Hz	19089549	-
					R-600a	0,36 (1)	0,17	-	-	60 Hz	19090358	-

(1) Evap. -10°C/ Cond. 45°C (2) Evap. -25°C/ Cond. 45°C (3) Remote Group Electric (4) According to EN22041 standard

Options

		ACP-2G HD (€)	ACP-2G HH (€)	ACP-3G HDD (€)	ACP-3G HHD (€)	ACP-3G HHH (€)	ACP-4G HDDD (€)	ACP-4G HHDD (€)	ACP-4G HHHH (€)	ACP-4G HHHH (€)
Connectivity	K	0	0	0	0	0	0	0	0	0
Panoramic Opening	PO	-	-	0	-	-	0	0	-	-
Left Group	LG	0	0	0	0	0	0	0	0	0
No Top	NT	0	0	0	0	0	0	0	0	0
No Splash-back	NS	0	0	0	0	0	0	0	0	0
G type plug	CI	0	0	0	0	0	0	0	0	0
Remote Group	RG	0	0	0	0	0	0	0	0	0
Granit Top	GR	0	0	0	0	0	0	0	0	0
Castors	C	0	0	0	0	0	0	0	0	0
Back in Steel	BS	0	0	0	0	0	0	0	0	0
Frame Heater	FH	0	0	0	0	0	0	0	0	0

ADVANCE

700 GN 1/1 Central



ACP-3G/C

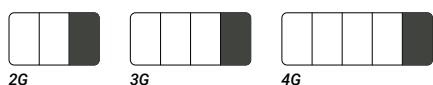

2G

3G

4G

CC5

HACCP

220-240V

TYPE F

GN 1/1

60 mm

130-200 mm

General characteristics





- Interior and exterior completely manufactured in AISI-304 stainless steel.
- 30 mm stainless steel built in and polyurethane insulated flat working top without splashback.
- Doors on both sides for enhance back and front access to the cooling chamber thus gaining flexibility at work.
- 10 HACCP alarms capacity wich are store when high temperature variation and devices power failure.
- Removable and height adjustable epoxy coated GN 1/1 grids with a maximum loading capacity of up to 40 kg.





MODEL	DIMENSIONS (MM)	VOLUME (L)	TEMPERATURE (°C)	DEFROST	GAS	COOLING POWER (KW)	ELECTRIC POWER (KW)	FREQUENCY	REFERENCE	€
ACP-2G/C	1.340 x 768 x 850	302	0 +8 °C	Stop	R-600a	0,36 (1)	0,16	50 Hz	19089538	-
					R-600a	0,36 (1)	0,17	60 Hz	19090347	-
ACP-3G/C	1.790 x 768 x 850	446	0 +8 °C	Stop	R-600a	0,36 (1)	0,16	50 Hz	19089539	-
					R-600a	0,36 (1)	0,17	60 Hz	19090348	-
ACP-4G/C	2.240 x 768 x 850	590	0 +8 °C	Stop	R-600a	0,36 (1)	0,16	50 Hz	19089540	-
					R-600a	0,36 (1)	0,17	60 Hz	19090349	-

(1) Evap. -10°C/ Cond. 45°C

Options

		ACP-2G/C (€)	ACP-3G/C (€)	ACP-4G/C (€)
Connectivity	K	o	o	o
Panoramic opening	PO	 o	o	o
No top	NT	 o	o	o
No splash-back	NS	 ●	●	●
G type plug	CI	 o	o	o
Lock	LC	o	o	o
Remote group	RG	o	o	o
Castors	C	o	o	o
Frame heater	FH	o	o	o

Standard Accessories

	CODE	DESCRIPTION	2G	3G	4G	€
	19097778	GN 1/1 epoxi grid	pc 2	3	4	-
	19010200	Tray support guides L=613 mm	pc 4	6	8	-

ADVANCE

700 GN 1/1 Display



ACP-3G GD

CC5	HACCP
220-240V	TYPE F
GN 1/1	60 mm
130-200 mm	

General characteristics



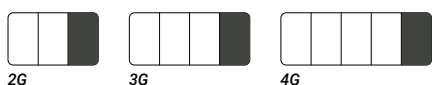

- Interior and exterior completely manufactured in AISI-304 stainless steel.
- 30 mm stainless steel built in and polyurethane insulated working top with 100 mm high splash-back, preventing spillage behind the counter.
- Double-glazed doors insulated with low thermal emissivity to reduce heat transfer with ergonomic handle.
- 10 HACCP alarms capacity which are store when high temperature variation and devices power failure.
- Removable and height adjustable epoxy coated GN 1/1 grids with a maximum loading capacity of up to 40 kg.



MODEL	DIMENSIONS (MM)	VOLUME (L)	TEMPERATURE (°C)	DEFROST	GAS	COOLING POWER (KW)	ELECTRIC POWER (KW)	ENERGY EFFICIENCY CLASS	ANNUAL CONSUMPTION (KWH)	FREQUENCY	REFERENCE	€
ACP-2G GD	1.340 x 700 x 850	302	0 +8 °C	Stop	R-600a	0,36 (1)	0,17	D	697 (5)	50 Hz	19089535	-
					R-600a	0,36 (1)	0,17	-	-	60 Hz	19090344	-
ACP-3G GD	1.790 x 700 x 850	446	0 +8 °C	Stop	R-600a	0,36 (1)	0,17	C	730 (5)	50 Hz	19089536	-
					R-600a	0,36 (1)	0,181	-	-	60 Hz	19090345	-
ACP-4G GD	2.240 x 700 x 850	590	0 +8 °C	Stop	R-600a	0,36 (1)	0,17	D	949 (5)	50 Hz	19089537	-
					R-600a	0,36 (1)	0,185	-	-	60 Hz	19090346	-

(1) Evap. -10°C/ Cond. 45°C

Options

		ACP-2G GD (€)	ACP-3G GD (€)	ACP-4G GD (€)
Connectivity	K	o	o	o
Panoramic opening	PO	 o	o	o
Left group	LG	 o	o	o
No top	NT	 o	o	o
No splash-back	NS	 o	o	o
G type plug	CI	 o	o	o
Lock	LC	●	●	●
Remote group	RG	o	o	o
Granite top	GR	o	o	o
Castors	C	o	o	o
Back in Stainless Steel	BS	o	o	o
Frame heater	FH	o	o	o
Glass door	GD	●	●	●

Standard Accessories

CODE	DESCRIPTION	2G	3G	4G	€
19097778	GN 1/1 epoxy grid	pc 2	3	4	-
19010200	Tray support guides L=613 mm	pc 4	6	8	-

Other Accessories

CODE	DESCRIPTION	€
19096243	Kit drawers 1/2+1/2 GN	-
19096245	Kit drawers 1/3+1/3+1/3 GN	-
19096244	Kit drawers 1/3+2/3 GN	-

CONCEPT

700 GN 1/1



CCP-3G

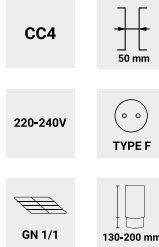

General characteristics

- Interior constructed with AISI-304 stainless steel exterior in food grade stainless steel.
- Heavy-duty stainless-steel working top with 100 mm high splash-back, preventing spillage behind the counter.
- Removable and height adjustable epoxy coated GN 1/1 grids with a maximum loading capacity of up to 40 kg.

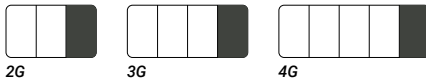

MODEL	DIMENSIONS (MM)	VOLUME (L)	TEMPERATURE (°C)	DEFROST	GAS	COOLING POWER (KW)	ELECTRIC POWER (KW)	ENERGY EFFICIENCY CLASS	ANNUAL CONSUMPTION (KWH)	FREQUENCY	REFERENCE	€
STOCK CCP-2G	1.342 x 700 x 850	274	0 +8 °C	Stop	R-600a	0,361 (1)	0,203	B	610 (4)	50 Hz	19089552	-
					R290	0,398 (1)	0,295	-	-	60 Hz	19089553	-
STOCK CCP-3G	1.792 x 700 x 850	428	0 +8 °C	Stop	R-600a	0,361 (1)	0,203	C	1.095 (4)	50 Hz	19089554	-
					R290	0,398 (1)	0,295	-	-	60 Hz	19089555	-
STOCK CCP-4G	2.242 x 700 x 850	581	0 +8 °C	Stop	R-600a	0,436 (1)	0,224	C	1.245 (4)	50 Hz	19089556	-
					R-600a	0,437 (1)	0,241	-	-	60 Hz	19089557	-
STOCK CCN-2G	1.342 x 700 x 850	274	-18 -22 °C	Electric	R290	0,364 (2)	0,317	D	2.121 (4)	50 Hz	19089561	-
					R290	0,381 (2)	0,387	-	-	60 Hz	19089562	-
STOCK CCN-3G	1.792 x 700 x 850	428	-18 -22 °C	Electric	R290	0,364 (2)	0,326	E	2.880 (4)	50 Hz	19089563	-
					R290	0,381 (2)	0,396	-	-	60 Hz	19089564	-

Options

(1) Evap. -10°C/ Cond. 45°C (2) Evap. -25°C/ Cond. 45°C (4) According to EN22041 standard

			CCP-2G (€)	CCP-3G (€)	CCP-4G (€)	CCN-2G (€)	CCN-3G (€)
Panoramic opening	PO		0	0	0	0	0
Left group	LG		0	0	0	0	0
No top	NT		0	0	0	0	0
No splash-back	NS		0	0	0	0	0
1/2 + 1/2 Drawer	H		0	0	0	-	-
1/3 + 1/3 + 1/3 Drawer	T		0	0	0	-	-
2/3 + 1/3 Drawer	W		0	0	0	-	-
G type plug	CI		0	0	0	0	0
Lock	LC		0	0	0	0	0
Granite top	GR		0	0	0	0	0
Castors	C		0	0	0	0	0
Back in Stainless Steel	BS		0	0	0	0	0
Frame heater	FH		0	0	0	●	●

Standard Accessories

	CODE	DESCRIPTION	2G	3G	4G	€	
	19097778	GN 1/1 epoxi grid	pc	2	3	4	-
	19014778	Tray support guides L=562 mm	pc	4	6	8	-

Other Accessories

	CODE	DESCRIPTION	€
	19010993	Kit drawers 1/2+1/2 GN	-
	19015952	Kit drawers 1/2+1/2 group side	-
	19036401	Kit drawers 1/2+1/2 group side LG	-
	19015954	Kit drawers 1/3+1/3+1/3	-
	19015953	Kit drawer 1/3+2/3	-

CONCEPT

700 GN 1/1 with drawers



CCP-3G HHD

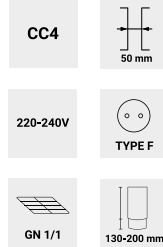

General characteristics

- Interior constructed with AISI-304 stainless steel exterior in food grade stainless steel.
- Heavy-duty stainless-steel working top with 100 mm high splash-back, preventing spillage behind the counter.
- Removable and height adjustable epoxy coated GN 1/1 grids with a maximum loading capacity of up to 40 kg.

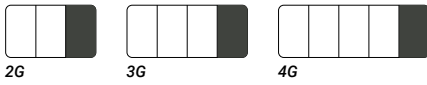

MODEL	DIMENSIONS (MM)	VOLUME (L)	TEMPERATURE (°C)	DEFROST	GAS	COOLING POWER (KW)	ELECTRIC POWER (KW)	ENERGY EFFICIENCY CLASS	ANNUAL CONSUMPTION (KWH)	FREQUENCY	REFERENCE	€
CCP-2G HD	1.342 x 700 x 850	274	0 +8 °C	Stop	R-600a	0,361 (1)	0,203	B	610 (4)	50 Hz	19089567	-
					R290	0,398 (1)	0,295	-	-	60 Hz	19090361	-
CCP-2G HH	1.342 x 700 x 850	274	0 +8 °C	Stop	R-600a	0,361 (1)	0,203	B	610 (4)	50 Hz	19089568	-
					R290	0,398 (1)	0,295	-	-	60 Hz	19090362	-
CCP-3G HDD	1.792 x 700 x 850	428	0 +8 °C	Stop	R-600a	0,361 (1)	0,203	C	1.095 (4)	50 Hz	19089569	-
					R290	0,398 (1)	0,295	-	-	60 Hz	19090363	-
CCP-3G HHD	1.792 x 700 x 850	428	0 +8 °C	Stop	R-600a	0,361 (1)	0,203	C	1.095 (4)	50 Hz	19089570	-
					R290	0,398 (1)	0,295	-	-	60 Hz	19090364	-
CCP-3G HHH	1.792 x 700 x 850	428	0 +8 °C	Stop	R-600a	0,361 (1)	0,203	C	1.095 (4)	50 Hz	19089571	-
					R290	0,398 (1)	0,295	-	-	60 Hz	19090365	-
CCP-4G HDDD	2.242 x 700 x 850	581	0 +8 °C	Stop	R-600a	0,436 (1)	0,224	D	1.245 (4)	50 Hz	19089572	-
					R-600a	0,437 (1)	0,241	-	-	60 Hz	19090366	-
CCP-4G HHDD	2.242 x 700 x 850	581	0 +8 °C	Stop	R-600a	0,436 (1)	0,224	D	1.245 (4)	50 Hz	19089573	-
					R-600a	0,437 (1)	0,241	-	-	60 Hz	19090367	-
CCP-4G HHHH	2.242 x 700 x 850	581	0 +8 °C	Stop	R-600a	0,436 (1)	0,224	D	1.245 (4)	50 Hz	19089574	-
					R-600a	0,437 (1)	0,241	-	-	60 Hz	19090368	-
CCP-4G HHHH	2.242 x 700 x 850	581	0 +8 °C	Stop	R-600a	0,436 (1)	0,224	D	1.245 (4)	50 Hz	19089575	-
					R-600a	0,437 (1)	0,241	-	-	60 Hz	19090369	-

(1) Evap. -10°C/ Cond. 45°C (2) Evap. -25°C/ Cond. 45°C (4) According to EN22041 standard

Options

			CCP-2G HD (€)	CCP-2G HH (€)	CCP-3G HDD (€)	CCP-3G HHD (€)	CCP-3G HHH (€)	CCP-4G HDDD (€)	CCP-4G HHDD (€)	CCP-4G HHHH (€)	CCP-4G HHHH (€)
Panoramic opening	PO		-	-	0	-	-	0	0	-	-
Left group	LG		0	0	0	0	0	0	0	0	0
No top	NT		0	0	0	0	0	0	0	0	0
No splash-back	NS		0	0	0	0	0	0	0	0	0
G type plug	CI		0	0	0	0	0	0	0	0	0
Granite top	GR		0	0	0	0	0	0	0	0	0
Castors	C		0	0	0	0	0	0	0	0	0
Back in Stainless Steel	BS		0	0	0	0	0	0	0	0	0
Frame heater	FH		0	0	0	0	0	0	0	0	0

CONCEPT

700 GN 1/1 with sinks



CCP-3G/S

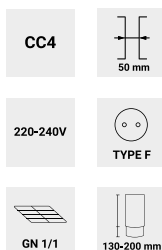

General characteristics

- Interior constructed with AISI-304 stainless steel exterior in food grade stainless steel.
- Heavy-duty stainless-steel working top with 100 mm high splash-back, preventing spillage behind the counter with 330x330x200 mm stamped bowl.
- Removable and height adjustable epoxy coated GN 1/1 grids with a maximum loading capacity of up to 40 kg.

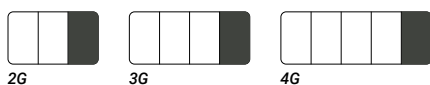

MODEL	DIMENSIONS (MM)	VOLUME (L)	TEMPERATURE (°C)	DEFROST	GAS	COOLING POWER (KW)	ELECTRIC POWER (KW)	ENERGY EFFICIENCY CLASS	ANNUAL CONSUMPTION (KWH)	FREQUENCY	REFERENCE	€
CCP-2G/S	1.342 x 700 x 850	274	0 +8 °C	Stop	R-600a	0,361 (1)	0,203	B	610 (4)	50 Hz	19089591	-
					R290	0,398 (1)	0,295	-	-	60 Hz	19090373	-
CCP-3G/S	1.792 x 700 x 850	428	0 +8 °C	Stop	R-600a	0,361 (1)	0,203	C	1.095 (4)	50 Hz	19089592	-
					R290	0,398 (1)	0,295	-	-	60 Hz	19090374	-
CCP-4G/S	2.242 x 700 x 850	581	0 +8 °C	Stop	R-600a	0,436 (1)	0,224	C	1.245 (4)	50 Hz	19089593	-
					R-600a	0,437 (1)	0,241	-	-	60 Hz	19090375	-
CCN-2G/S	1.342 x 700 x 850	274	-18 -22 °C	Electric	R290	0,364 (2)	0,317	D	2.121 (4)	50 Hz	19106963	-
					R290	0,381 (2)	0,387	-	-	60 Hz	19110986	-
CCN-3G/S	1.792 x 700 x 850	428	-18 -22 °C	Electric	R290	0,364 (2)	0,326	E	2.880 (4)	50 Hz	19106020	-
					R290	0,381 (2)	0,396	-	-	60 Hz	19110987	-

(1) Evap. -10°C/ Cond. 45°C (2) Evap. -25°C/ Cond. 45°C (4) According to EN22041 standard

Options

			CCP-2G/S (€)	CCP-3G/S (€)	CCP-4G/S (€)	CCN-2G/S (€)	CCN-3G/S (€)
Panoramic opening	PO		0	0	0	0	0
Left group	LG		0	0	0	0	0
No splash-back	NS		0	0	0	0	0
1/2 + 1/2 Drawer	H		0	0	0	-	-
1/3 + 1/3 + 1/3 Drawer	T		0	0	0	-	-
2/3 + 1/3 Drawer	W		0	0	0	-	-
G type plug	CI		0	0	0	0	0
Lock	LC		0	0	0	0	0
Castors	C		0	0	0	0	0
Back in Stainless Steel	BS		0	0	0	0	0
Frame heater	FH		0	0	0	●	●

Standard Accessories

	CODE	DESCRIPTION	2G	3G	4G	€	
	19097778	GN 1/1 epoxy grid	pc	2	3	4	-
	19014778	Tray support guides L=562 mm	pc	4	6	8	-

Other Accessories

	CODE	DESCRIPTION	€
	19010993	Kit drawers 1/2+1/2 GN	-
	19015952	Kit drawers 1/2+1/2 group side	-
	19036401	Kit drawers 1/2+1/2 group side LG	-
	19015954	Kit drawers 1/3+1/3+1/3	-
	19015953	Kit drawers 1/3+2/3	-

CONCEPT

700 GN 1/1 Central



CCP-3G/C

- CC4
- 220-240V
- GN 1/1

General characteristics

- Interior constructed with AISI-304 stainless steel exterior in food grade stainless steel.
- Heavy-duty stainless-steel flat working top without splashback.
- Doors on both sides for enhance back and front access to the cooling chamber thus gaining flexibility at work.
- Removable and height adjustable epoxy coated GN 1/1 grids with a maximum loading capacity of up to 40 kg.

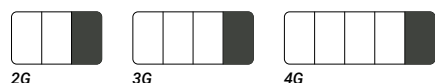

MODEL	DIMENSIONS (MM)	VOLUME (L)	TEMPERATURE (°C)	DEFROST	GAS	COOLING POWER (KW)	ELECTRIC POWER (KW)	FREQUENCY	REFERENCE	€
CCPC-2G/C	1.342 x 778 x 850	274	0 +8 °C	Stop	R-600a	0,361 (1)	0,203	50 Hz	19089594	-
					R290	0,398 (1)	0,295	60 Hz	19090376	-
CCPC-3G/C	1.792 x 778 x 850	428	0 +8 °C	Stop	R-600a	0,361 (1)	0,203	50 Hz	19089595	-
					R290	0,398 (1)	0,295	60 Hz	19090377	-
CCPC-4G/C	2.242 x 778 x 850	581	0 +8 °C	Stop	R-600a	0,436 (1)	0,224	50 Hz	19089596	-
					R-600a	0,437 (1)	0,241	60 Hz	19090378	-

(1) Evap. -10°C/ Cond. 45°C

Options

			CCPC-2G/C (€)	CCP-3G/C (€)	CCPC-4G/C (€)
Panoramic opening	PO		o	o	o
No top	NT		o	o	o
No splash-back	NS		●	●	●
G type plug	Cl		o	o	o
Lock	LC		o	o	o
Frame heater	FH		o	o	o

Standard Accessories

	CODE	DESCRIPTION		2G	3G	4G	€
	19097778	GN 1/1 epoxy grid	pc	2	3	4	-
	19010200	Tray support guides L=613 mm	pc	4	6	8	-

CONCEPT

700 GN 1/1 Remote



CCP-3G/R

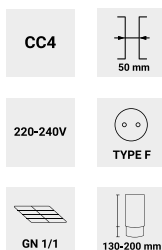

General characteristics

- Interior constructed with AISI-304 stainless steel exterior in food grade stainless steel.
- Heavy-duty stainless-steel working top with 100 mm high splash-back, preventing spillage behind the counter.
- Equipment without unit condenser, ready for remote cooling unit connection.
- Removable and height adjustable epoxy coated GN 1/1 grids with a maximum loading capacity of up to 40 kg.

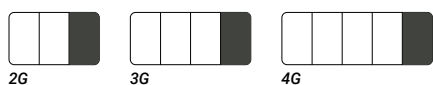

2G

3G

4G



MODEL	DIMENSIONS (MM)	VOLUME (L)	TEMPERATURE (°C)	DEFROST	GAS	COOLING POWER (KW)	ELECTRIC POWER (KW)	FREQUENCY	REFERENCE	€
CCP-2G/R	1.042 x 700 x 850	274	0 +8 °C	Stop	(6)	0,361 (1)	0,029	50/60 Hz	19089558	-
CCP-3G/R	1.492 x 700 x 850	428	0 +8 °C	Stop	(6)	0,361 (1)	0,029	50/60 Hz	19089559	-
CCP-4G/R	1.942 x 700 x 850	581	0 +8 °C	Stop	(6)	0,436 (1)	0,029	50/60 Hz	19089560	-
CCN-2G/R	1.042 x 700 x 850	274	-18 -22 °C	Electric	(6)	0,364 (2)	0,064	50/60 Hz	19089565	-
CCN-3G/R	1.492 x 700 x 850	428	-18 -22 °C	Electric	(6)	0,364 (2)	0,073	50/60 Hz	19089566	-

(1) Evap. -10°C/ Cond. 45°C (2) Evap. -25°C/ Cond. 45°C (6) Consult the manufacturer

Options

			CCP-2G/R (€)	CCP-3G/R (€)	CCP-4G/R (€)	CCN-2G/R (€)	CCN-3G/R (€)
Panoramic opening	PO		0	0	0	0	0
No top	NT		0	0	0	0	0
No splash-back	NS		0	0	0	0	0
1/2 + 1/2 Drawer	H		0	0	0	-	-
1/3 + 1/3 +1/3 Drawer	T		0	0	0	-	-
2/3 + 1/3 Drawer	W		0	0	0	-	-
G type plug	CI		0	0	0	0	0
Lock	LC		0	0	0	0	0
Granite top	GR		0	0	0	0	0
Back in Stainless Steel	BS		0	0	0	0	0
Frame heater	FH		0	0	0	●	●

Standard Accessories

CODE	DESCRIPTION	2G	3G	4G	€	
19097778	GN 1/1 epoxy grid	pc	2	3	4	-
19014778	Tray support guides L=562 mm	pc	4	6	8	-

Other Accessories

CODE	DESCRIPTION	€
19010993	Kit drawers 1/2+1/2 GN	-
19015952	Kit drawers 1/2+1/2 group side	-
19015954	Kit drawers 1/3+1/3+1/3	-
19015953	Kit drawers 1/3+2/3	-

CONCEPT

700 GN 1/1 Remote with drawers



CCP-3G/R HHD

CC4

220-240V

GN 1/1

50 mm

TYPE F

130-200 mm

General characteristics

- Interior constructed with AISI-304 stainless steel exterior in food grade stainless steel.
- Heavy-duty stainless-steel working top with 100 mm high splash-back, preventing spillage behind the counter.
- Equipment without unit condenser, ready for remote cooling unit connection.
- Removable and height adjustable epoxy coated GN 1/1 grids with a maximum loading capacity of up to 40 kg.

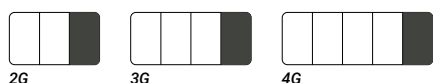

MODEL	DIMENSIONS (MM)	VOLUME (L)	TEMPERATURE (°C)	DEFROST	GAS	COOLING POWER (KW)	ELECTRIC POWER (KW)	FREQUENCY	REFERENCE	€
CCP-2G/R HD	1.042 x 700 x 850	274	0 +8 °C	Stop	(6)	0,361 (1)	0,029	50/60 Hz	19089576	-
CCP-2G/R HH	1.042 x 700 x 850	274	0 +8 °C	Stop	(6)	0,361 (1)	0,029	50/60 Hz	19089577	-
CCP-3G/R HDD	1.492 x 700 x 850	428	0 +8 °C	Stop	(6)	0,361 (1)	0,029	50/60 Hz	19089578	-
CCP-3G/R HHD	1.492 x 700 x 850	428	0 +8 °C	Stop	(6)	0,361 (1)	0,029	50/60 Hz	19089579	-
CCP-3G/R HHH	1.492 x 700 x 850	428	0 +8 °C	Stop	(6)	0,361 (1)	0,029	50/60 Hz	19089580	-
CCP-4G/R HDDD	1.942 x 700 x 850	581	0 +8 °C	Stop	(6)	0,436 (1)	0,029	50/60 Hz	19089581	-
CCP-4G/R HHDD	1.942 x 700 x 850	581	0 +8 °C	Stop	(6)	0,436 (1)	0,029	50/60 Hz	19089582	-
CCP-4G/R HHHD	1.942 x 700 x 850	581	0 +8 °C	Stop	(6)	0,436 (1)	0,029	50/60 Hz	19089583	-
CCP-4G/R HHHH	1.942 x 700 x 850	581	0 +8 °C	Stop	(6)	0,436 (1)	0,029	50/60 Hz	19089584	-

(1) Evap. -10°C/ Cond. 45°C (2) Evap. -25°C/ Cond. 45°C (6) Consult the manufacturer

Options

			CCP-2G/R HD (€)	CCP-2G/R HH (€)	CCP-3G/R HDD (€)	CCP-3G/R HHD (€)	CCP-3G/R HHH (€)	CCP-4G/R HDDD (€)	CCP-4G/R HHDD (€)	CCP-4G/R HHHD (€)	CCP-4G/R HHHH (€)
Panoramic opening	PO		-	-	0	-	-	0	0	-	-
No top	NT		0	0	0	0	0	0	0	0	0
No splash-back	NS		0	0	0	0	0	0	0	0	0
G type plug	CI		0	0	0	0	0	0	0	0	0
Granite top	GR		0	0	0	0	0	0	0	0	0
Back in Stainless Steel	BS		0	0	0	0	0	0	0	0	0
Frame heater	FH		0	0	0	0	0	0	0	0	0

CONCEPT

700 GN 1/1 Display



CCP-3G GD

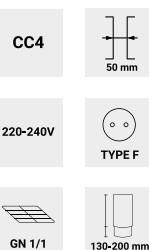

General characteristics

- Interior constructed with AISI-304 stainless steel exterior in food grade stainless steel.
- Heavy-duty stainless-steel working top with 100 mm high splash-back, preventing spillage behind the counter.
- Double-glazed doors insulated with low thermal emissivity to reduce heat transfer with ergonomic handle.
- Removable and height adjustable epoxy coated GN 1/1 grids with a maximum loading capacity of up to 40 kg.

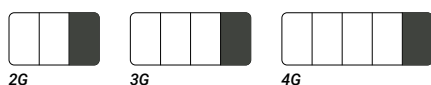

2G

3G

4G



MODEL	DIMENSIONS (MM)	VOLUME (L)	TEMPERATURE (°C)	DEFROST	GAS	COOLING POWER (KW)	ELECTRIC POWER (KW)	ENERGY EFFICIENCY CLASS	ANNUAL CONSUMPTION (KWH)	FREQUENCY	REFERENCE	€
CCP-2G GD	1.342 x 700 x 850	274	0 +8 °C	Stop	R-600a	0,361 (1)	0,205	C	1.241 (5)	50 Hz	19089585	-
					R290	0,398 (1)	0,297	-	-	60 Hz	19090370	-
CCP-3G GD	1.792 x 700 x 850	428	0 +8 °C	Stop	R-600a	0,361 (1)	0,207	C	1.536 (5)	50 Hz	19089586	-
					R290	0,398 (1)	0,299	-	-	60 Hz	19090371	-
CCP-4G GD	2.242 x 700 x 850	581	0 +8 °C	Stop	R-600a	0,436 (1)	0,23	C	1.808 (5)	50 Hz	19089587	-
					R-600a	0,437 (1)	0,247	-	-	60 Hz	19090372	-

(1) Evap. -10°C/ Cond. 45°C (5) According to EN23953 standard

Options

			CCP-2G GD (€)	CCP-3G GD (€)	CCP-4G GD (€)
Panoramic opening	PO		o	o	o
Left group	LG		o	o	o
No top	NT		o	o	o
No splash-back	NS		o	o	o
G type plug	CI		o	o	o
Lock	LC		●	●	●
Granite top	GR		o	o	o
Castors	C		o	o	o
Back in Stainless Steel	BS		o	o	o
Frame heater	FH		o	o	o
Glass door	GD		●	●	●

Standard Accessories

	CODE	DESCRIPTION		2G	3G	4G	€
	19097778	GN 1/1 epoxy grid	pc	2	3	4	-
	19014778	Tray support guides L=562 mm	pc	4	6	8	-

Other Accessories

	CODE	DESCRIPTION	€
	19010993	Kit drawers 1/2+1/2 GN	-
	19015952	Kit drawers 1/2+1/2 group side	-
	19036401	Kit drawers 1/2+1/2 group side LG	-
	19015954	Kit drawers 1/3+1/3+1/3	-
	19015953	Kit drawers 1/3+2/3	-

CONCEPT

700 GN 1/1 Remote display



CCP-3G/R GD

CC4	
220-240V	
GN 1/1	

General characteristics



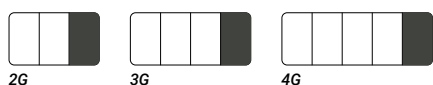

- Interior constructed with AISI-304 stainless steel exterior in food grade stainless steel.
- Heavy-duty stainless-steel working top with 100 mm high splash-back, preventing spillage behind the counter.
- Equipment without unit condenser, ready for remote cooling unit connection.
- Double-glazed doors insulated with low thermal emissivity to reduce heat transfer with ergonomic handle.
- Removable and height adjustable epoxy coated GN 1/1 grids with a maximum loading capacity of up to 40 kg.





MODEL	DIMENSIONS (MM)	VOLUME (L)	TEMPERATURE (°C)	DEFROST	GAS	COOLING POWER (KW)	ELECTRIC POWER (KW)	FREQUENCY	REFERENCE	€
CCP-2G/R GD	1.042 x 700 x 850	274	0 +8 °C	Stop	(6)	0,361 (1)	0,031	50/60 Hz	19089588	-
CCP-3G/R GD	1.492 x 700 x 850	428	0 +8 °C	Stop	(6)	0,361 (1)	0,033	50/60 Hz	19089589	-
CCP-4G/R GD	1.942 x 700 x 850	581	0 +8 °C	Stop	(6)	0,436 (1)	0,035	50/60 Hz	19089590	-

(1) Evap. -10°C/ Cond. 45°C (6) Consult the manufacturer





Options

			CCP-2G/R GD (€)	CCP-3G/R GD (€)	CCP-4G/R GD (€)
Panoramic opening	PO		o	o	o
No top	NT		o	o	o
No splash-back	NS		o	o	o
G type plug	CI		o	o	o
Lock	LC		●	●	●
Granite top	GR		o	o	o
Back in Stainless Steel	BS		o	o	o
Frame heater	FH		o	o	o
Glass door	GD		●	●	●

Standard Accessories

	CODE	DESCRIPTION		2G	3G	4G	€
	19097778	GN 1/1 epoxy grid	pc	2	3	4	-
	19014778	Tray support guides L=562 mm	pc	4	6	8	-

Other Accessories

	CODE	DESCRIPTION	€
	19010993	Kit drawers 1/2+1/2 GN	-
	19015952	Kit drawers 1/2+1/2 group side	-
	19015954	Kit drawers 1/3+1/3+1/3	-
	19015953	Kit drawers 1/3+2/3	-

CONCEPT

700 GN 1/1 Refrigerated bases



CCPB-3G

CC4



220-240V



GN 1/1



General characteristics

- Interior constructed with AISI-304 stainless steel exterior in food grade stainless steel.
- Heavy-duty stainless-steel working top with 100 mm high splash-back, preventing spillage behind the counter.
- Intended to give support to counter top cooking equipment. Ideal for refrigeration solutions in small rooms.
- Removable and height adjustable epoxy coated GN 1/1 grids with a maximum loading capacity of up to 40 kg.



2G

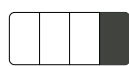

3G

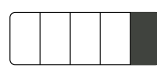

4G



MODEL	DIMENSIONS (MM)	VOLUME (L)	TEMPERATURE (°C)	DEFROST	GAS	COOLING POWER (KW)	ELECTRIC POWER (KW)	ENERGY EFFICIENCY CLASS	ANNUAL CONSUMPTION (KWH)	FREQUENCY	REFERENCE	€
CCPB-2G	1.342 x 700 x 584	177	0 +8 °C	Stop	R-600a	0,361 (1)	0,203	C	956 (4)	50 Hz	19089597	-
					R290	0,398 (1)	0,295	-	-	60 Hz	19089598	-
CCPB-3G	1.792 x 700 x 584	277	0 +8 °C	Stop	R-600a	0,361 (1)	0,203	D	1.095 (4)	50 Hz	19089599	-
					R290	0,398 (1)	0,295	-	-	60 Hz	19089600	-
CCPB-4G	2.242 x 700 x 584	377	0 +8 °C	Stop	R-600a	0,436 (1)	0,224	D	1.245 (4)	50 Hz	19089601	-
					R-600a	0,437 (1)	0,241	-	-	60 Hz	19089602	-

(1) Evap. -10°C/ Cond. 45°C (4) According to EN22041 standard

Options

			CCPB-2G (€)	CCPB-3G (€)	CCPB-4G (€)
Panoramic opening	PO		o	o	o
No splash-back	NS		●	●	●
G type plug	CI		o	o	o
Lock	LC		o	o	o
Castors	C		o	o	o
Back in Stainless Steel	BS		o	o	o
Frame heater	FH		o	o	o

Standard Accessories

	CODE	DESCRIPTION	2G	3G	4G	€
	19097778	GN 1/1 epoxy grid	pc 2	3	4	-
	19014778	Tray support guides L=562 mm	pc 4	6	8	-

Other Accessories

	CODE	DESCRIPTION	€
	19072745	Kit drawers 1/3+1/3	-

CONCEPT

700 GN 1/1 Refrigerated bases with drawers



CCPB-3G W

CCPB-3G T

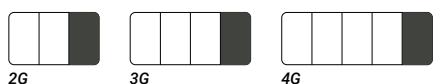

2G

3G

4G

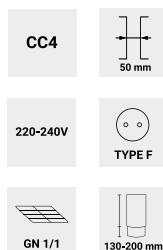

General characteristics

- Interior constructed with AISI-304 stainless steel exterior in food grade stainless steel.
- Heavy-duty stainless-steel working top with 100 mm high splash-back, preventing spillage behind the counter.
- Intended to give support to counter top cooking equipment. Ideal for refrigeration solutions in small rooms.
- Removable and height adjustable epoxy coated GN 1/1 grids with a maximum loading capacity of up to 40 kg.



MODEL	DIMENSIONS (MM)	VOLUME (L)	TEMPERATURE (°C)	DEFROST	GAS	COOLING POWER (KW)	ELECTRIC POWER (KW)	ENERGY EFFICIENCY CLASS	ANNUAL CONSUMPTION (KWH)	FREQUENCY	REFERENCE	€
CCPB-2G W	1.342 x 700 x 584	177	0 +8 °C	Stop	R-600a	0,361 (1)	0,203	C	956 (4)	50 Hz	19089603	-
					R290	0,398 (1)	0,295	-	-	60 Hz	19089604	-
CCPB-3G W	1.792 x 700 x 584	277	0 +8 °C	Stop	R-600a	0,361 (1)	0,203	D	1.095 (4)	50 Hz	19089605	-
					R290	0,398 (1)	0,295	-	-	60 Hz	19089606	-
CCPB-4G W	2.242 x 700 x 584	377	0 +8 °C	Stop	R-600a	0,436 (1)	0,224	D	1.245 (4)	50 Hz	19089607	-
					R-600a	0,437 (1)	0,241	-	-	60 Hz	19089608	-
CCPB-2G T	1.342 x 700 x 584	177	0 +8 °C	Stop	R-600a	0,361 (1)	0,203	C	956 (4)	50 Hz	19089609	-
					R290	0,398 (1)	0,295	-	-	60 Hz	19089610	-
CCPB-3G T	1.792 x 700 x 584	277	0 +8 °C	Stop	R-600a	0,361 (1)	0,203	D	1.095 (4)	50 Hz	19089611	-
					R290	0,398 (1)	0,295	-	-	60 Hz	19089612	-
CCPB-4G T	2.242 x 700 x 584	377	0 +8 °C	Stop	R-600a	0,436 (1)	0,224	D	1.245 (4)	50 Hz	19089613	-
					R-600a	0,437 (1)	0,241	-	-	60 Hz	19089614	-

(1) Evap. -10°C/ Cond. 45°C (2) Evap. -25°C/ Cond. 45°C (4) According to EN22041 standard

Options

			CCPB-2G W (€)	CCPB-3G W (€)	CCPB-4G W (€)	CCPB-2G T (€)	CCPB-3G T (€)	CCPB-4G T (€)
No splash-back	NS		●	●	●	●	●	●
G type plug	Cl		○	○	○	○	○	○
Castors	C		○	○	○	○	○	○
Back in Stainless Steel	BS		○	○	○	○	○	○
Frame heater	FH		○	○	○	○	○	○

CONCEPT

Refrigerated Bases 700



CCP7-3G W

CCP7-2G W2

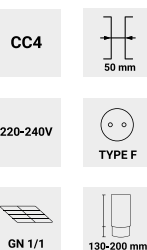

General characteristics

- Interior constructed with AISI-304 stainless steel exterior in food grade stainless steel.
- Heavy-duty stainless-steel working top with 100 mm high splash-back, preventing spillage behind the counter.
- Removable and height adjustable epoxy coated GN 2/3 grids with a maximum loading capacity of up to 40 kg.
- Equipment with 1 GN 2/3 grids and height adjustable 2 sets of tray slides per each full door.
- W model drawers with GN2/3 holding capacity.
- W2 model drawers with 2x GN2/3 holding capacity.



MODEL	DIMENSIONS (MM)	VOLUME (L)	TEMPERATURE (°C)	DEFROST	GAS	COOLING POWER (KW)	ELECTRIC POWER (KW)	ENERGY EFFICIENCY CLASS	ANNUAL CONSUMPTION (KWh)	FREQUENCY	REFERENCE	€
CCP7-2G	1.207 x 700 x 590	110	0 +8 °C	Stop	R290	0,369 (1)	0,249	C	730 (4)	50 Hz	19104999	-
					R290	0,369 (1)	0,249	-	-	60 Hz	19110970	-
CCP7-2G W	1.207 x 700 x 590	110	0 +8 °C	Stop	R290	0,369 (1)	0,249	C	730 (4)	50 Hz	19105020	-
					R290	0,369 (1)	0,249	-	-	60 Hz	19110976	-
CCP7-2G W2	1.207 x 700 x 590	110	0 +8 °C	Stop	R290	0,369 (1)	0,262	C	730 (4)	50 Hz	19105021	-
					R290	0,369 (1)	0,262	-	-	60 Hz	19110978	-
CCP7-3G	1.607 x 700 x 590	169	0 +8 °C	Stop	R290	0,369 (1)	0,249	D	1.095 (4)	50 Hz	19105022	-
					R290	0,369 (1)	0,249	-	-	60 Hz	19110979	-
CCP7-3G W	1.607 x 700 x 590	169	0 +8 °C	Stop	R290	0,369 (1)	0,249	D	1.095 (4)	50 Hz	19105023	-
					R290	0,369 (1)	0,249	-	-	60 Hz	19110980	-

(1) Evap. -10°C/ Cond. 45°C (4) According to EN22041 standard

Options

			CCP7-2G (€)	CCP7-2G W (€)	CCP7-2G W2 (€)	CCP7-3G (€)	CCP7-3G W (€)
Panoramic opening	PO		●	-	-	●	-
No splash-back	NS		●	●	●	●	●
G type plug	CI		○	○	○	○	○
Remote group	RG		○	○	○	○	○
Castors	C		○	○	○	○	○
Back in Stainless Steel	BS		●	●	●	●	●
Frame heater	FH		○	○	○	○	○

Standard Accessories

	CODE	DESCRIPTION		2G	3G	€
	19106414	GN 2/3 Epoxy grid	pc	2	3	-
	19033558	Tray support guides L=496 mm	pc	4	6	-

Other Accessories

	CODE	DESCRIPTION	€
	19072745	Kit drawers 1/3+1/3	-

CONCEPT

Refrigerated Bases 900

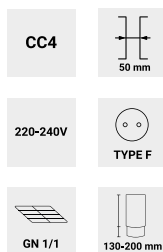

General characteristics

- Interior constructed with AISI-304 stainless steel exterior in food grade stainless steel.
- Heavy-duty stainless-steel working top with 100 mm high splash-back, preventing spillage behind the counter.
- Removable and height adjustable epoxy coated GN 1/1 grids with a maximum loading capacity of up to 40 kg.
- Equipment with 1 GN 1/1 grids and height adjustable 2 sets of tray slides per each full door.
- W model drawers with GN1/1 holding capacity.
- W2 model drawers with 2 x GN1/1 or 1x GN2/1 holding capacity.



MODEL	DIMENSIONS (MM)	VOLUME (L)	TEMPERATURE (°C)	DEFROST	GAS	COOLING POWER (KW)	ELECTRIC POWER (KW)	ENERGY EFFICIENCY CLASS	ANNUAL CONSUMPTION (KWH)	FREQUENCY	REFERENCE	€
CCP9-2G	1.207 x 900 x 590	169	0 +8 °C	Stop	R290	0,369 (1)	0,25	C	730 (4)	50 Hz	19105024	-
					R290	0,369 (1)	0,25	-	-	60 Hz	19110994	-
CCP9-2G W	1.207 x 900 x 590	169	0 +8 °C	Stop	R290	0,369 (1)	0,25	C	730 (4)	50 Hz	19105025	-
					R290	0,369 (1)	0,25	-	-	60 Hz	19110995	-
CCP9-2G W2	1.207 x 900 x 590	169	0 +8 °C	Stop	R290	0,369 (1)	0,262	C	730 (4)	50 Hz	19105026	-
					R290	0,369 (1)	0,262	-	-	60 Hz	19111001	-
CCP9-3G	1.607 x 900 x 590	240	0 +8 °C	Stop	R290	0,369 (1)	0,249	D	1.095 (4)	50 Hz	19105027	-
					R290	0,369 (1)	0,249	-	-	60 Hz	19111004	-
CCP9-3G W	1.607 x 900 x 590	240	0 +8 °C	Stop	R290	0,369 (1)	0,249	D	1.095 (4)	50 Hz	19105028	-
					R290	0,369 (1)	0,249	-	-	60 Hz	19111007	-

(1) Evap. -10°C/ Cond. 45°C (4) According to EN22041 standard

Options

			CCP9-2G (€)	CCP9-2G W (€)	CCP9-2G W2 (€)	CCP9-3G (€)	CCP9-3G W (€)
Panoramic opening	PO		●	-	-	●	-
No splash-back	NS		●	●	●	●	●
G type plug	CI		○	○	○	○	○
Remote group	RG		○	○	○	○	○
Castors	C		○	○	○	○	○
Back in Stainless Steel	BS		●	●	●	●	●
Frame heater	FH		○	○	○	○	○

Standard Accessories

CODE	DESCRIPTION	2G	3G	€	
19097778	GN1/1 Epoxy grid	pc	2	3	-
19033557	Tray support guides L=649 mm	pc	4	6	-

Other Accessories

CODE	DESCRIPTION	€
19072745	Kit drawers 1/3+1/3	-

CONCEPT

600 Snack



CCP-3S

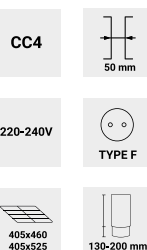

General characteristics

- Interior constructed with AISI-304 stainless steel exterior in food grade stainless steel.
- Heavy-duty stainless-steel working top with 100 mm high splash-back, preventing spillage behind the counter.
- Removable and height adjustable epoxy coated grids with a maximum loading capacity of up to 40 kg.
- Equipped with 1 grid 405x460 mm in each edge door and 1 grid 405x525 in centered doors and height adjustable 2 sets of tray slides per each full door.

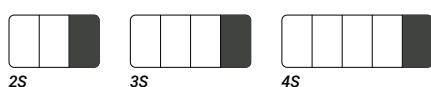

	MODEL	DIMENSIONS (MM)	VOLUME (L)	TEMPERATURE (°C)	DEFROST	GAS	COOLING POWER (KW)	ELECTRIC POWER (KW)	ENERGY EFFICIENCY CLASS	ANNUAL CONSUMPTION (KWH)	FREQUENCY	REFERENCE	€
⊗ STOCK	CCP-2S	1.492 x 600 x 850	268	0 +8 °C	Stop	R-600a	0,361 (1)	0,203	C	956 (4)	50 Hz	19089625	-
						R290	0,398 (1)	0,295	-	-	60 Hz	19089626	-
⊗ STOCK	CCP-3S	2.017 x 600 x 850	416	0 +8 °C	Stop	R-600a	0,361 (1)	0,203	C	1.095 (4)	50 Hz	19089627	-
						R290	0,398 (1)	0,295	-	-	60 Hz	19089628	-
	CCP-4S	2.542 x 600 x 850	564	0 +8 °C	Stop	R-600a	0,436 (1)	0,224	C	1.245 (4)	50 Hz	19089629	-
						R-600a	0,437 (1)	0,241	-	-	60 Hz	19089630	-
⊗ STOCK	CCN-2S	1.492 x 600 x 850	268	-18 -22 °C	Electric	R290	0,364 (2)	0,319	D	2.121 (4)	50 Hz	19089634	-
						R290	0,381 (2)	0,389	-	-	60 Hz	19089635	-
⊗ STOCK	CCN-3S	2.017 x 600 x 850	416	-18 -22 °C	Electric	R290	0,364 (2)	0,329	E	2.880 (4)	50 Hz	19089636	-
						R290	0,381 (2)	0,399	-	-	60 Hz	19089637	-

Options

(1) Evap. -10°C/ Cond. 45°C (2) Evap. -25°C/ Cond. 45°C (4) According to EN22041 standard

			CCP-2S (€)	CCP-3S (€)	CCP-4S (€)	CCN-2S (€)	CCN-3S (€)
Panoramic opening	PO		0	0	0	0	0
Left Group	LG		0	0	0	0	0
No top	NT		0	0	0	0	0
No splash-back	NS		0	0	0	0	0
1/2 + 1/2 Drawer	H		0	0	0	-	-
1/3 + 1/3 +1/3 Drawer	T		0	0	0	-	-
2/3 + 1/3 Drawer	W		0	0	0	-	-
G type plug	CI		0	0	0	0	0
Lock	LC		0	0	0	0	0
Castors	C		0	0	0	0	0
Back in Stainless Steel	BS		0	0	0	0	0
Frame heater	FH		0	0	0	●	●

Standard Accessories

CODE	DESCRIPTION	2S	3S	4S	€	
19097777	Epoxy grid Snack 405x460	pc	2	2	2	-
19097775	Epoxy grid Snack 405x525	pc	-	1	2	-

Other Accessories

CODE	DESCRIPTION	€
19004925	Kit drawers 1/2+1/2 GN	-
19004921	Kit drawers 1/2+1/2 group side	-
19004930	Kit drawers 1/2+1/2 group side LG	-
19004927	Kit drawer 1/3+2/3	-
19004923	Kit drawers 1/3+1/3+1/3	-

CONCEPT

600 Snack with drawers



CCP-3S HHD

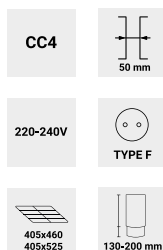

General characteristics

- Interior constructed with AISI-304 stainless steel exterior in food grade stainless steel.
- Heavy-duty stainless-steel working top with 100 mm high splash-back, preventing spillage behind the counter.
- Removable and height adjustable epoxy coated grids with a maximum loading capacity of up to 40 kg.
- Equipped with 1 grid 405x460 mm in each edge door and 1 grid 405x525 in centered doors and height adjustable 2 sets of tray slides per each full door.

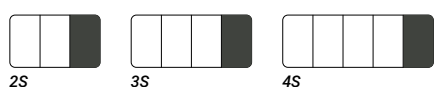

MODEL	DIMENSIONS (MM)	VOLUME (L)	TEMPERATURE (°C)	DEFROST	GAS	COOLING POWER (KW)	ELECTRIC POWER (KW)	ENERGY EFFICIENCY CLASS	ANNUAL CONSUMPTION (KWH)	FREQUENCY	REFERENCE	€
CCP-2S HD	1.492 x 600 x 850	268	0 +8 °C	Stop	R-600a	0,361 (1)	0,203	C	956 (4)	50 Hz	19089640	-
					R290	0,398 (1)	0,295	-	-	60 Hz	19090379	-
CCP-2S HH	1.492 x 600 x 850	268	0 +8 °C	Stop	R-600a	0,361 (1)	0,203	C	956 (4)	50 Hz	19089641	-
					R290	0,398 (1)	0,295	-	-	60 Hz	19090380	-
CCP-3S HDD	2.017 x 600 x 850	416	0 +8 °C	Stop	R-600a	0,361 (1)	0,203	C	1.095 (4)	50 Hz	19089642	-
					R290	0,398 (1)	0,295	-	-	60 Hz	19090381	-
CCP-3S HHD	2.017 x 600 x 850	416	0 +8 °C	Stop	R-600a	0,361 (1)	0,203	C	1.095 (4)	50 Hz	19089643	-
					R290	0,398 (1)	0,295	-	-	60 Hz	19090382	-
CCP-3S HHH	2.017 x 600 x 850	416	0 +8 °C	Stop	R-600a	0,361 (1)	0,203	C	1.095 (4)	50 Hz	19089644	-
					R290	0,398 (1)	0,295	-	-	60 Hz	19090383	-
CCP-4S HDDD	2.542 x 600 x 850	564	0 +8 °C	Stop	R-600a	0,436 (1)	0,224	C	1.245 (4)	50 Hz	19089645	-
					R-600a	0,437 (1)	0,241	-	-	60 Hz	19090384	-
CCP-4S HHDD	2.542 x 600 x 850	564	0 +8 °C	Stop	R-600a	0,436 (1)	0,224	C	1.245 (4)	50 Hz	19089646	-
					R-600a	0,437 (1)	0,241	-	-	60 Hz	19090385	-
CCP-4S HHHH	2.542 x 600 x 850	564	0 +8 °C	Stop	R-600a	0,436 (1)	0,224	C	1.245 (4)	50 Hz	19089647	-
					R-600a	0,437 (1)	0,241	-	-	60 Hz	19090386	-
CCP-4S HHHH	2.542 x 600 x 850	564	0 +8 °C	Stop	R-600a	0,436 (1)	0,224	D	1.245 (4)	50 Hz	19089648	-
					R-600a	0,437 (1)	0,241	-	-	60 Hz	19090387	-

(1) Evap. -10°C/ Cond. 45°C (2) Evap. -25°C/ Cond. 45°C (4) According to EN22041 standard

Options

			CCP-2S HD (€)	CCP-2S HH (€)	CCP-3S HDD (€)	CCP-3S HHD (€)	CCP-3S HHH (€)	CCP-4S HDDD (€)	CCP-4S HHDD (€)	CCP-4S HHHH (€)	CCP-4S HHHH (€)
Panoramic opening	PO		-	-	0	-	-	0	0	-	-
Left Group	LG		0	0	0	0	0	0	0	0	0
No top	NT		0	0	0	0	0	0	0	0	0
No splash-back	NS		0	0	0	0	0	0	0	0	0
G type plug	CI		0	0	0	0	0	0	0	0	0
Castors	C		0	0	0	0	0	0	0	0	0
Back in Stainless Steel	BS		0	0	0	0	0	0	0	0	0
Frame heater	FH		0	0	0	0	0	0	0	0	0

CONCEPT

600 Snack remote



CCP-3S/R

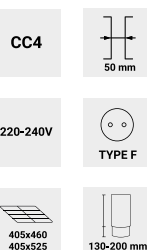

General characteristics

- Interior constructed with AISI-304 stainless steel exterior in food grade stainless steel.
- Heavy-duty stainless-steel working top with 100 mm high splash-back, preventing spillage behind the counter.
- Equipment without unit condenser, ready for remote cooling unit connection.
- Removable and height adjustable epoxy coated grids with a maximum loading capacity of up to 40 kg.
- Equipped with 1 grid 405x460 mm in each edge door and 1 grid 405x525 in centered doors and height adjustable 2 sets of tray slides per each full door.

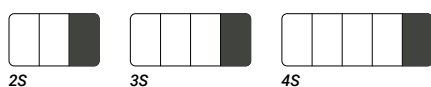

MODEL	DIMENSIONS (MM)	VOLUME (L)	TEMPERATURE (°C)	DEFROST	GAS	COOLING POWER (KW)	ELECTRIC POWER (KW)	FREQUENCY	REFERENCE	€
CCP-2S/R	1.192 x 600 x 850	268	0 +8 °C	Stop	(6)	0,361 (1)	0,029	50/60 Hz	19089631	-
CCP-3S/R	1.717 x 600 x 850	416	0 +8 °C	Stop	(6)	0,361 (1)	0,029	50/60 Hz	19089632	-
CCP-4S/R	2.242 x 600 x 850	564	0 +8 °C	Stop	(6)	0,436 (1)	0,029	50/60 Hz	19089633	-
CCN-2S/R	1.192 x 600 x 850	268	-18 -22 °C	Electric	(6)	0,364 (2)	0,066	50/60 Hz	19089638	-
CCN-3S/R	1.717 x 600 x 850	416	-18 -22 °C	Electric	(6)	0,364 (2)	0,076	50/60 Hz	19089639	-

(1) Evap. -10°C/ Cond. 45°C (2) Evap. -25°C/ Cond. 45°C (6) Consult the manufacturer

Options

			CCP-2S/R (€)	CCP-3S/R (€)	CCP-4S/R (€)	CCN-2S/R (€)	CCN-3S/R (€)
Panoramic opening	PO		0	0	0	0	0
No top	NT		0	0	0	0	0
No splash-back	NS		0	0	0	0	0
1/2 + 1/2 Drawer	H		0	0	0	-	-
1/3 + 1/3 + 1/3 Drawer	T		0	0	0	-	-
2/3 + 1/3 Drawer	W		0	0	0	-	-
G type plug	CI		0	0	0	0	0
Lock	LC		0	0	0	0	0
Back in Stainless Steel	BS		0	0	0	0	0
Frame heater	FH		0	0	0	●	●

Standard Accessories

CODE	DESCRIPTION	2S	3S	4S	€	
19097777	Epoxy grid Snack 405x460	pc	2	2	2	-
19097775	Epoxy grid Snack 405x525	pc	-	1	2	-

Other Accessories





CODE	DESCRIPTION	€
19004925	Kit drawers 1/2+1/2 GN	-
19004921	Kit drawers 1/2+1/2 group side	-
19004927	Kit drawers 1/3+2/3	-
19004923	Kit drawers 1/3+1/3+1/3	-

CONCEPT

600 Snack remote with drawers



CCP-3S/R HHD

- CC4 
- 220-240V 
-  405x460
405x525
-  130-200 mm

General characteristics



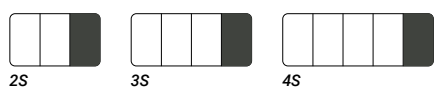

- Interior constructed with AISI-304 stainless steel exterior in food grade stainless steel.
- Heavy-duty stainless-steel working top with 100 mm high splash-back, preventing spillage behind the counter.
- Equipment without unit condenser, ready for remote cooling unit connection.
- Removable and height adjustable epoxy coated grids with a maximum loading capacity of up to 40 kg.
- Equipped with 1 grid 405x460 mm in each edge door and 1 grid 405x525 in centered doors and height adjustable 2 sets of tray slides per each full door.



MODEL	DIMENSIONS (MM)	VOLUME (L)	TEMPERATURE (°C)	DEFROST	COOLING POWER (KW)	ELECTRIC POWER (KW)	FREQUENCY	REFERENCE	€
CCP-2S/R HD	1.192 x 600 x 850	268	0 +8 °C	Stop	0,361 (1)	0,029	50/60 Hz	19089649	-
CCP-2S/R HH	1.192 x 600 x 850	268	0 +8 °C	Stop	0,361 (1)	0,029	50/60 Hz	19089650	-
CCP-3S/R HDD	1.717 x 600 x 850	416	0 +8 °C	Stop	0,361 (1)	0,029	50/60 Hz	19089651	-
CCP-3S/R HHD	1.717 x 600 x 850	416	0 +8 °C	Stop	0,361 (1)	0,029	50/60 Hz	19089653	-
CCP-3S/R HHH	1.717 x 600 x 850	416	0 +8 °C	Stop	0,361 (1)	0,029	50/60 Hz	19089654	-
CCP-4S/R HDDD	2.242 x 600 x 850	564	0 +8 °C	Stop	0,436 (1)	0,029	50/60 Hz	19089655	-
CCP-4S/R HHDD	2.242 x 600 x 850	564	0 +8 °C	Stop	0,436 (1)	0,029	50/60 Hz	19089656	-
CCP-4S/R HHHD	2.242 x 600 x 850	564	0 +8 °C	Stop	0,436 (1)	0,029	50/60 Hz	19089657	-
CCP-4S/R HHHH	2.242 x 600 x 850	564	0 +8 °C	Stop	0,436 (1)	0,029	50/60 Hz	19089658	-

(1) Evap. -10°C/ Cond. 45°C (6) Consult the manufacturer

Options

			CCP-2S/R HD (€)	CCP-2S/R HH (€)	CCP-3S/R HDD (€)	CCP-3S/R HHD (€)	CCP-3S/R HHH (€)	CCP-4S/R HDDD (€)	CCP-4S/R HHDD (€)	CCP-4S/R HHHD (€)	CCP-4S/R HHHH (€)
Panoramic opening	PO		-	-	0	-	-	0	0	-	-
No top	NT		0	0	0	0	0	0	0	0	0
No splash-back	NS		0	0	0	0	0	0	0	0	0
G type plug	Cl		0	0	0	0	0	0	0	0	0
Back in Stainless Steel	BS		0	0	0	0	0	0	0	0	0
Frame heater	FH		0	0	0	0	0	0	0	0	0

CONCEPT

600 Snack with sinks



CCP-3S/S

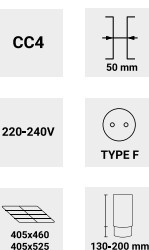

General characteristics

- Interior constructed with AISI-304 stainless steel exterior in food grade stainless steel.
- Heavy-duty stainless-steel working top with 100 mm high splash-back, preventing spillage behind the counter with 330x330x200 mm stamped bowl.
- Removable and height adjustable epoxy coated grids with a maximum loading capacity of up to 40 kg.
- Equipped with 1 grid 405x460 mm in each edge door and 1 grid 405x525 in centered doors and height adjustable 2 sets of tray slides per each full door.

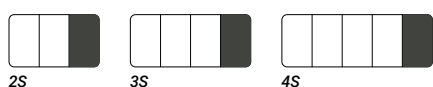

MODEL	DIMENSIONS (MM)	VOLUME (L)	TEMPERATURE (°C)	DEFROST	GAS	COOLING POWER (KW)	ELECTRIC POWER (KW)	ENERGY EFFICIENCY CLASS	ANNUAL CONSUMPTION (KWH)	FREQUENCY	REFERENCE	€
CCP-2S/S	1.492 x 600 x 850	268	0 +8 °C	Stop	R-600a	0,361 (1)	0,203	C	956 (4)	50 Hz	19089662	-
					R290	0,398 (1)	0,295	-	-	60 Hz	19090391	-
CCP-3S/S	2.017 x 600 x 850	416	0 +8 °C	Stop	R-600a	0,361 (1)	0,203	C	1.095 (4)	50 Hz	19089663	-
					R290	0,398 (1)	0,295	-	-	60 Hz	19090392	-
CCP-4S/S	2.542 x 600 x 850	564	0 +8 °C	Stop	R-600a	0,436 (1)	0,224	C	1.245 (4)	50 Hz	19089664	-
					R-600a	0,437 (1)	0,241	-	-	60 Hz	19090393	-
CCN-2S/S	1.492 x 600 x 850	268	-18 -22 °C	Electric	R290	0,364 (2)	0,319	D	2.121 (4)	50 Hz	19106964	-
					R290	0,381 (2)	0,389	-	-	60 Hz	19111008	-
CCN-3S/S	2.017 x 600 x 850	416	-18 -22 °C	Electric	R290	0,364 (2)	0,329	E	2.880 (4)	50 Hz	19106965	-
					R290	0,381 (2)	0,399	-	-	60 Hz	19111010	-

(1) Evap. -10°C/ Cond. 45°C (2) Evap. -25°C/ Cond. 45°C (4) According to EN22041 standard

Options

			CCP-2S/S (€)	CCP-3S/S (€)	CCP-4S/S (€)	CCN-2S/S (€)	CCN-3S/S (€)
Panoramic opening	PO		0	0	0	0	0
Left Group	LG		0	0	0	0	0
No splash-back	NS		0	0	0	0	0
1/2 + 1/2 Drawer	H		0	0	0	-	-
1/3 + 1/3 + 1/3 Drawer	T		0	0	0	-	-
2/3 + 1/3 Drawer	W		0	0	0	-	-
G type plug	CI		0	0	0	0	0
Lock	LC		0	0	0	0	0
Castors	C		0	0	0	0	0
Back in Stainless Steel	BS		0	0	0	0	0
Frame heater	FH		0	0	0	●	●

Standard Accessories

CODE	DESCRIPTION	2S	3S	4S	€	
19097777	Epoxy grid Snack 405x460	pc	2	2	2	-
19097775	Epoxy grid Snack 405x525	pc	-	1	2	-

Other Accessories

CODE	DESCRIPTION	€
19004925	Kit drawers 1/2+1/2 GN	-
19004921	Kit drawers 1/2+1/2 group side	-
19004930	Kit drawers 1/2+1/2 group side LG	-
19004927	Kit drawer 1/3+2/3	-
19004923	Kit drawers 1/3+1/3+1/3	-

CONCEPT

600 Snack display



CCP-3S GD

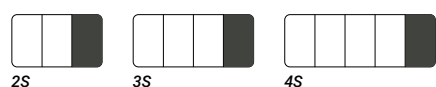
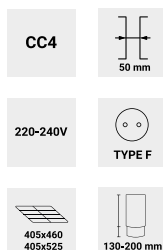

General characteristics

- Interior constructed with AISI-304 stainless steel exterior in food grade stainless steel.
- Heavy-duty stainless-steel working top with 100 mm high splash-back, preventing spillage behind the counter.
- Double-glazed doors insulated with low thermal emissivity to reduce heat transfer with ergonomic handle.
- Removable and height adjustable epoxy coated grids with a maximum loading capacity of up to 40 kg.
- Equipped with 1 grid 405x460 mm in each edge door and 1 grid 405x525 in centered doors and height adjustable 2 sets of tray slides per each full door.



MODEL	DIMENSIONS (MM)	VOLUME (L)	TEMPERATURE (°C)	DEFROST	GAS	COOLING POWER (KW)	ELECTRIC POWER (KW)	ENERGY EFFICIENCY CLASS	ANNUAL CONSUMPTION (KWH)	FREQUENCY	REFERENCE	€
CCP-2S GD	1.492 x 600 x 850	268	0 +8 °C	Stop	R-600a	0,361 (1)	0,207	C	1.379 (5)	50 Hz	19089659	-
					R290	0,398 (1)	0,299					-
CCP-3S GD	2.017 x 600 x 850	416	0 +8 °C	Stop	R-600a	0,361 (1)	0,209	C	1.536 (5)	50 Hz	19089660	-
					R290	0,398 (1)	0,301					-
CCP-4S GD	2.542 x 600 x 850	564	0 +8 °C	Stop	R-600a	0,436 (1)	0,232	D	1.808 (5)	50 Hz	19089661	-
					R-600a	0,437 (1)	0,249					-

(1) Evap. -10°C/ Cond. 45°C (5) According to EN23953 standard

Options

			CCP-2S GD (€)	CCP-3S GD (€)	CCP-4S GD (€)
Panoramic opening	PO		o	o	o
Left Group	LG		o	o	o
No top	NT		o	o	o
No splash-back	NS		o	o	o
G type plug	CI		o	o	o
Lock	LC		●	●	●
Castors	C		o	o	o
Back in Stainless Steel	BS		o	o	o
Frame heater	FH		o	o	o
Glass door	GD		●	●	●

Standard Accessories

CODE	DESCRIPTION		2S	3S	4S	€
19097777	Epoxy grid Snack 405x460	pc	2	2	2	-
19097775	Epoxy grid Snack 405x525	pc	-	1	2	-

Other Accessories

CODE	DESCRIPTION	€
19004925	Kit drawers 1/2+1/2 GN	-
19004921	Kit drawers 1/2+1/2 group side	-
19004930	Kit drawers 1/2+1/2 group side LG	-
19004927	Kit drawer 1/3+2/3	-
19004923	Kit drawers 1/3+1/3+1/3	-

CONCEPT

800 Pastry EN60x40



CCP-3B

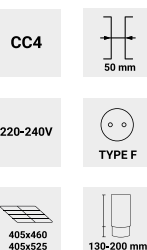

General characteristics

- Interior constructed with AISI-304 stainless steel exterior in food grade stainless steel.
- Heavy-duty stainless-steel working top with 100 mm high splash-back, preventing spillage behind the counter.
- Removable and height adjustable epoxy coated EN60x40 grids with a maximum loading capacity of up to 40 kg.
- Cooling system: Forced air refrigeration equipment with evaporator.

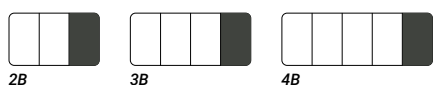

2B

3B

4B



MODEL	DIMENSIONS (MM)	VOLUME (L)	TEMPERATURE (°C)	DEFROST	GAS	COOLING POWER (KW)	ELECTRIC POWER (KW)	ENERGY EFFICIENCY CLASS	ANNUAL CONSUMPTION (KWH)	FREQUENCY	REFERENCE	€
CCP-2B	1.492 x 800 x 850	417	0 +8 °C	Stop	R290	0,369 (1)	0,262	D	1477 (4)	50 Hz	19102582	-
					R290	0,369 (1)	0,262	-	-	60 Hz	19103513	-
CCP-3B	2.017 x 800 x 850	612	0 +8 °C	Stop	R290	0,369 (1)	0,262	D	1723 (4)	50 Hz	19102583	-
					R290	0,369 (1)	0,262	-	-	60 Hz	19103514	-
CCP-4B	2.542 x 800 x 850	800	0 +8 °C	Stop	R290	0,593 (1)	0,387	E	2442 (4)	50 Hz	19102618	-
					R290	0,593 (1)	0,387	-	-	60 Hz	19103515	-

(1) Evap. -10°C/ Cond. 45°C (4) According to EN22041 standard





Options

			CCP-2B (€)	CCP-3B (€)	CCP-4B (€)
Panoramic opening	PO		o	o	o
Left Group	LG		o	o	o
No top	NT		o	o	o
No splash-back	NS		o	o	o
G type plug	Cl		o	o	o
Lock	LC		o	o	o
Remote Group	RG		o	o	o
Granite Top	GR		o	o	o
Castors	C		o	o	o
Back in Stainless Steel	BS		o	o	o
Frame heater	FH		o	o	o

Standard Accessories

	CODE	DESCRIPTION		2B	3B	4B	€
	19097776	EN60x40 Epoxy grid	pc	2	3	4	-
	19033557	Tray support guides L=649 mm	pc	4	6	8	-

Accessories

MODEL	REFERENCE	DESCRIPTION	WHERE USED	€
Door orientation kit				
 KDO-4-R	19098305	Door orientation kit right	All counters	-
 KDO-4-L	19098304	Door orientation kit left	All counters	-
Castors kit				
 KC-4 Ø80	19016846	Castor kit 4 (3b + 3wb)	2 and 3 body counters	-
 KC-6 Ø80	19011005	Castor kit 6 (3b + 3wb)	4 body counters	-
Connectivity kit				
 FagorKonnnect Foodservice	19111437	Kit Fagor Konnect - Refrigeration	Advance counters	-



Special tables
for specific tasks.

20

FAGOR

20

Preparation counters

— Features.....	317
— Configurable Pizza Counters	319
— Compact Pizza Counters.....	321
— Refrigerated work stations.....	323
— Saladettes	326
— Accessories	332

Special units or any variations from the standard model must be assembled at the factory at an additional charge over the standard model's price.

Please, contact Fagor Professional for any other variation or option that is not included on this list.

Characteristics

Wide range

Complete range of refrigerated preparation counters, constructed in 700 and 800mm depth with diverse worktop configurations (Stainless Steel, Granit, Polypropilene etc...).



Multiflow

Optimal air circulation system that guarantees a balanced and constant distribution throughout the equipment, so that the temperature remains uniform. It helps preserve food for longer.



ECO function

Function that optimizes the performance by automatically setting temperatures, when doors are not opened so that the cooling unit works only when needed and always, efficiently.



Integrated handles

Stainless steel doors with ergonomic, full-length, robust, perfectly integrated handle that ensures practical opening of the drawers and avoids dust and dirt collection.



Removable door gasket

Removable triple camera pull-out/push-in magnetic door gasket to keep maximum hygiene and maintain the insulating properties.





Electronic control Easy to use

Functional and intuitive electronic control with capacitive keyboard that allows direct access to main functions.



Maximum stability

Height-adjustable stainless steel legs as standard. Height of the legs can be adjusted individually. In addition, there is also the option to choose swivel wheels or legs for marine.

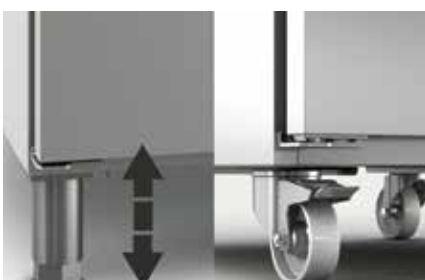

Telescopic sliding drawers

Stainless steel drawers with perforated bottom plates and telescopic sliding guides, capable of complete retraction, to economize working surface.



Guide and zippers system

Removable Stainless steel rack and guide system without use of tools which allows a proper distribution of products.



CONFIGURABLE PIZZA COUNTERS

700 GN 1/1



CC4

220-240V



TYPE F



GN 1/1



130-200 mm

General characteristics

- Specially manufactured in high-quality stainless-steel for intensive professional applications, featuring a very robust design and perfect finishing. Ideal to be used as a pizza preparation station when combined with pizza ingredient cases.
- Heavy-duty 30 mm granite working top with side and rear splash-back of 160 mm high, preventing spillage behind the counter.
- Removable and height adjustable epoxy coated GN 1/1 grids with a maximum loading capacity of up to 40 kg.

CCP-3G GR



2G



3G

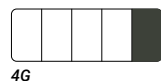

4G



MODEL	DIMENSIONS (MM)	VOLUME (L)	TEMPERATURE (°C)	DEFROST	GAS	COOLING POWER (KW)	ELECTRIC POWER (KW)	ENERGY EFFICIENCY CLASS	ANNUAL CONSUMPTION (KWH)	FREQUENCY	REFERENCE	€
CCP-2G GR	1.342 x 700 x 850	274	0 +8 °C	Stop	R-600a	0,361 (1)	0,203	B	610 (4)	50 Hz	19089668	-
					R290	0,398 (1)	0,295	-	-	60 Hz	19090403	-
CCP-3G GR	1.792 x 700 x 850	428	0 +8 °C	Stop	R-600a	0,361 (1)	0,203	C	1.095 (4)	50 Hz	19089669	-
					R290	0,398 (1)	0,295	-	-	60 Hz	19090404	-
CCP-4G GR	2.242 x 700 x 850	581	0 +8 °C	Stop	R-600a	0,436 (1)	0,224	C	1.245 (4)	50 Hz	19089670	-
					R-600a	0,437 (1)	0,241	-	-	60 Hz	19090405	-

(1) Evap. -10°C/ Cond. 45°C (2) Evap. -25°C/ Cond. 45°C (4) According to EN22041 standard

Options

			CCP-2G (€)	CCP-3G (€)	CCP-4G (€)
G type plug	CI		o	o	o
Panoramic opening	PO		o	o	o
Lock	LC		o	o	o
Left group	LG		o	o	o
Granite top	GR		●	●	●
2/3 + 1/3 Drawer	W		o	o	o
1/2 + 1/2 Drawer	H		o	o	o
1/3 + 1/3 + 1/3 Drawer	T		o	o	o
Back in Stainless Steel	BS		o	o	o
Frame heater	FH		o	o	o

Standard Accessories

	CODE	DESCRIPTION	2G	3G	4G	€	
	19097778	GN 1/1 epoxy grid	pc	2	3	4	-
	19014778	Tray support guides L=562 mm	pc	4	6	8	-

CONFIGURABLE PIZZA COUNTERS

800 EN 60x40



CCP-3B GR D4



CC4

220-240V

TYPE F

EN 60x40

130-200 mm

General characteristics

- Specially manufactured in high-quality stainless-steel for intensive professional applications, featuring a very robust design and perfect finishing. Ideal to be used as a pizza preparation station when combined with pizza ingredient cases.
- Heavy-duty 30 mm granite working top with side and rear splash-back of 160 mm high, preventing spillage behind the counter.
- Neutral compartment with drawers which incorporate euronorm size, sanitary PVC made baskets. Drawers are assembled over telescopic sliding guides, capable of complete retraction, to maximize storage capacity.
- Removable and height adjustable epoxy coated EN 60x40 grids with a maximum loading capacity of up to 40 kg.



MODEL	DIMENSIONS (MM)	VOLUME (L)	TEMPERATURE (°C)	DEFROST	GAS	COOLING POWER (KW)	ELECTRIC POWER (KW)	ENERGY EFFICIENCY CLASS	ANNUAL CONSUMPTION (KWH)	FREQUENCY	REFERENCE	€
CCP-2B GR	1.492 x 800 x 850	417	0 +8 °C	Stop	R290	0,369 (1)	0,262	D	1.477 (4)	50 Hz	19102651	-
					R290	0,369 (1)	0,262	-	-	60 Hz	19111012	-
CCP-3B GR	2.017 x 800 x 850	612	0 +8 °C	Stop	R290	0,369 (1)	0,262	D	1.723 (4)	50 Hz	19102652	-
					R290	0,369 (1)	0,262	-	-	60 Hz	19111013	-
CCP-4B GR	2.542 x 800 x 850	800	0 +8 °C	Stop	R290	0,593 (1)	0,387	E	2.442 (4)	50 Hz	19102653	-
					R290	0,593 (1)	0,387	-	-	60 Hz	19111014	-
CCP-2B GR D7	2.017 x 800 x 850	417	0 +8 °C	Stop	R290	0,369 (1)	0,262	D	1.478 (4)	50 Hz	19102754	-
					R290	0,369 (1)	0,262	-	-	60 Hz	19111016	-
CCP-3B GR D7	2.542 x 800 x 850	612	0 +8 °C	Stop	R290	0,369 (1)	0,262	D	1.723 (4)	50 Hz	19102782	-
					R290	0,369 (1)	0,262	-	-	60 Hz	19111018	-
CCP-2B GR D4	2.017 x 800 x 850	417	0 +8 °C	Stop	R290	0,369 (1)	0,262	D	1.478 (4)	50 Hz	19102722	-
					R290	0,369 (1)	0,262	-	-	60 Hz	19111020	-
CCP-3B GR D4	2.542 x 800 x 850	612	0 +8 °C	Stop	R290	0,369 (1)	0,262	D	1.723 (4)	50 Hz	19102759	-
					R290	0,369 (1)	0,262	-	-	60 Hz	19111021	-

(1) Evap. -10°C/ Cond. 45°C (2) Evap. -25°C/ Cond. 45°C (4) According to EN22041 standard

Options

			CCP-2B GR (€)	CCP-3B GR (€)	CCP-4B GR (€)	CCP-2B GR D7 (€)	CCP-3B GR D7 (€)	CCP-2B GR D4 (€)	CCP-3B GR D4 (€)
G type plug	CI		0	0	0	0	0	0	0
Panoramic opening	PO		0	0	0	0	0	0	0
Lock	LC		0	0	0	0	0	0	0
Remote Group	RG		0	0	0	0	0	0	0
Granite top	GR		●	●	●	●	●	●	●
Back in Stainless Steel	BS		0	0	0	0	0	0	0
Frame heater	FH		0	0	0	0	0	0	0

Standard Accessories

CODE	DESCRIPTION	2B	3B	4B	€	
19097776	EN 60x40 Epoxy grid	pc	2	3	4	-
19033557	Tray support guides L=649 mm	pc	4	6	8	-

CONFIGURABLE PIZZA COUNTERS

Ingredient vitrines for 700 GN 1/1 counters



SP-3G



SPT-3G

CC4

220-240V



TYPE F



GN 150 mm

General characteristics

- Specially manufactured in high-quality stainless-steel for intensive professional applications, featuring a very robust design and perfect finishing. Ideal as a container ingredient for pizzas, salads, and sandwiches.
- Two versions available:
 - Exterior constructed with tempered glass and anodized aluminum profiles.
 - Stainless steel hinged lid with operating position at 90°C.
- Static cooling system. Cold is generated through a copper coil located on the bottom plate of the vitrine.

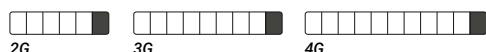

2G

3G

4G



MODEL	DIMENSIONS (mm)	CONTAINERS	QUANTITY	TEMPERATURE	GAS	COOLING POWER (kW)	ELECTRIC POWER (kW)	FREQUENCY	REFERENCE	€
Tempered glass cover										
SP-2G	1.340 x 336 x 450	GN1/4	5	+2 +8 °C	R-600a	0,169 (1)	0,102	50 Hz	19089671	-
					R290	0,299 (1)	0,17	60 Hz	19090406	-
SP-3G	1.790 x 336 x 450	GN1/4	8	+2 +8 °C	R-600a	0,169 (1)	0,102	50 Hz	19089672	-
					R290	0,299 (1)	0,17	60 Hz	19090408	-
SP-4G	2.240 x 336 x 450	GN1/4	11	+2 +8 °C	R-600a	0,169 (1)	0,102	50 Hz	19089673	-
					R290	0,299 (1)	0,17	60 Hz	19090410	-
Stainless steel lid case										
SPT-2G	1.340 x 336 x 250	GN1/4	5	+2 +8 °C	R-600a	0,169 (1)	0,102	50 Hz	19089676	-
					R290	0,299 (1)	0,17	60 Hz	19090411	-
SPT-3G	1.790 x 336 x 250	GN1/4	8	+2 +8 °C	R-600a	0,169 (1)	0,102	50 Hz	19089677	-
					R290	0,299 (1)	0,17	60 Hz	19090423	-
SPT-4G	2.240 x 336 x 250	GN1/4	11	+2 +8 °C	R-600a	0,169 (1)	0,102	50 Hz	19089678	-
					R290	0,299 (1)	0,17	60 Hz	19090425	-

(1) Evap. -10°C/ Cond. 45°C

Options

			SP-2G (€)	SP-3G (€)	SP-4G (€)	SPT-2G (€)	SPT-3G (€)	SPT-4G (€)
G Type plug	CI		0	0	0	0	0	0

Other Accessories

CODE	DESCRIPTION	€
19104386	GN 1/4 100 mm depth bowl	-
19106427	GN 1/4 150 mm depth bowl	-

CONFIGURABLE PIZZA COUNTERS

Ingredient vitrines for EN 60x40 counters



SP-3B



SPT-3B

CC4 220-240V

TYPE F GN 150 mm

General characteristics

- Specially manufactured in high-quality stainless-steel for intensive professional applications, featuring a very robust design and perfect finishing. Ideal as a container ingredient for pizzas, salads, and sandwiches.
- Two versions available:
 - Exterior constructed with tempered glass and anodized aluminum profiles.
 - Stainless steel hinged lid with operating position at 90°C.
- Static cooling system. Cold is generated through a copper coil located on the bottom plate of the vitrine.

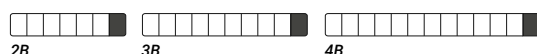

MODEL	DIMENSIONS (mm)	CONTAINERS	QUANTITY	TEMPERATURE	GAS	COOLING POWER (kW)	ELECTRIC POWER (kW)	FREQUENCY	REFERENCE	€
Tempered glass cover										
SP-2B	1.496 x 336 x 450	GN1/4	6	+2 +8 °C	R-600a	0,169 (1)	0,102	50 Hz	19089674	-
					R290	0,299 (1)	0,17	60 Hz	19090407	-
SP-3B	2.019 x 336 x 450	GN1/4	9	+2 +8 °C	R-600a	0,169 (1)	0,102	50 Hz	19089675	-
					R290	0,299 (1)	0,17	60 Hz	19090409	-
SP-4B	2.542 x 336 x 450	GN1/4	12	+2 +8 °C	R-600a	0,169 (1)	0,102	50 Hz	19096958	-
					R290	0,299 (1)	0,17	60 Hz	19111047	-
SP-2B GN 1/3	1.492 x 396 x 450	GN1/3	6	+2 +8 °C	R-600a	0,169 (1)	0,102	50 Hz	19096956	-
					R290	0,299 (1)	0,17	60 Hz	19111040	-
SP-3B GN 1/3	2.017 x 396 x 450	GN1/3	9	+2 +8 °C	R-600a	0,169 (1)	0,102	50 Hz	19096957	-
					R290	0,299 (1)	0,17	60 Hz	19111042	-
SP-4B GN 1/3	2.542 x 396 x 450	GN1/3	12	+2 +8 °C	R-600a	0,361 (1)	0,169	50 Hz	19096959	-
					R290	0,299 (1)	0,17	60 Hz	19111045	-
Stainless steel lid case										
SPT-2B	1.496 x 336 x 250	GN1/4	6	+2 +8 °C	R-600a	0,169 (1)	0,102	50 Hz	19089679	-
					R290	0,299 (1)	0,17	60 Hz	19090412	-
SPT-3B	2.019 x 336 x 250	GN1/4	9	+2 +8 °C	R-600a	0,169 (1)	0,102	50 Hz	19089680	-
					R290	0,299 (1)	0,17	60 Hz	19090424	-
SPT-4B	2.542 x 336 x 450	GN1/4	12	+2 +8 °C	R-600a	0,169 (1)	0,102	50 Hz	19096982	-
					R290	0,299 (1)	0,17	60 Hz	19111048	-
SPT-2B GN 1/3	1.492 x 396 x 450	GN1/3	6	+2 +8 °C	R-600a	0,169 (1)	0,102	50 Hz	19096980	-
					R290	0,299 (1)	0,17	60 Hz	19111041	-
SPT-3B GN 1/3	2.017 x 396 x 450	GN1/3	9	+2 +8 °C	R-600a	0,169 (1)	0,102	50 Hz	19096981	-
					R290	0,299 (1)	0,17	60 Hz	19111044	-
SPT-4B GN 1/3	2.542 x 396 x 450	GN1/3	12	+2 +8 °C	R-600a	0,361 (1)	0,169	50 Hz	19096983	-
					R290	0,299 (1)	0,17	60 Hz	19111046	-

Options

		SP-2B (€)	SP-3B (€)	SP-4B (€)	SPT-2B (€)	SPT-3B (€)	SPT-4B (€)
G Type plug	Cl	o	o	o	o	o	o

Other Accessories

	CODE	DESCRIPTION	€
	19104386	GN 1/4 100 mm depth bowl	-
	19106427	GN 1/4 150 mm depth bowl	-
	19104389	GN 1/3 100 mm depth bowl	-
	19106426	GN 1/3 150 mm depth bowl	-

REFRIGERATED WORK STATION

700 GN 1/1 for Pizza



CPZ-3G

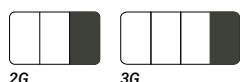

General characteristics

- Specially manufactured in high-quality stainless-steel for intensive professional applications, featuring a very robust design and perfect finishing. Ideal as a container ingredient for pizzas.
- Heavy-duty stainless-steel 50 mm working top with Built-in neutral unit designed to house 7 GN1/4 or GN1/3 containers in CPZ-2G and 9 in CPZ-3G with a maximum 100 mm depth (not included).
- Stainless steel hinged lid with opening position at 90°.
- Worktop ingredients bowls are refrigerated by the air circulation of the cooling unit. Location of evaporator in the middle beam and the correct isolation of the worktop ensures an uniform cold distribution.
- Removable and height adjustable epoxy coated GN 1/1 grids with a maximum loading capacity of up to 40 kg.

	MODEL	DIMENSIONS (MM)	CONTAINERS	QUANTITY	VOLUME (L)	TEMPERATURE (°C)	DEFROST	GAS	COOLING POWER (KW)	ELECTRIC POWER (KW)	FREQUENCY	REFERENCE	€
⊕ STOCK	CPZ-2G	1.350 x 708 x 850	GN1/3	7	290	0 +8 °C	Stop	R290	0,369 (1)	0,262	50 Hz	19089683	-
								R290	0,398 (1)	0,308	60 Hz	19089684	-
⊕ STOCK	CPZ-3G	1.800 x 708 x 850	GN1/3	9	445	0 +8 °C	Stop	R290	0,796 (1)	0,522	50 Hz	19089685	-
								R290	0,641 (1)	0,484	60 Hz	19089686	-
	CPZ-2G	1.350 x 708 x 850	GN1/4	7	290	0 +8 °C	Stop	R290	0,369 (1)	0,262	50 Hz	19096514	-
								R290	0,398 (1)	0,308	60 Hz	19111050	-
	CPZ-3G	1.800 x 708 x 850	GN1/4	10	445	0 +8 °C	Stop	R290	0,796 (1)	0,522	50 Hz	19096515	-
								R290	0,641 (1)	0,484	60 Hz	19111055	-

(1) Evap. -10°C/ Cond. 45°C

Container lay-out

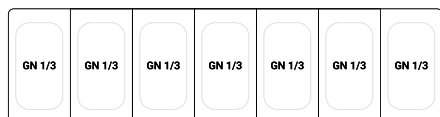

CPZ-2G GN 1/3

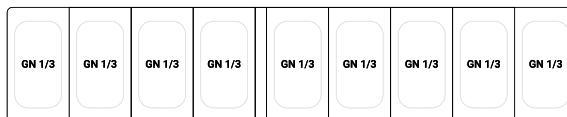

CPZ-3G GN 1/3

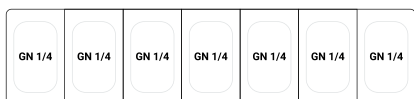

CPZ-2G GN 1/4

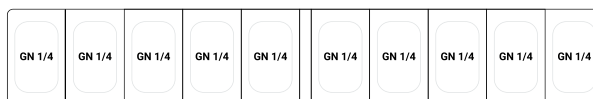

CPZ-3G GN 1/4

Options

			CPZ-2G (€)	CPZ-3G (€)
G type plug	CI		0	0
Panoramic opening	PO		0	0
Lock	LC		0	0
Castors	C		0	0
Remote group	RG		0	0
1/2 + 1/2 Drawer	H		0	0
1/3 + 1/3 + 1/3 Drawer	T		0	0
Back in Stainless Steel	BS		0	0
Frame heater	FH		0	0

Standard Accessories

	CODE	DESCRIPTION	2G	3G	€
	19097778	GN 1/1 epoxy grid	2	3	-
	19014778	Tray support guides L=562 mm	4	6	-

Other Accessories

	CODE	DESCRIPTION	€
	19104386	GN 1/4 100 mm depth bowl	-
	19106427	GN 1/4 150 mm depth bowl	-
	19104389	GN 1/3 100 mm depth bowl	-
	19106426	GN 1/3 150 mm depth bowl	-

REFRIGERATED WORK STATION

800 EN 60x40 for Pizza



CPZ-3B

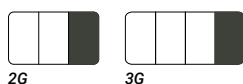

2G

3G

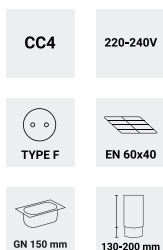

General characteristics

- Specially manufactured in high-quality stainless-steel for intensive professional applications, featuring a very robust design and perfect finishing. Ideal as a container ingredient for pizzas.
- Heavy-duty stainless-steel 50 mm working top with Built-in neutral unit designed to house 8 GN1/4 or GN1/3 containers in CPZ-2B and 10 in CPZ-3B with a maximum 100 mm depth (not included).
- Stainless steel hinged lid with opening position at 90°.
- Worktop ingredients vitrines are refrigerated by the air circulation of the cooling unit. Location of evaporator in the middle beam and the correct isolation of the worktop ensures an uniform cold distribution.
- Removable and height adjustable epoxy coated EN60x40 grids with a maximum loading capacity of up to 40 kg.

MODEL	DIMENSIONS (MM)	CONTAINERS	QUANTITY	VOLUME (L)	TEMPERATURE (°C)	DEFROST	GAS	COOLING POWER (KW)	ELECTRIC POWER (KW)	FREQUENCY	REFERENCE	€
CPZ-2B	1.495 x 808 x 1.055	GN1/3	7	470	0 +8 °C	Stop	R290	0,369 (1)	0,262	50 Hz	19102515	-
							R290	0,369 (1)	0,262	60 Hz	19111052	-
CPZ-3B	2.018 x 808 x 850	GN1/3	10	685	0 +8 °C	Stop	R290	0,796 (1)	0,522	50 Hz	19102562	-
							R290	0,796 (1)	0,522	60 Hz	19111056	-
CPZ-2B	1.495 x 808 x 1.055	GN1/4	8	470	0 +8 °C	Stop	R290	0,369 (1)	0,262	50 Hz	19102518	-
							R290	0,369 (1)	0,262	60 Hz	19111054	-
CPZ-3B	2.018 x 808 x 850	GN1/4	11	685	0 +8 °C	Stop	R290	0,796 (1)	0,522	50 Hz	19102565	-
							R290	0,796 (1)	0,522	60 Hz	19111057	-

Container lay-out

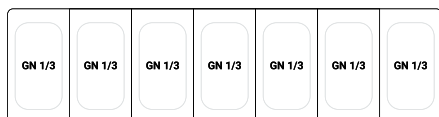

CPZ-2B GN 1/3

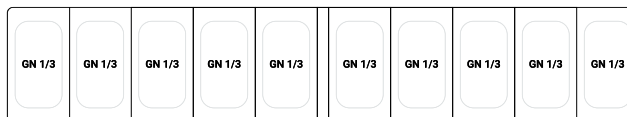

CPZ-3B GN 1/3

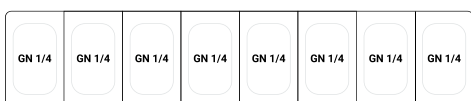

CPZ-2B GN 1/4

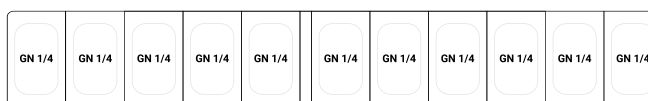

CPZ-3B GN 1/4

Options

			CPZ-2B (€)	CPZ-3B (€)
G type plug	Cl		o	o
Panoramic opening	PO		o	o
Lock	LC		o	o
Castors	C		o	o
Remote group	RG		o	o
Back in Stainless Steel	BS		o	o
Frame heater	FH		o	o

Standard Accessories

CODE	DESCRIPTION	2B	3B	€
19097776	EN 60x40 epoxy grid	2	3	-
19033557	Tray support guides L=649 mm	4	6	-

Other Accessories

CODE	DESCRIPTION	€
19104386	GN 1/4 100 mm depth bowl	-
19106427	GN 1/4 150 mm depth bowl	-
19104389	GN 1/3 100 mm depth bowl	-
19106426	GN 1/3 150 mm depth bowl	-

Compact Pizza Counters



CPZC-3G

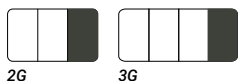

CC4

220-240V



TYPE F



EN 60x40



GN 150 mm



130-200 mm

General characteristics

- Specially manufactured in high-quality stainless-steel for intensive professional applications, featuring a very robust design and perfect finishing. Ideal to be used as a pizza preparation counter.
- Heavy-duty 30 mm granite working top with 88mm height splashback and a cutout to place 100 mm GN 1/6 bowls. 6 in CPZC-2G and 8 in CPZC-3G (not included).
- Worktop ingredients vitrines are refrigerated by the air circulation of the cooling unit. Location of evaporator in the middle beam and the correct isolation of the worktop ensures an uniform cold distribution.
- Additional neutral compartment with 3 drawers EN 60x40 size.
- Removable and height adjustable epoxy coated EN 60x40 grids with a maximum loading capacity of up to 40 kg.



MODEL	DIMENSIONS (MM)	CONTAINERS	QUANTITY	VOLUME (L)	TEMPERATURE (°C)	DEFROST	GAS	COOLING POWER (KW)	ELECTRIC POWER (KW)	FREQUENCY	REFERENCE	€
CPZC-2G	1.590 x 700 x 880	GN1/4	6	325	0 +8 °C	Stop	R290	0,369 (1)	0,262	50 Hz	19089681	-
							R290	0,398 (1)	0,308	60 Hz	19090434	-
CPZC-3G	2.110 x 700 x 1.163	GN1/4	8	480	0 +8 °C	Stop	R290	0,369 (1)	0,262	50 Hz	19089682	-
							R290	0,398 (1)	0,308	60 Hz	19090435	-

(1) Evap. -10°C/ Cond. 45°C

Options

			CPZC-2G (€)	CPZC-3G (€)
G type plug	CI		0	0
Panoramic opening	PO		0	0
Lock	LC		0	0
Remote group	RG		0	0
Granite top	GR		●	●
Back in Stainless Steel	BS		0	0
Frame heater	FH		0	0

Standard Accessories

	CODE	DESCRIPTION	2G	3G	€
	19097776	EN 60x40 epoxy grid	2	3	-
	19014778	Tray support guides L=562 mm	4	6	-

Other Accessories

	CODE	DESCRIPTION	€
	19104382	GN 1/6 65 mm depth bowl	-
	19104383	GN 1/6 100 mm depth bowl	-

SALADETTE

Solid worktop saladettes



CC4	220-240V
TYPE F	GN 1/1

General characteristics

- Specially manufactured in high-quality stainless-steel for intensive professional applications.
- 30 mm CFC free polyurethane injected stainless Steel worktop without splashback.
- Stainless steel drawers with perforated bottom plates and telescopic sliding guides, capable of complete retraction, to economize working surface. Other drawer configurations are also available upon request.
- Static evaporator, foamed in CFC free high-density polyurethane with 40 mm thickness. Interior without fin evaporator and smooth surfaces make an easy to clean compartment.
- Forced air cooling system.
- Removable front panel with front breathing design allowing machine to be embedded without penalizing performance.
- Removable and height adjustable epoxy coated GN 1/1 grids with a maximum loading capacity of up to 40 kg.



	MODEL	DIMENSIONS (MM)	VOLUME (L)	TEMPERATURE (°C)	DEFROST	GAS	COOLING POWER (KW)	ELECTRIC POWER (KW)	ENERGY EFFICIENCY CLASS	ANNUAL CONSUMPTION (KWH)	FREQUENCY	REFERENCE	€
⊙ STOCK	RPS-2G	894 x 700 x 850	155	+2 +8 °C	Stop	R290	0,369 (1)	0,245	D	1.403 (4)	50/60 Hz	19105458	-
⊙ STOCK	RPS-3G	1.358 x 700 x 850	232	+2 +8 °C	Stop	R290	0,369 (1)	0,267	D	1.608 (4)	50/60 Hz	19105459	-

(1) Evap. -10°C/ Cond. 45°C (4) According to EN22041 standard

Options

			RPS-2G (€)	RPS-3G (€)
G type plug	CI		o	o
Panoramic opening	PO		●	●
Remote group	RG		o	o
1/2 + 1/2 Drawer	H		o	o

Standard Accessories

	CODE	DESCRIPTION	2G	3G	€
	19104363	GN 1/1 epoxy grid for saladette	2	3	-
	19014778	Tray support guides L=562 mm	2	3	-

SALADETTE

Polyethylene worktop saladettes

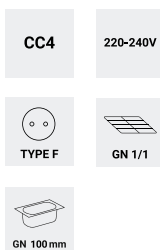

General characteristics

- Specially manufactured in high-quality stainless-steel for intensive professional applications.
- Open worktop suitable for GN container and removable high density polyethylene worktop surface suitable for handling food. Tylting lid with opening fix position.
- Stainless steel drawers with perforated bottom plates and telescopic sliding guides, capable of complete retraction, to economize working surface. Other drawer configurations are also available upon request.
- Static evaporator, foamed in CFC free high-density polyurethane with 40 mm thickness. Interior without fin evaporator and smooth surfaces make an easy to clean compartment.
- Forced air cooling system.
- Removable front panel with front breathing design allowing machine to be embedded without penalizing performance.
- Removable and height adjustable epoxy coated GN 1/1 grids with a maximum loading capacity of up to 40 kg.



MODEL	DIMENSIONS (mm)	VOLUME (L)	TEMPERATURE	DEFROST	GAS	COOLING POWER (kW)	ELECTRIC POWER (kW)	FREQUENCY	REFERENCE	€
RPS-2GP	894 x 700 x 861	155	+2 +8 °C	Stop	R290	0,369 (1)	0,245	50/60 Hz	19105614	-
RPS-3GP	1.358 x 700 x 861	232	+2 +8 °C	Stop	R290	0,369 (1)	0,267	50/60 Hz	19105067	-

(1) Evap. -10°C/ Cond. 45°C

Options

			RPS-2GP (€)	RPS-3GP (€)
G type plug	CI		0	0
Panoramic opening	PO		●	●
Remote group	RG		0	0
1/2 + 1/2 Drawer	H		0	0

Standard Accessories

CODE	DESCRIPTION	2G	3G	€
19104363	GN 1/1 epoxy grid for saladette	2	3	-
19014778	Tray support guides L=562 mm	2	3	-

Other Accessories

CODE	DESCRIPTION	€
GN Bowls		
19104382	GN 1/6 65 mm depth bowl	-
19104383	GN 1/6 100 mm depth bowl	-
19104384	GN 1/4 40 mm depth bowl	-
19104385	GN 1/4 65 mm depth bowl	-
19104386	GN 1/4 100 mm depth bowl	-
19106427	GN 1/4 150 mm depth bowl	-
19104387	GN 1/3 40 mm depth bowl	-
19104388	GN 1/3 65 mm depth bowl	-
19104389	GN 1/3 100 mm depth bowl	-
19106426	GN 1/3 150 mm depth bowl	-
19104390	GN 1/2 40 mm depth bowl	-
19104391	GN 1/2 65 mm depth bowl	-
19104392	GN 1/2 100 mm depth bowl	-
19048493	GN 1/1 40 mm depth bowl	-
19048494	GN 1/1 65 mm depth bowl	-
19048495	GN 1/1 100 mm depth bowl	-
Kits supports for GN bowls		
19104364	Kit support for GN1/6	-
19104365	Kit support for GN1/3 + GN1/6	-
19104366	Kit support for GN1/6	-
19104367	Kit support for GN1/4	-
19104368	Kit support for GN1/3	-
19104369	Kit support for GN1/2	-

Container lay-out

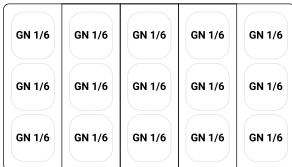

RPS-2GP GN 1/6

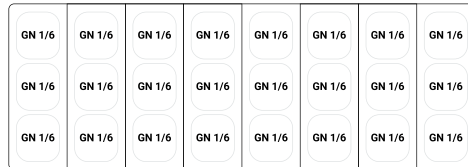

RPS-3GP GN 1/6

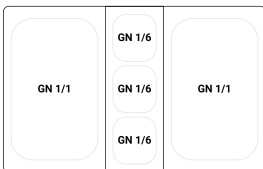

RPS-2GP GN 1/1 + 1/6



RPS-3GP GN 1/2

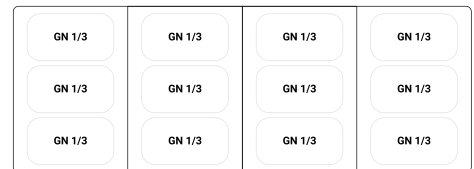

RPS-3GP GN 1/3

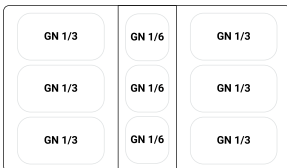

RPS-2GP GN 1/3 + 1/6

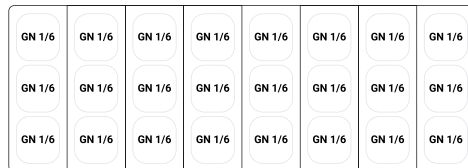

RPS-3GP GN 1/6

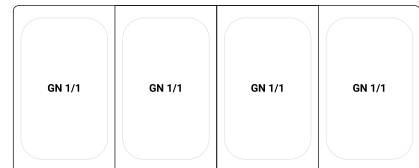

RPS-3GP GN 1/1

SALADETTE

Pizza worktop saladettes



RPS-3GZ

RPS-2GZ

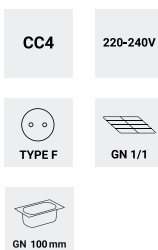

General characteristics

- Specially manufactured in high-quality stainless-steel for intensive professional applications.
- 30 mm CFC free polyurethane injected stainless Steel worktop with open area for GN1/6 containers.
- Stainless steel drawers with perforated bottom plates and telescopic sliding guides, capable of complete retraction, to economize working surface. Other drawer configurations are also available upon request.
- Static evaporator, foamed in CFC free high-density polyurethane with 40 mm thickness. Interior without fin evaporator and smooth surfaces make an easy to clean compartment.
- Forced air cooling system.
- Removable front panel with front breathing design allowing machine to be embedded without penalizing performance.
- Removable and height adjustable epoxy coated GN 1/1 grids with a maximum loading capacity of up to 40 kg.



	MODEL	DIMENSIONS (mm)	CONTAINERS	QUANTITY	VOLUME (L)	TEMPERATURE	DEFROST	GAS	COOLING POWER (kW)	ELECTRIC POWER (kW)	FREQUENCY	REFERENCE	€
◎STOCK	RPS-2GZ	894 x 700 x 955	GN1/6	5	155	+2 +8 °C	Stop	R290	0,369 (1)	0,245	50/60 Hz	19105615	-
◎STOCK	RPS-3GZ	1.358 x 700 x 955	GN1/6	8	232	+2 +8 °C	Stop	R290	0,369 (1)	0,267	50/60 Hz	19105611	-

(1) Evap. -10°C/ Cond. 45°C

Container lay-out



RPS-2GZ



RPS-3GZ

Options

			RPS-2GZ (€)	RPS-3GZ (€)
G type plug	CI		0	0
Panoramic opening	PO		●	●
Remote group	RG		0	0
1/2 + 1/2 Drawer	H		0	0

Standard Accessories

	CODE	DESCRIPTION	2G	3G	€
	19104363	GN 1/1 epoxy grid for saladette	2	3	-
	19014778	Tray support guides L=562 mm	2	3	-

Other Accessories

	CODE	DESCRIPTION	€
	19104382	GN 1/6 65 mm depth bowl	-
	19104383	GN 1/6 100 mm depth bowl	-

SALADETTE

Sandwich worktop saladettes



CC4	220-240V
TYPE F	GN 1/1
GN 100mm	

General characteristics

- Specially manufactured in high-quality stainless-steel for intensive professional applications.
- Heavy duty 30mm Granit built worktop with an open space suitable for GN 1/6 containers.
- Stainless steel drawers with perforated bottom plates and telescopic sliding guides, capable of complete retraction, to economize working surface. Other drawer configurations are also available upon request.
- Static evaporator, foamed in CFC free high-density polyurethane with 40 mm thickness. Interior without fin evaporator and smooth surfaces make an easy to clean compartment.
- Forced air cooling system.
- Removable front panel with front breathing design allowing machine to be embedded without penalizing performance.
- Removable and height adjustable epoxy coated GN 1/1 grids with a maximum loading capacity of up to 40 kg.



MODEL	DIMENSIONS (mm)	CONTAINERS	QUANTITY	VOLUME (L)	TEMPERATURE	DEFROST	GAS	COOLING POWER (kW)	ELECTRIC POWER (kW)	FREQUENCY	REFERENCE	€
RPS-2GS	894 x 700 x 1.140	GN1/6	5	155	+2 +8 °C	Stop	R290	0,369 (1)	0,245	50/60 Hz	19105616	-
RPS-3GS	1.358 x 700 x 1.140	GN1/6	8	232	+2 +8 °C	Stop	R290	0,369 (1)	0,267	50/60 Hz	19105617	-

(1) Evap. -10°C/ Cond. 45°C

Container lay-out



RPS-2GS



RPS-3GS

Options

			RPS-2GS (€)	RPS-3GS (€)
G type plug	CI		0	0
Panoramic opening	PO		●	●
Remote group	RG		0	0
1/2 + 1/2 Drawer	H		0	0

Standard Accessories

	CODE	DESCRIPTION	2G	3G	€
	19104363	GN 1/1 epoxy grid for saladette	2	3	-
	19014778	Tray support guides L=562 mm	2	3	-

Other Accessories

	CODE	DESCRIPTION	€
	19104382	GN 1/6 65 mm depth bowl	-
	19104383	GN 1/6 100 mm depth bowl	-

SALADETTE

Compact pizza saladettes

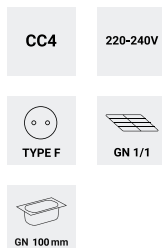

General characteristics

- Specially manufactured in high-quality stainless-steel for intensive professional applications.
- Heavy-duty 30mm granite working top with side splash-back with 160 mm height.
- Stainless steel drawers with perforated bottom plates and telescopic sliding guides, capable of complete retraction, to economize working surface. Other drawer configurations are also available upon request.
- Static evaporator, foamed in CFC free high-density polyurethane with 40 mm thickness. Interior without fin evaporator and smooth surfaces make an easy to clean compartment.
- Forced air cooling system.
- Removable front panel with front breathing design allowing machine to be embedded without penalizing performance.
- Removable and height adjustable epoxy coated GN 1/1 grids with a maximum loading capacity of up to 40 kg.
- Available to fit ingredient vitrines range. Compatible models:
 - SP-2G, 5 x GN1/4
 - SPT-2G, 5 x GN1/4



MODEL	DIMENSIONS (mm)	VOLUME (L)	TEMPERATURE	DEFROST	GAS	COOLING POWER (kW)	ELECTRIC POWER (kW)	ANNUAL CONSUMPTION (KWH)	ENERGY EFFICIENCY CLASS	FREQUENCY	REFERENCE	€
RPS-2G D6 GR	1.358 x 700 x 1.010	155	+2 +8 °C	Stop	R290	0,369 (1)	0,245	D	1.403 (4)	50/60 Hz	19104297	-
RPS-3G GR	1.358 x 700 x 1.010	232	+2 +8 °C	Stop	R290	0,369 (1)	0,267	D	1.608 (4)	50/60 Hz	19105613	-







Options

			RPS-2G D6 GR (€)	RPS-3G GR (€)
G type plug	CI		o	o
Panoramic opening	PO		●	●
Remote group	RG		o	o
1/2 + 1/2 Drawer	H		o	o

Standard Accessories

	CODE	DESCRIPTION	2G	3G	€
	19104363	GN 1/1 epoxy grid for saladette	2	3	-
	19014778	Tray support guides L=562 mm	2	3	-

Accessories

	MODEL	REFERENCE	DESCRIPTION	WHERE USED	€
Door orientation kit					
	KDO-4-R	19098305	Door orientation kit right	All preparation counters	-
	KDO-4-L	19098304	Door orientation kit left	All preparation counters	-
Drawers kit					
	KR-CG-1/2+1/2	19010993	Kit drawers 1/2+1/2	GN 1/1 preparation counters	-
	KR-CG-1/2+1/2 G	19015952	Kit drawers 1/2+1/2 group side	GN 1/1 preparation counters	-
	KR-CG-1/2+1/2 LG	19036401	Kit drawers 1/2+1/2 group side lg	GN 1/1 preparation counters	-
	KR-CG-1/3+1/3+1/3	19015954	Kit drawers 1/3+1/3+1/3	GN 1/1 preparation counters	-
	KR-CG-1/3+2/3	19015953	Kit drawer 1/3+2/3	GN 1/1 preparation counters	-
	KR-SA-1/2+1/2	19106089	Kit drawers 1/2+1/2 saladettes	Saladettes	-



Safe, effective and
respectful chilling with
your food.

Blast chillers

—Why use a blast chiller?.....	335
—Features	337
—Advance Blast chillers.....	339
—Concept Blast chillers	340
—Cook&Chill Blast chillers	341
—Roll-in Blast chillers.....	343

Blast chillers

Why use a blast chiller?

1. Hygiene and safety

All fresh organic food products contain a natural bacterial load which, in favourable ambient conditions (temperature and humidity), multiplies producing hazardous effects on consumer health.

Between +65°C and +3°C: in this temperature range, bacterial multiplication is accelerated exponentially.

Blast chilling means lowering the temperature of the product from +90°C to +3°C in less than 90 minutes. Passing through the critical temperature range between so fast where effects of harmful bacteria are disabled.

Blast chilling cooked product not only prevents bacterial proliferation but also prolongs product conservation time, avoiding loss of flavor and aroma.

The quality of the food is not affected, enlarging product storing time.

2. Work streamlining

Blast chillers allow a large quantity of product to be prepared and, once blast chilled, it can be consumed within a period of 5-7 day, while frozen product duration can extend to several months, maintaining organoleptic condition of the food.

The preservation of product quality, allows advance planning of kitchen work, improving raw ingredients purchase, as well as work load with advantages in terms of hygiene and menu variety.

3. Time savings

The advance preparation of foods and blast chilling of them allows kitchens to offer a more delicious and varied menu when required. The chef does not have to constantly oversee the process of preparing several dishes.

The simple operation of reheating the food allows a wide range of dishes to be served within a short period of time.

Blast chillers increase production capacity, thereby reducing staff costs and providing outstanding advantages in terms of profitability and time.

4. Quality

The rapid reduction in temperature makes it possible to conserve food moisture content and prevent normal bacterial proliferation.

Fast freezing encourages the formation of intercellular microcrystal, which maintain the compactability, flavour and freshness characteristics of foods over time.

Fagor Professional blast chillers are also exceptional at preserving fresh and raw foods, such as fish, crustaceans, vegetables, bread and partially-finished products such as fresh pasta and sauces.

5. Applications

This kitchen work streamlining system is highly advantageous for all types of catering and especially for canteens, hospitals and restaurants, as well as for special occasions such as large banquets.

It also allows to all kind of restaurants and catering business to offer their well-presented dishes which are ready to eat.

6. Other advantages

Blast chillers optimize stock management by:

- Reductions in lost weight due to the natural evaporation of moisture from cooked food
- Planned food purchases, thereby improving kitchen stock organisation
- Organization of storage capacities and work load, adjusting capable personal attention
- Drastic reductions in waste and unused food

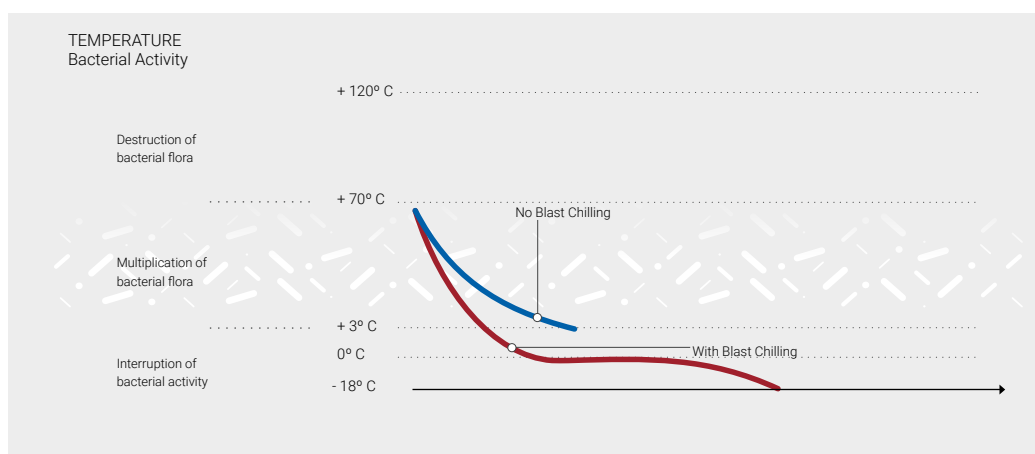

Blast chilling

SOFT CYCLE (STANDARD) - 90'

The right cycle for small size, light, fine food.

STRONG CYCLE (INTENSIVE) - 90'

Recommended for high density or large size food, as well as for packed food.

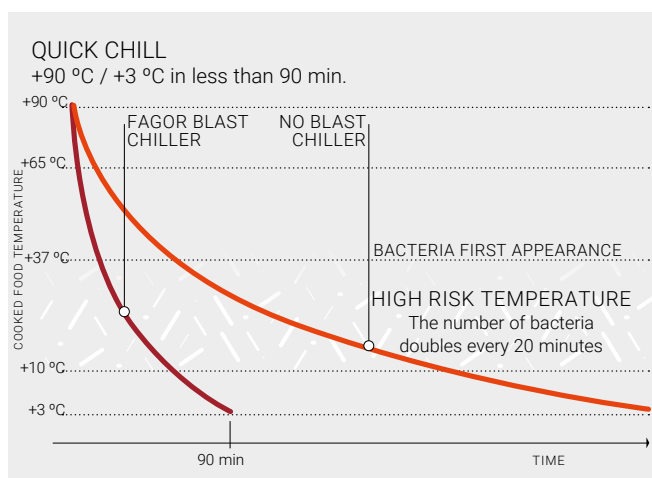

Blast freezing

SOFT CYCLE (STANDARD) - 240'

This is a cycle to freeze food with an even temperature and is therefore suitable for food that is to be cooled consistently and without sharp temperature changes or when cooked with different ingredients.

STRONG CYCLE (INTENSIVE) - 240'

This is the ideal cycle to freeze half cooked food or semi-prepared dishes. It is also suitable for raw food. It allows you to keep frozen food for a long time.

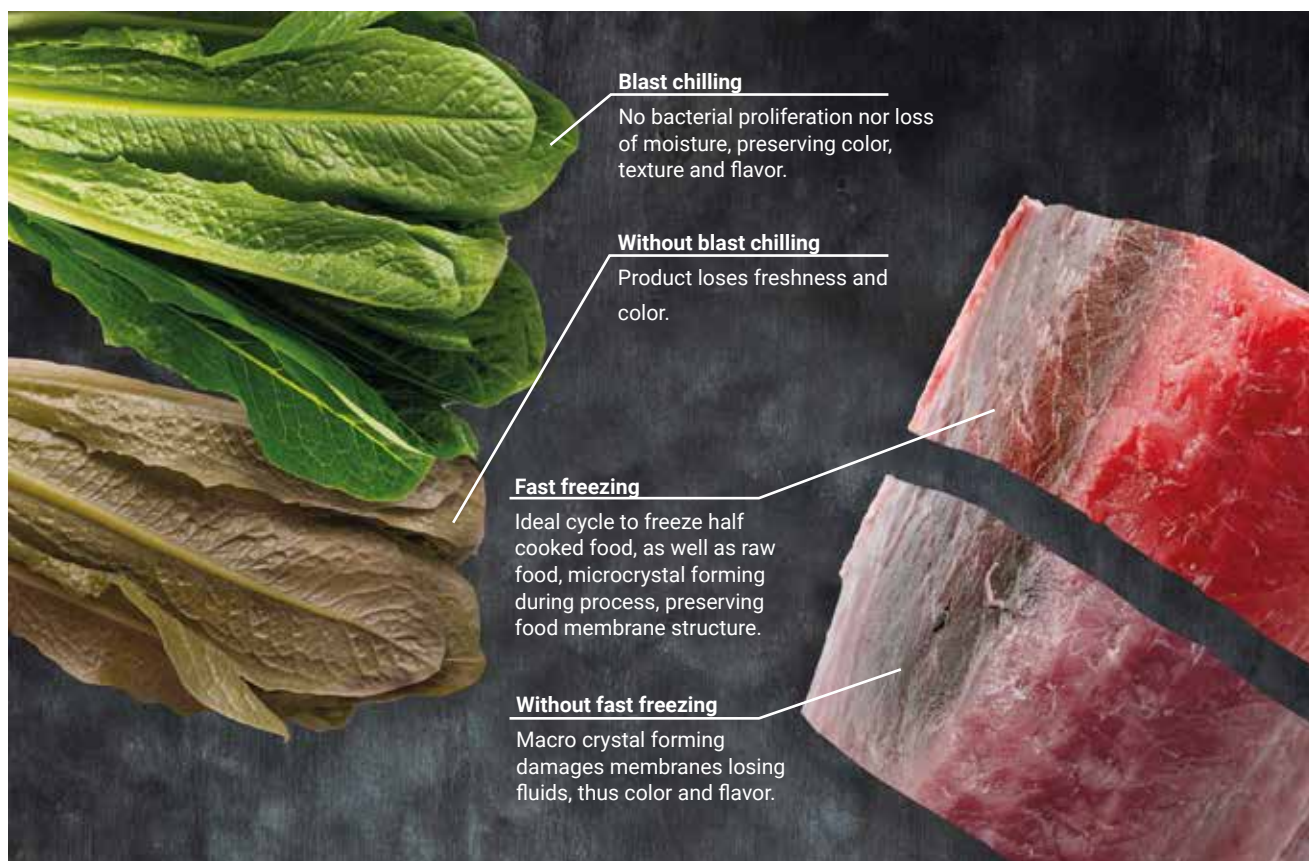
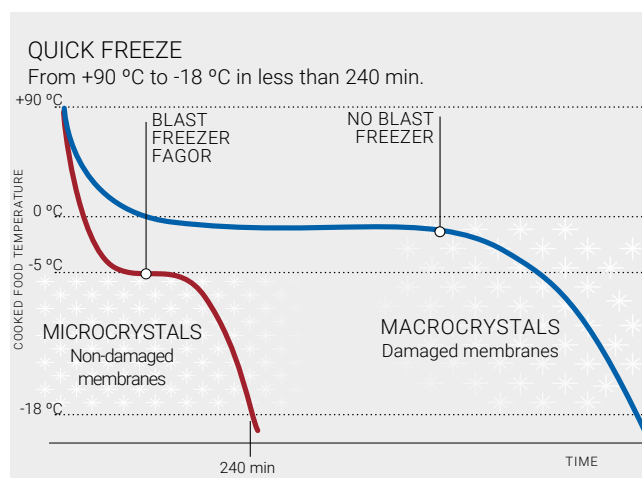

Features



	ADVANCE	CONCEPT
Insulation (mm)	60	60
Refrigerant + / -	R290 / R452a	R290
Climate class	5	5
Chilling cycle	Yes	Yes
Freezing cycle	Yes	Yes
Hard mode	Yes	Yes
Soft mode	Yes	Yes
HACCP compliant	Yes	Yes
Special cycles		
Fish canitization	Yes	Yes
Ice cream hardening	Yes	Yes
Pre-cooling	Yes	Yes
Drying	Yes	No
Heated prove	Standard	Optional
Ventilation control	Yes	No
Recipee Book by Fagor	Yes	No

Electronic control



Automatic closing door

Functional and intuitive electronic control with capacitive keyboard that allows direct access to main functions.



Pivotable Evaporator Cover

Function that optimizes the performance by automatically setting temperatures, when doors are not opened so that the cooling unit works only when needed and always, efficiently.





COOK & CHILL

ROLL-IN

60

100

R290 / R452a

R452a

5

5

Yes

Yes

Yes

Yes

Yes

Yes

Yes

Yes

Yes

Yes

Yes

Yes

Yes

Yes

Yes

Yes

Yes

Yes

Standard

Standard

Yes

Yes

Yes

Yes



Multipurpose rack

The embedded tray guides facilitate cleaning in the cabinets. They also increase storage flexibility, allowing it to be adapted to the user's needs.



Needle probe

The low energy consumption LED lights, strategically located on the sides, provide optimal illumination of the entire compartment.



Blast chillers



ABC-102

ABC-101 HC

ABC-051 HC

ABC-031 HC



General characteristics

- Intuitive 5" Screen touch electronic control placed in the door for more ergonomic use.
- Manual chilling process by time or probe control, both of them adjustable in each cycle as well as the evaporator fan ventilation adjustment in 5 different levels.
- 2 manual chilling modes:
 - Hard cycle: Default freezing cycle. Executes the cycle and maintains a constant temperature of -20°C.
 - Soft cycle: Default refrigeration cycle. Executes an initial cycle and maintains a constant temperature of 0°C.
- 96 preset chilling programmes by Fagor, divided in 8 food categories.
- Possibility to create a personalized cook book with up to 40 self made recipes.
- Additional cycles (Pre-Cooling, Continuous cycle, manual defrost, fish sanitization, ice cream hardening, Drying).
- Storing capacity for GN1/1 and EN 60x40 trays with 65 mm distance among them.



MODEL	DIMENSIONS (MM)	ELECTRIC CONNECTION	CAPACIDAD			PRODUCTION		GAS	COOLING POWER (KW)	ELECTRIC POWER (KW)	FREQUENCY	REFERENCE	€
			GN1/1	EN60X40	GN2/1	COOLING	FREEZING						
ABC-031 HC	590 x 700 x 520	220-240V	3	3	-	12	6	R290	0,565 (2)	0,41	50 Hz	19089755	-
									0,565 (2)	0,41	60 Hz	19108790	-
ABC-051 HC	790 x 700 x 850	220-240V	5	5	-	40	24	R290	0,71 (2)	0,713	50 Hz	19099866	-
									0,71 (2)	0,713	60 Hz	19111022	-
ABC-081 HC	790 x 800 x 1.290	220-240V	8	8	-	60	40	R290	1,18 (2)	0,713	50 Hz	19105085	-
									1,18 (2)	0,713	60 Hz	19111023	-
ABC-101 HC	790 x 800 x 1.420	220-240V	10	10	-	100	65	R290	1,62 (2)	1,426	50 Hz	19099947	-
									1,62 (2)	1,426	60 Hz	19111024	-
ABC-121	790 x 800 x 1.600	220-240V	12	12	-	12	6	R452a	1,3 (2)	2	50 Hz	19089765	-
									1,3 (2)	2	60 Hz	19089766	-
ABC-161	790 x 800 x 1.950	380-415V	16	16	-	23	13	R452a	2,85 (2)	3,5	50 Hz	19089767	-
									2,85 (2)	3,5	60 Hz	19089768	-
ABC-102	1.200 x 1.090 x 1.766	380-415V	-	20	20	40	24	R452a	4,079 (2)	2,947	50 Hz	19089769	-
									4,079 (2)	2,947	60 Hz	19089770	-

(2) Evap. -25°C/ Cond. 45°C

Options

			ABC-031 HC (€)	ABC-051 HC (€)	ABC-081 HC (€)	ABC-101 HC (€)	ABC-121 (€)	ABC-161 (€)	ABC-102 (€)
G type plug	Cl		0	0	0	0	0	0	-
Opposite opening	OP		-	0	0	0	0	0	-
Castors	C		-	0	0	0	0	0	0
Heated probe	Heat-P		•	•	•	•	•	•	•
USB	USB		0	0	0	0	0	0	0

CONCEPT

Blast chillers



CBC-101 HC

CBC-81 HC

CBC-51 HC

CBC-31 HC



General characteristics

- Intuitive 2,8" capacitive electronic control with chilling and freezing cycles which can be controlled by time or by temperature.
- 2 manual chilling modes:
 - Hard cycle: Default freezing cycle. Executes the cycle and maintains a constant temperature of -20°C.
 - Soft cycle: Default refrigeration cycle. Executes an initial cycle and maintains a constant temperature of 0°C.
- 3 additional cycles for pre-cooling, fish sanitization and ice-cream hardening and capacity to store 20 customized recipes.
- Capacity to store up to 20 personalized recipes.
- Storing capacity for GN1/1 and EN 60x40 trays with 65 mm distance among them.



	MODEL	DIMENSIONS (MM)	ELECTRIC CONNECTION	CAPACITY		PRODUCTION		GAS	COOLING POWER (KW)	ELECTRIC POWER (KW)	FREQUENCY	REFERENCE	€
				GN1/1	EN60X40	COOLING	FREEZING						
Ø STOCK	CBC-031 HC	590 x 700 x 520	220-240V	3	3	12	6	R290	0,565 (2)	0,41	50 Hz	19101748	-
									0,565 (2)	0,41	60 Hz	19108800	-
Ø STOCK	CBC-051 HC	790 x 700 x 850	220-240V	5	5	40	24	R290	0,71 (2)	0,55	50 Hz	19102977	-
									0,71 (2)	0,55	60 Hz	19111025	-
	CBC-081 HC	790 x 800 x 1.290	220-240V	8	8	60	40	R290	1,18 (2)	0,713	50 Hz	19105381	-
									1,18 (2)	0,713	60 Hz	19111026	-
Ø STOCK	CBC-101 HC	790 x 800 x 1.420	220-240V	10	10	100	65	R290	1,62 (2)	1,426	50 Hz	19104477	-
									1,62 (2)	1,426	60 Hz	19111027	-

(2) Evap. -25°C/ Cond. 45°C

Options

			CBC-031 HC (€)	CBC-051 HC (€)	CBC-081 HC (€)	CBC-101 HC (€)
G type plug	CI		0	0	0	0
Opposite opening	OP		-	0	0	0
Castors	C		-	0	0	0
Heated probe	Heat-P		-	0	0	0

Cook & Chill blast chillers



ABCO-102

ABCO-101 HC

ABCO-061 HC

ABCO-06 2/3 HC



General characteristics

- Range of blast chillers designed to be in line with the cooking capacities of iKore ovens to perfectly balance the work loads. 6 trays blast chillers are available to order them stack with the ovens.
- Intuitive 5" Screen touch electronic control placed in the door for more ergonomic use.
- Manual chilling process by time or probe control, both of them adjustable in each cycle as well as the evaporator fan ventilation adjustment in 5 different levels.
- 2 manual chilling modes:
 - Hard cycle: Default freezing cycle. Executes the cycle and maintains a constant temperature of -20°C.
 - Soft cycle: Default refrigeration cycle. Executes an initial cycle and maintains a constant temperature of 0°C.
- 96 preset chilling programmes by Fagor, divided in 8 food categories.
- Possibility to create a personalized cook book with up to 40 self made recipes.
- Additional cycles (pre-cooling, continuous cycle, manual defrost, fish sanitization, ice cream hardening, drying).
- Storing capacity for GN1/1 and EN 60x40 trays (Except 3 trays version) with 65 mm distance among them.



MODEL	DIMENSIONS (MM)	ELECTRIC CONNECTION	CAPACIDAD			PRODUCTION		GAS	COOLING POWER (KW)	ELECTRIC POWER (KW)	FREQUENCY	REFERENCE	€
			GN1/1	EN60X40	GN2/1	COOLING	FREEZING						
ABCO-06 2/3 HC	656 x 633 x 630	220-240V	6 x GN2/3	-	-	12	6	R290	0,565 (2)	0,41	50 Hz	19087540	-
									0,565 (2)	0,41	60 Hz	19097559	-
ABCO-061 HC	900 x 935 x 1.105	220-240V	6	6	-	50	30	R290	0,71 (2)	0,713	50 Hz	19105609	-
									0,71 (2)	0,713	60 Hz	19111029	-
ABCO-101 HC	900 x 935 x 1.766	220-240V	10	6	-	105	0	R290	1,62 (2)	1,426	50 Hz	19105605	-
									1,62 (2)	1,426	60 Hz	19111030	-
ABCO-102	1.200 x 1.130 x 1.766	380-415V	-	10	10	105	70	R452a	4,079 (2)	2,947	50 Hz	19091443	-
									4,079 (2)	2,947	60 Hz	19091444	-

(2) Evap. -25°C/ Cond. 45°C

Options

			ABCO-0623 (€)	ABCO-061 HC (€)	ABCO-101 HC (€)	ABCO-102 (€)
G type plug	CI		0	0	0	-
Heated probe	Heat-P		•	•	•	•
USB	USB		0	0	0	0



20 GN 1/1 Roll-in Blast Chillers



RBP-201



General characteristics

- Cold room structure made by CFC-free, high quality (40 kg/m³) polyurethane insulation panels. 70mm thickness for refrigeration models and 100 mm thickness in mixed cooling version.
- Intuitive 7" Screen touch electronic control placed in the door for more ergonomic use.
- Manual chilling process by time or probe control, both of them adjustable in each cycle.
- 2 manual chilling modes:
 - Hard cycle: Default freezing cycle. Executes the cycle and maintains a constant temperature of -20°C.
 - Soft cycle: Default refrigeration cycle. Executes an initial cycle and maintains a constant temperature of 0°C.
- Possibility to create a personalized cook book with up to 40 self made recipes.
- 2 Additional versions of cold rooms:
 - Pass-Through: Cold room could be feed from the front and back (C).
 - High Powered version with higher evaporator capacity to blast chill or freeze higher amount of product (H).
- Tropicalised cooling unit. Suitable to work at a room temperature up to 43 °C and 65 % humidity.
- Cooling chamber and unit condenser delivered separately.

Cooling chambers

MODEL	DIMENSIONS (MM)	ELECTRIC CONNECTION	TEMPERATURE	PRODUCTION		ELECTRIC POWER (KW)	UNIT CONDENSER	FREQUENCY	REFERENCE	€
				COOLING	FREEZING					
RBP-201	1.480 x 1205 x 2.120	220-240V	+3°C	70	-	0,85	UCS-424	50/60 Hz	19089779	-
RBP-201H	1.480 x 1.205 x 2.120	220-240V	+3°C	105	-	0,85	UCS-528	50/60 Hz	19089780	-
RBP-201C	1.480 x 1.205 x 2.120	220-240V	+3°C	70	-	0,85	UCS-424	50/60 Hz	19089784	-
RBP-201HC	1.480 x 1.205 x 2.120	220-240V	+3°C	105	-	0,85	UCS-528	50/60 Hz	19089785	-
RBM-201	1.530 x 1.255 x 2.220	220-240V	+3°C / -18°C	70	48	0,85	UCC-424	50/60 Hz	19089788	-
RBM-201H	1.530 x 1.255 x 2.220	220-240V	+3°C / -18°C	105	70	0,85	UCC-528	50/60 Hz	19089789	-
RBM-201 C	1.530 x 1.255 x 2.220	220-240V	+3°C / -18°C	70	48	0,85	UCC-424	50/60 Hz	19089792	-
RBM-201HC	1.530 x 1.255 x 2.220	220-240V	+3°C / -18°C	105	70	0,85	UCC-528	50/60 Hz	19089793	-

Unit condensers

MODEL	DIMENSIONS (MM)	ELECTRIC CONNECTION	GAS	COOLING POWER (KW)		ELECTRIC POWER (KW)	FREQUENCY	REFERENCE	€
				(2)	(2)				
UCS-424	1.100 x 805 x 650	380-415V	R452a	5,97	4,25	4,25	50 Hz	19017466	-
				(2)	(2)				
UCS-528	1.100 x 805 x 650	380-415V	R452a	6,95	4,98	4,98	50 Hz	19017467	-
				(2)	(2)				
UCC-424	1.045 x 765 x 637	380-415V	R452a	5,97	4,25	4,25	50 Hz	19015799	-
				(2)	(2)				
UCC-528	1.045 x 765 x 637	380-415V	R452a	6,95	4,98	4,98	50 Hz	19015800	-
				(2)	(2)				

(2) Evap. -25°C/ Cond. 45°C

Accessories

MODEL	CODE	DESCRIPTION	WIDTH	€
RC-700	19015797	Access ramp for RBM-201 Roll-in Blast Chillers	700	-

20 GN 2/1 Roll-in Blast Chillers



RBP-202



General characteristics

- Cold room structure made by CFC-free, high quality (40 kg/ m³) polyurethane insulation panels. 70mm thickness for refrigeration models and 100 mm thickness in mixed cooling version.
- Intuitive 7" Screen touch electronic control placed in the door for more ergonomic use.
- Manual chilling process by time or probe control, both of them adjustable in each cycle.
- 2 manual chilling modes:
 - Hard cycle: Default freezing cycle. Executes the cycle and maintains a constant temperature of -20°C.
 - Soft cycle: Default refrigeration cycle. Executes an initial cycle and maintains a constant temperature of 0°C.
- Possibility to create a personalized cook book with up to 40 self made recipes.
- 2 Additional versions of cold rooms:
 - Pass-Through: Cold room could be feed from the front and back (C).
 - High Powered version with higher evaporator capacity to blast chill or freeze higher amount of product (H).
- Tropicalised cooling unit. Suitable to work at a room temperature up to 43 °C and 65 % humidity.
- Cooling chamber and unit condenser delivered separately.

Cooling chambers

MODEL	DIMENSIONS (MM)	ELECTRIC CONNECTION	TEMPERATURE	PRODUCTION		ELECTRIC POWER (KW)	UNIT CONDENSER	FREQUENCY	REFERENCE	€
				COOLING	FREEZING					
RBP-202	1.670 x 1.395 x 2.120	220-240V	+3°C	150	-	0,85	UCS-842	50/60 Hz	19089782	-
RBP-202H	1.670 x 1.395 x 2.120	220-240V	+3°C	210	-	1,05	UCS-1052	50/60 Hz	19089783	-
RBP-202C	1.670 x 1.395 x 2.120	220-240V	+3°C	150	-	0,85	UCS-842	50/60 Hz	19089786	-
RBP-202HC	1.670 x 1.395 x 2.120	220-240V	+3°C	210	-	1,05	UCS-1052	50/60 Hz	19089787	-
RBM-202	1.720 x 1.445 x 2.220	220-240V	+3°C / -18°C	150	100	0,85	UCC-842	50/60 Hz	19089790	-
RBM-202H	1.720 x 1.445 x 2.220	220-240V	+3°C / -18°C	210	135	1,05	UCC-1052	50/60 Hz	19089791	-
RBM-202 C	1.720 x 1.445 x 2.220	220-240V	+3°C / -18°C	150	100	0,85	UCC-842	50/60 Hz	19089794	-
RBM-202HC	1.720 x 1.445 x 2.220	220-240V	+3°C / -18°C	210	135	1,05	UCC-1052	50/60 Hz	19089795	-

Unit condensers

MODEL	DIMENSIONS (MM)	ELECTRIC CONNECTION	GAS	COOLING POWER (KW)	ELECTRIC POWER (KW)	FREQUENCY	REFERENCE	€
UCS-842	1.450 x 850 x 785	380-415V	R452a	10,53 (2)	6,5	50 Hz	19017468	-
				10,53 (2)	6,5	60 Hz	19108454	-
UCS-1052	1.451 x 850 x 785	380-415V	R452a	13,58 (2)	8,45	50 Hz	19017469	-
				13,58 (2)	8,45	60 Hz	19108457	-
UCC-842	1.452 x 850 x 785	380-415V	R452a	10,53 (2)	6,5	50 Hz	19015801	-
				10,53 (2)	6,5	60 Hz	19040259	-
UCC-1052	1.453 x 850 x 785	380-415V	R452a	13,58 (2)	8,45	50 Hz	19015802	-
				13,58 (2)	8,45	60 Hz	19043036	-

(2) Evap. -25°C/ Cond. 45°C

Accessories

MODEL	CODE	DESCRIPTION	WIDTH	€
RC-800	19015798	Access ramp for RBM-202 Roll-in Blast Chillers	800	-



Bar line

—Back bar counters	347
—Back bar coolers	349
—Top load coolers	352
—Professional uprights	353
—Showcases	357

Special units or any variations from the standard model must be assembled at the factory at an additional charge over the standard model's price.

Please, contact Fagor Professional for any other variation or option that is not included on this list.

Back bar counters



CBCP-3S

CBCP-3S GD



General characteristics

- Interior constructed with AISI-304 stainless steel, exterior in food grade stainless steel.
- Heavy-duty stainless-steel working top with 100 mm high splash-back, preventing spillage behind the counter.
- Removable and height adjustable epoxy coated grids with a maximum loading capacity of up to 40 kg.
- Double-glazed doors insulated with low thermal emissivity to reduce heat transfer with ergonomic handle (models with glass doors).

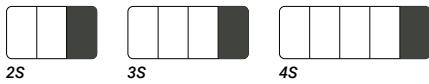

	MODEL	DIMENSIONS (MM)	VOLUME (L)	TEMPERATURE (°C)	DEFROST	GAS	COOLING POWER (KW)	ELECTRIC POWER (KW)	ANNUAL CONSUMPTION (KWH)	ENERGY EFFICIENCY CLASS	FREQUENCY	REFERENCE	€
Ø STOCK	CBCP-2S	1.492 x 600 x 1.045	355	0 +8 °C	Stop	R-600a	0,361 (1)	0,203	C	1.095 (4)	50 Hz	19089695	-
						R290	0,398 (1)	0,295	-	-	60 Hz	19090397	-
Ø STOCK	CBCP-3S	2.017 x 600 x 1.045	551	0 +8 °C	Stop	R-600a	0,361 (1)	0,203	C	1.259 (4)	50 Hz	19089697	-
						R290	0,398 (1)	0,295	-	-	60 Hz	19090398	-
	CBCP-4S	2.542 x 600 x 1.045	747	0 +8 °C	Stop	R-600a	0,436 (1)	0,224	C	1.427 (4)	50 Hz	19089698	-
						R-600a	0,437 (1)	0,241	-	-	60 Hz	19090399	-
	CBCP-2S GD	1.492 x 600 x 1.045	355	0 +8 °C	Stop	R-600a	0,361 (1)	0,207	C	1.378 (5)	50 Hz	19089699	-
						R290	0,398 (1)	0,299	-	-	60 Hz	19090400	-
	CBCP-3S GD	2.017 x 600 x 1.045	551	0 +8 °C	Stop	R-600a	0,361 (1)	0,209	C	1.630 (5)	50 Hz	19089700	-
						R290	0,398 (1)	0,301	-	-	60 Hz	19090401	-
	CBCP-4S GD	2.542 x 600 x 1.045	747	0 +8 °C	Stop	R-600a	0,436 (1)	0,232	C	1.932 (5)	50 Hz	19089701	-
						R-600a	0,437 (1)	0,249	-	-	60 Hz	19090402	-

(1) Evap. -10°C/ Cond. 45°C (5) According to EN23953 standard

Options

			CBCP-2S (€)	CBCP-3S (€)	CBCP-4S (€)	CBCP-2S GD (€)	CBCP-3S GD (€)	CBCP-4S GD (€)
Panoramic opening	PO		0	0	0	0	0	0
Left group	LG		0	0	0	0	0	0
No top	NT		0	0	0	0	0	0
No splash-back	NS		0	0	0	0	0	0
1/2 + 1/2 Drawer	H		0	0	0	-	-	-
G type plug	CI		0	0	0	0	0	0
Lock	LC		0	0	0	●	●	●
Castors	C		0	0	0	0	0	0
Back in Stainless Steel	BS		0	0	0	0	0	0
Frame heater	FH		0	0	0	0	0	0
Tilting Drawer	TV		0	0	0	0	0	0
Glass door	GD		-	-	-	●	●	●

Standard Accessories

CODE	DESCRIPTION	2S	3S	4S	€	
19097777	Epoxy grid Snack 405x460	pc	2	2	2	-
19097775	Epoxy grid Snack 405x525	pc	-	1	2	-

Other Accessories

CODE	DESCRIPTION	€
19004924	Kit drawers 1/2+2/3 GN	-

Back bar remote counters



CBCP-3S/R

CBCP-3S/R GD



General characteristics

- Interior constructed with AISI-304 stainless steel exterior in food grade stainless steel.
- Heavy-duty stainless-steel working top with 100 mm high splash-back, preventing spillage behind the counter.
- Equipment without unit condenser, ready for remote cooling unit connection.
- Removable and height adjustable epoxy coated grids with a maximum loading capacity of up to 40 kg.
- Double-glazed doors insulated with low thermal emissivity to reduce heat transfer with ergonomic handle (models with glass doors).

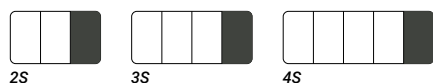

MODEL	DIMENSIONS (MM)	VOLUME (L)	TEMPERATURE (°C)	DEFROST	COOLING POWER (KW)	ELECTRIC POWER (KW)	FREQUENCY	REFERENCE	€
CBCP-2S/R	1.192 x 600 x 1.045	355	0 +8 °C	Stop	0,361 (1)	0,029	50/60 Hz	19089702	-
CBCP-3S/R	1.717 x 600 x 1.045	551	0 +8 °C	Stop	0,361 (1)	0,029	50/60 Hz	19089703	-
CBCP-4S/R	2.242 x 600 x 1.045	747	0 +8 °C	Stop	0,436 (1)	0,029	50/60 Hz	19089704	-
CBCP-2S/R GD	1.192 x 600 x 1.045	355	0 +8 °C	Stop	0,361 (1)	0,034	50/60 Hz	19089705	-
CBCP-3S/R GD	1.717 x 600 x 1.045	551	0 +8 °C	Stop	0,361 (1)	0,036	50/60 Hz	19089706	-
CBCP-4S/R GD	2.242 x 600 x 1.045	747	0 +8 °C	Stop	0,436 (1)	0,038	50/60 Hz	19089707	-

(1) Evap. -10°C/ Cond. 45°C

Options

			CBCP-2S/R (€)	CBCP-3S/R (€)	CBCP-4S/R (€)	CBCP-2S/R GD (€)	CBCP-3S/R GD (€)	CBCP-4S/R GD (€)
Panoramic opening	PO		0	0	0	0	0	0
No top	NT		0	0	0	0	0	0
No splash-back	NS		0	0	0	0	0	0
1/2 + 1/2 Drawer	H		0	0	0	-	-	-
G type plug	CI		0	0	0	0	0	0
Lock	LC		0	0	0	●	●	●
Back in Stainless Steel	BS		0	0	0	0	0	0
Frame heater	FH		0	0	0	0	0	0
Tilting Drawer	TV		0	0	0	0	0	0
Glass door	GD		-	-	-	●	●	●

Standard Accessories

CODE	DESCRIPTION	2S	3S	4S	€	
19097777	Epoxy grid Snack 405x460	pc	2	2	-	
19097775	Epoxy grid Snack 405x525	pc	-	1	2	-

Other Accessories

CODE	DESCRIPTION	€
19004924	Kit drawers 1/2+2/3 GN	-

BACK BAR COOLERS

BBC Series



RBBC-3

RBBC-2

CC4



220-240V



General characteristics

- Interior constructed in grey plastic coated steel, exterior constructed in black plastic coated steel.
- Heavy-duty stainless-steel working top with 30 mm CFC-free, high-density (40 kg/m³) polyurethane insulation.
- Integrated door handle that avoids dust and dirt collection.
- Removable and height adjustable grey coated steel grids with a maximum loading capacity of up to 40 kg.

MODEL	DIMENSIONS (MM)	VOLUME (L)	TEMPERATURE (°C)	DEFROST	GAS	COOLING POWER (KW)	ELECTRIC POWER (KW)	ANNUAL CONSUMPTION (KWH)	ENERGY EFFICIENCY CLASS	FREQUENCY	REFERENCE	€
RBBC-2	1.435 x 512 x 850	264	0 +8 °C	Stop	R-600a	0,293 (1)	0,175	B	216 (5)	50 Hz	19106108	-
					R-600a	0,293 (1)	0,175	-	-	60 Hz	19109437	-
RBBC-3	1.989 x 512 x 850	413	0 +8 °C	Stop	R-600a	0,293 (1)	0,175	B	304 (5)	50 Hz	19106109	-
					R-600a	0,293 (1)	0,175	-	-	60 Hz	19109438	-

(1) Evap. -10°C/ Cond. 45°C (5) According to EN23953 standard

Options

			RBBC-2 (€)	RBBC-3 (€)
Panoramic opening	PO		●	●
G type plug	CI		○	○
Lock	LC		●	●

Standard Accessories

	CODE	DESCRIPTION		2	3	€
	19106465	Grey coated steel grid 477x342	pc	4	4	-
	19106466	Grey coated steel grid 549x342	pc	-	2	-
	19106517	Steel grid support	pc	4	6	-

BACK BAR COOLERS

BBC Series Display



CC4

50 mm

220-240V

TYPE F

General characteristics

- Interior constructed in grey coated steel, exterior constructed in black coated steel.
- Heavy-duty stainless-steel working top with 20 mm CFC-free, high-density (40 kg/m³) polyurethane insulation.
- Double-glazed doors insulated with low thermal emissivity to reduce heat transfer with ergonomic handle.
- Removable and height adjustable grey coated steel grids with a maximum loading capacity of up to 40 kg.

MODEL	DIMENSIONS (MM)	VOLUME (L)	TEMPERATURE (°C)	DEFROST	GAS	COOLING POWER (KW)	ELECTRIC POWER (KW)	ANNUAL CONSUMPTION (KWH)	ENERGY EFFICIENCY CLASS	FREQUENCY	REFERENCE	€
RBBC-2 GD	1.435 x 512 x 850	264	0 +8 °C	Stop	R-600a	0,293 (1)	0,175	C	388 (5)	50 Hz	19106034	-
					R-600a	0,293 (1)	0,175	-	-	60 Hz	19109435	-
RBBC-3 GD	1.989 x 512 x 850	413	0 +8 °C	Stop	R-600a	0,293 (1)	0,175	C	523 (5)	50 Hz	19106035	-
					R-600a	0,293 (1)	0,175	-	-	60 Hz	19109436	-

(1) Evap. -10°C/ Cond. 45°C (5) According to EN23953 standard

Options

			RBBC-2 GD (€)	RBBC-3 GD (€)
Panoramic opening	PO		●	●
G type plug	CI		○	○
Lock	LC		●	●
Glass door	GD		●	●

Standard Accessories

	CODE	DESCRIPTION		2	3	€
	19106465	Grey coated steel grid 477x342	pc	4	4	-
	19106466	Grey coated steel grid 549x342	pc	-	2	-
	19106517	Steel grid support	pc	4	6	-

BACK BAR COOLERS

ERM Series



CC4

220-240V



TYPE F

General characteristics

- Interior constructed in grey coated steel, exterior constructed in black coated steel.
- Interior and exterior built-in with food grade stainless steel for intensive professional applications (SS models).
- Double-glazed doors insulated with low thermal emissivity to reduce heat transfer with ergonomic handle.
- Equipped with removable and height adjustable 2 epoxy coated grids with a maximum loading capacity of up to 40 kg.

ERM-2

ERM-2 SS



ERM-1



ERM-2



ERM-3

MODEL	DIMENSIONS (MM)	VOLUME (L)	TEMPERATURE (°C)	DEFROST	GAS	COOLING POWER (KW)	ELECTRIC POWER (KW)	ANNUAL CONSUMPTION (KWH)	ENERGY EFFICIENCY CLASS	FREQUENCY	REFERENCE	€
900 mm Height												
Black coated												
EERM-1	625 x 565 x 900	182	0 +8 °C	Stop	R290	0,49 (1)	0,22	G	1.063 (5)	50/60 Hz	19089713	-
EERM-2	925 x 565 x 900	260	0 +8 °C	Stop	R290	0,369 (1)	0,28	G	1.175 (5)	50/60 Hz	19089714	-
EERM-3	1.375 x 565 x 900	408	0 +8 °C	Stop	R290	0,369 (1)	0,285	F	1.186 (5)	50/60 Hz	19089715	-
Stainless steel												
EERM-1 SS	625 x 565 x 900	182	0 +8 °C	Stop	R290	0,49 (1)	0,22	G	1.063 (5)	50/60 Hz	19089710	-
EERM-2 SS	925 x 565 x 900	260	0 +8 °C	Stop	R290	0,369 (1)	0,28	G	1.281 (5)	50/60 Hz	19089711	-
EERM-3 SS	1.375 x 565 x 900	408	0 +8 °C	Stop	R290	0,369 (1)	0,285	G	1.475 (5)	50/60 Hz	19089712	-
800 mm Height												
Black coated												
EERMU-1	625 x 565 x 800	140	0 +8 °C	Stop	R290	0,49 (1)	0,22	G	1.063 (5)	50/60 Hz	19089719	-
EERMU-2	925 x 565 x 800	202	0 +8 °C	Stop	R290	0,369 (1)	0,28	G	1.281 (5)	50/60 Hz	19089720	-
EERMU-3	1.375 x 565 x 800	318	0 +8 °C	Stop	R290	0,369 (1)	0,285	G	1.475 (5)	50/60 Hz	19089721	-
Stainless steel												
EERMU-1 SS	625 x 565 x 800	140	0 +8 °C	Stop	R290	0,49 (1)	0,22	G	1.063 (5)	50/60 Hz	19089716	-
EERMU-2 SS	925 x 565 x 800	202	0 +8 °C	Stop	R290	0,369 (1)	0,28	G	1.281 (5)	50/60 Hz	19089717	-
EERMU-3 SS	1.375 x 565 x 800	318	0 +8 °C	Stop	R290	0,369 (1)	0,285	G	1.475 (5)	50/60 Hz	19089718	-

(1) Evap. -10°C/ Cond. 45°C (5) According to EN23953 standard

Options

			EERM-1 (€)	EERM-2 (€)	EERM-3 (€)	EERMU-1 (€)	EERMU-2 (€)	EERMU-3 (€)
Panoramic opening	PO		-	●	●	-	●	●
G type plug	CI		0	0	0	0	0	0
Lock	LC		●	●	●	●	●	●
Glass door	GD		●	●	●	●	●	●

Standard Accessories

CODE	DESCRIPTION		1	2	3	€
19106469	Epoxy grid for ERM-1	pc	2	-	-	-
19106510	Epoxy grid for ERM-2	pc	-	2	-	-
19106511	Epoxy grid for ERM-3	pc	-	-	2	-
19106517	Steel grid support	pc	2	3	4	-

BACK BAR COOLERS

Top Load Bottle Coolers



General characteristics

CC4

220-240V



TYPE F

- Interior and exterior built-in with food grade stainless steel for intensive professional applications.
- Static cooling system generated by copper piping and aluminum flaps evaporator.
- Top mounted, fully integrated handle stainless-steel sliding door.

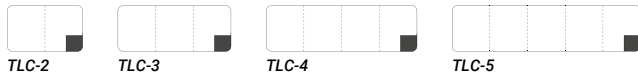

MODEL	DIMENSIONS (MM)	VOLUME (L)	TEMPERATURE (°C)	GAS	COOLING POWER (KW)	ELECTRIC POWER (KW)	FREQUENCY	REFERENCE	€
TLC-2 SS	1.014 x 560 x 850	223	-1 +6 °C	R-600a	0,105 (1)	0,109	50 Hz	19089722	-
				R-600a	0,248 (1)	0,155	60 Hz	19090419	-
TLC-3 SS	1.504 x 560 x 850	381	-1 +6 °C	R-600a	0,292 (1)	0,207	50 Hz	19089723	-
				R-600a	0,309 (1)	0,163	60 Hz	19090420	-
TLC-4 SS	1.994 x 560 x 850	539	-1 +6 °C	R-600a	0,292 (1)	0,207	50 Hz	19089724	-
				R-600a	0,359 (1)	0,213	60 Hz	19097806	-
TLC-5 SS	2.482 x 560 x 850	696	-1 +6 °C	R-600a	0,292 (1)	0,207	50 Hz	19089725	-
				R-600a	0,359 (1)	0,213	60 Hz	19090282	-

(1) Evap. -10°C/ Cond. 45°C

Options

			TLC-2 SS (€)	TLC-3 SS (€)	TLC-4 SS (€)	TLC-5 SS (€)
G type plug	Cl		0	0	0	0

PROFESSIONAL REFRIGERATION UPRIGHT

Refrigeration Upright



UP-651 SS

UP-451

UP-251 SS

CC4

220-240V



TYPE F

General characteristics

- Interior constructed with thermoformed food grade ABS.
- Internally designed forced draft cooling system with the evaporator integrated in the back side of the upright guarantees optimal cold distribution, efficiency and performance.
- Optimal air circulation system that guarantees a balanced and constant distribution throughout the equipment, so that the temperature remains uniform. It helps preserve food for longer.
- 400 and 600 model equipped with 4 removable and height adjustable epoxy coated grids.
- 200 model equipped with 2 removable and height adjustable epoxy coated grids.

MODEL	DIMENSIONS (MM)	VOLUME (L)	TEMPERATURE (°C)	DEFROST	GAS	COOLING POWER (KW)	ELECTRIC POWER (KW)	ANNUAL CONSUMPTION (KWH)	ENERGY EFFICIENCY CLASS	FREQUENCY	REFERENCE	€
White epoxy exterior												
UP-251	626 x 600 x 850	125	0 +8 °C	Stop	R-600a	0,14 (1)	0,091	A	488 (4)	50 Hz	19089735	-
						0,248 (1)	0,117	-	-	60 Hz	19076162	-
UP-451	626 x 740 x 1.865	459	0 +8 °C	Stop	R-600a	0,292 (1)	0,186	D	866 (4)	50 Hz	19089736	-
						0,437 (1)	0,191	-	-	60 Hz	19076159	-
UP-651	780 x 740 x 1.865	600	0 +8 °C	Stop	R-600a	0,292 (1)	0,186	D	954 (4)	50 Hz	19089737	-
						0,437 (1)	0,221	-	-	60 Hz	19076161	-
Stainless steel exterior												
UP-251 SS	626 x 600 x 850	125	0 +8 °C	Stop	R-600a	0,14 (1)	0,091	A	488 (4)	50 Hz	19089729	-
						0,248 (1)	0,117	-	-	60 Hz	19091186	-
UP-451 SS	626 x 740 x 1.865	459	0 +8 °C	Stop	R-600a	0,292 (1)	0,186	D	866 (4)	50 Hz	19089730	-
						0,437 (1)	0,191	-	-	60 Hz	19091169	-
UP-651 SS	780 x 740 x 1.865	600	0 +8 °C	Stop	R-600a	0,292 (1)	0,186	D	954 (4)	50 Hz	19089731	-
						0,437 (1)	0,221	-	-	60 Hz	19096458	-

(1) Evap. -10°C/ Cond. 45°C (4) According to EN22041 standard

Options

			UP-251 (€)	UP-451 (€)	UP-651 (€)
G type plug	Cl		o	o	o
Castors	C		o	o	o

Standard Accessories

	CODE	DESCRIPTION		UP-251	UP-451	UP-651	€
	19106512	Epoxy grid 493x392	pc	2	-	-	-
	19106517	Steel grid support	pc	2	-	-	-
	19106513	Epoxy grid 497x510	pc	-	3	-	-
	19106514	Epoxy grid 497x380	pc	-	1	-	-
	19106515	Epoxy grid 651x510	pc	-	-	3	-
	19106516	Epoxy grid 651x380	pc	-	-	1	-

PROFESSIONAL REFRIGERATION UPRIGHT

Refrigerated Display Uprights



UP-651 GD UP-451 GD UP-251 GD

CC4

220-240V



TYPE F

General characteristics

- Interior constructed with thermoformed food grade ABS.
- Double-glazed doors insulated with low thermal emissivity to reduce heat transfer with ergonomic handle.
- Internally designed forced draft cooling system with the evaporator integrated in the back side of the upright guarantees optimal cold distribution, efficiency and performance.
- 400 and 600 model equipped with 4 removable and height adjustable epoxy coated grids.
- 200 model equipped with 2 removable and height adjustable epoxy coated grids.

MODEL	DIMENSIONS (MM)	VOLUME (L)	TEMPERATURE (°C)	DEFROST	GAS	COOLING POWER (KW)	ELECTRIC POWER (KW)	ANNUAL CONSUMPTION (KWH)	ENERGY EFFICIENCY CLASS	FREQUENCY	REFERENCE	€
White epoxy exterior												
⊗ STOCK	UP-251 GD	626 x 600 x 850	125	+2 +8 °C	Stop	R-600a	0,14 (1) 0,248 (1)	0,091 0,117	B -	613 (5) 60 Hz	19089741 19096457	- -
	UP-451 GD	626 x 740 x 1.865	459	+2 +8 °C	Stop	R-600a	0,292 (1) 0,437 (1)	0,193 0,191	B -	1.024 (5) 60 Hz	19089742 19091181	- -
	UP-651 GD	780 x 740 x 1.865	600	+2 +8 °C	Stop	R-600a	0,292 (1) 0,437 (1)	0,193 0,221	B -	1.095 (5) 60 Hz	19089743 19110955	- -
Stainless steel exterior												
	UP-251 SS GD	626 x 600 x 850	125	+2 +8 °C	Stop	R-600a	0,14 (1) 0,248 (1)	0,091 0,117	B -	613 (5) 60 Hz	19100114 19110964	- -
	UP-451 SS GD	626 x 740 x 1.865	459	+2 +8 °C	Stop	R-600a	0,292 (1) 0,437 (1)	0,193 0,191	B -	1.024 (5) 60 Hz	19100115 19110965	- -
	UP-651 SS GD	780 x 740 x 1.865	600	+2 +8 °C	Stop	R-600a	0,292 (1) 0,437 (1)	0,193 0,221	B -	1.095 (5) 60 Hz	19100116 19091184	- -

(1) Evap. -10°C/ Cond. 45°C (5) According to EN23953 standard

Options

			UP-251 GD (€)	UP-451 GD (€)	UP-651 GD (€)
G type plug	CI		o	o	o
Castors	C		o	o	o
Glass door	GD		●	●	●

Standard Accessories

	CODE	DESCRIPTION		UP-251 GD	UP-451 GD	UP-651 GD	€
	19106512	Epoxy grid 493x392	pc	2	-	-	-
	19106517	Steel grid support	pc	2	-	-	-
	19106513	Epoxy grid 497x510	pc	-	3	-	-
	19106514	Epoxy grid 497x380	pc	-	1	-	-
	19106515	Epoxy grid 651x510	pc	-	-	3	-
	19106516	Epoxy grid 651x380	pc	-	-	1	-

PROFESSIONAL REFRIGERATION UPRIGHT

Freezing Uprights



UN-651 SS

UN-451

UN-251 SS

CC4

220-240V



TYPE F

General characteristics

- Interior constructed with white coated galvanized steel.
- Internally designed static cooling system. Interior shelves built-in epoxy coated copper pipes, acts as an evaporator to cool down the products.
- Ice defrosting process needs to be done manually.
- 400 and 600 models with 7 levels of grills and 235mm distance among them.
- 200 models with 3 levels and 200mm distance among them.

MODEL	DIMENSIONS (MM)	VOLUME (L)	TEMPERATURE (°C)	GAS	COOLING POWER (KW)	ELECTRIC POWER (KW)	FREQUENCY	REFERENCE	€
White epoxy exterior									
UN-251	626 x 600 x 850	125	-22 -15 °C	R290	0,218 (2)	0,142	50 Hz	19089738	-
				R290	0,158 (2)	0,156	60 Hz	19076165	-
UN-451	626 x 740 x 1.865	459	-22 -15 °C	R290	0,228 (2)	0,143	50 Hz	19089739	-
				R290	0,197 (2)	0,195	60 Hz	19076163	-
◎ STOCK UN-651	780 x 740 x 1.865	600	-22 -15 °C	R290	0,199 (2)	0,145	50 Hz	19089740	-
				R290	0,197 (2)	0,221	60 Hz	19076164	-
Stainless steel exterior									
◎ STOCK UN-251 SS	626 x 600 x 850	125	-22 -15 °C	R290	0,218 (2)	0,142	50 Hz	19089732	-
				R290	0,158 (2)	0,156	60 Hz	19096456	-
UN-451 SS	626 x 740 x 1.865	459	-22 -15 °C	R290	0,228 (2)	0,143	50 Hz	19089733	-
				R290	0,197 (2)	0,195	60 Hz	19096454	-
UN-651 SS	780 x 740 x 1.865	600	-22 -15 °C	R290	0,199 (2)	0,145	50 Hz	19089734	-
				R290	0,197 (2)	0,221	60 Hz	19096455	-

(2) Evap. -25°C/ Cond. 45°C

Options

			UN-251 (€)	UN-451 (€)	UN-651 (€)
G type plug	Cl		o	o	o
Castors	C		o	o	o

PROFESSIONAL REFRIGERATION UPRIGHT

Freezing Display Uprights



UN-651 GD UN-451 GD UN-251 GD

General characteristics

CC4

220-240V

TYPE F

- Interior constructed with thermoformed food grade ABS.
- Double-glazed doors insulated with low thermal emissivity to reduce heat transfer with ergonomic handle.
- Internally designed forced draft cooling system with the evaporator integrated in the back side of the upright guarantees optimal cold distribution, efficiency and performance.
- 400 and 600 model equipped with 7 removable and height adjustable epoxy coated grids.
- 200 model equipped with 3 removable and height adjustable epoxy coated grids.

MODEL	DIMENSIONS (MM)	VOLUME (L)	TEMPERATURE (°C)	GAS	ELECTRIC POWER (KW)	ENERGY EFFICIENCY CLASS	ANNUAL CONSUMPTION (KWH)	FREQUENCY	REFERENCE	€	
White epoxy exterior											
⊙ STOCK	UN-251 GD	600 x 585 x 855	78	-10 -25°C	R290	0,27	D	2.001 (5)	50 Hz	19111240	-
⊙ STOCK	UN-451 GD	600 x 585 x 1855	258	-10 -25°C	R290	0,38	C	1.930 (5)	50 Hz	19111241	-
⊙ STOCK	UN-651 GD	777 x 695 x 1895	469	-10 -25°C	R290	0,48	C	3.671 (5)	50 Hz	19111242	-

(5) According to EN23953 standard

Options

	UN-251 GD (€)	UN-451 GD (€)	UN-651 GD (€)
Glass door GD	●	●	●

SHOWCASES

Snack



ST-139P



ST-175C

CC4

220-240V



TYPE F

General characteristics

- Interior built-in with food grade stainless steel for intensive professional applications.
- Exterior constructed with anodized aluminum profile, tempered glass on top and back and black coated PVC in the laterals.
- Internal compartment sized to fit 40 mm depth GN1/3 containers (not included).
- Static cooling system. Cold is generated through a copper coil located on the bottom plate of the vitrine (except neutral version).

MODEL	DIMENSIONS (MM)	CONTAINERS	QUANTITY	TEMPERATURE (°C)	GAS	COOLING POWER (KW)	ELECTRIC POWER (KW)	FREQUENCY	REFERENCE	€
Flat glass cover showcase										
ST-139P	1.380 x 415 x 270	GN1/3	6	+2 +8 °C	R-600a	0,169 (1)	0,105	50 Hz	19089745	-
					R290	0,299 (1)	0,174	60 Hz	19090413	-
ST-175P	1.732 x 415 x 270	GN1/3	8	+2 +8 °C	R-600a	0,169 (1)	0,106	50 Hz	19089746	-
					R290	0,299 (1)	0,175	60 Hz	19090415	-
Curved glass cover showcase										
ST-139C	1.380 x 415 x 270	GN1/3	6	+2 +8 °C	R-600a	0,169 (1)	0,105	50 Hz	19089747	-
					R290	0,299 (1)	0,174	60 Hz	19090414	-
ST-175C	1.732 x 415 x 270	GN1/3	8	+2 +8 °C	R-600a	0,169 (1)	0,106	50 Hz	19089748	-
					R290	0,299 (1)	0,175	60 Hz	19090416	-
Neutral flat glass cover showcase										
ST-139NP	1.380 x 415 x 270	-	-	-	-	-	-	-	19089749	-
ST-175NP	1.732 x 415 x 270	-	-	-	-	-	-	-	19089750	-
Neutral curved glass cover showcase										
ST-139NC	1.380 x 415 x 270	-	-	-	-	-	-	-	19089751	-
ST-175NC	1.732 x 415 x 270	-	-	-	-	-	-	-	19089752	-

(1) Evap. -10°C/ Cond. 45°C

Options

		ST-139P (€)	ST-175P (€)	ST-139C (€)	ST-175C (€)
G type plug	CI	0	0	-	-

SHOWCASES

Sushi



SS-139C



SS-175C

CC4

220-240V



TYPE F

General characteristics

- Interior and exterior built-in with food grade stainless steel for intensive professional applications with perforated inner tray for food.
- Exterior constructed with anodized aluminum profile, tempered glass on top and back and Black coated PVC in the laterals.
- Double static cooling system. Cold is generated through a copper coil located on the bottom plate of the vitrin and a copper coil with aluminum fins mounted in the curved glass cover.





MODEL	DIMENSIONS (MM)	TEMPERATURE (°C)	GAS	COOLING POWER (KW)	ELECTRIC POWER (KW)	FREQUENCY	REFERENCE	€
Curved glass cover showcase								
SS-139C	1.380 x 415 x 278	-4 +1 °C	R-600a	0,169 (1)	0,105	50 Hz	19089753	-
			R290	0,299 (1)	0,174	60 Hz	19090417	-
SS-175C	1.730 x 415 x 270	-4 °C +1 °C	R-600a	0,169 (1)	0,106	50 Hz	19089754	-
			R290	0,299 (1)	0,175	60 Hz	19090418	-

(1) Evap. -10°C/ Cond. 45°C

Options

		SS-139C (€)	SS-175C (€)
G type plug	CI	0	0

Accessories

MODEL	REFERENCE	DESCRIPTION	WHERE USED	€
Door orientation kit				
 KDO-4-R	19098305	Door orientation kit right	Back bar counters	-
 KDO-4-L	19098304	Door orientation kit left	Back bar counters	-
Drawers kit				
 KC-6 Ø80	19016846	Kit 4 castors Ø80	Back bar counters	-
 KC-6 Ø80	19011005	Kit 6 castors Ø80	Back bar counters	-



Foodservice Refrigeration



Compact and reliable components ideal for any bar professional.

Wine cellars & meat dry agers

— Wine cellars.....	365
— Meat dry agers	370

A wine cellar for each need

How many bottles will fit in ?

We suggest you to use this type of shelf for ... 

Layout example according to the wine cellar height 2300 / 2600



Capacity
bottles/
shelf

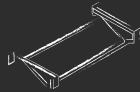

x2 / x2
DIS-20



Capacity
08 bottles/
shelf

Still and/or low alcohol wines

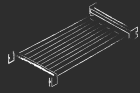

x1 / x2
DIS-0-180



Capacity
08 bottles/
shelf

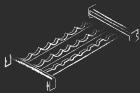

x1 / x2
DIS-0-90



Capacity
43 bottles/
shelf

Champagne, sparkling and high alcohol wines

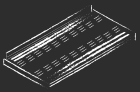

x1 / x1
DIS-90



Capacity
43 bottles/
shelf

Base





Cellar height

2300 / 2600
mm

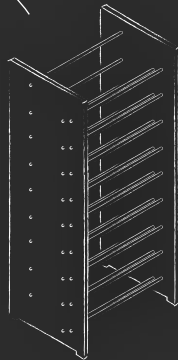

DIM-20-23
DIM-20-26

DIM-20-23

DIM-20-26

Capacity

63 bottles/
block

Capacity

77 bottles/
block

09 shelves/
block

11 shelves/
block



Capacity

07 bottles/
shelf

ADVANCE

Central wine cellars



FWC-2301-T1-C-L-W-GRE TR

FWC-2301-T1-C-L-W-BLA TR

CC5

220-240V



TYPE F



LED

General characteristics

- Wine cellar specially designed to preserve, display and distribute wine.
- Interior and exterior built-in with coated stainless steel for intensive professional applications.
- Double glazed side and central walls with double-layered glass and air chamber filled with argon between them.
- Glasses and door frames heated to avoid condensations.
- Models available in two (2) colors: Black (BLA) and grey (GRE).
- For easy delivery, wine cellars are shipped in two sections: body and removable top section containing complete refrigeration unit.
- Decorative plinth included as a standard element. Shelves and hooks should be requested separately and are supplied disassembled.



MODEL	DIMENSIONS (mm)	TEMPERATURE	DEFROST	GAS	COOLING POWER (kW)	ELECTRIC POWER (kW)	FREQUENCY	REFERENCE	€
H = 2.300 mm Cellars									
FWC-2301-T1-C-L-W-GRE TR	862 x 632 x 2.300	+4 +18 °C	Electric	R290	0,74 (6)	1,335	50 Hz	19092285	-
					0,74 (6)	1,402	60 Hz	19092286	-
FWC-2301-T1-C-L-W-BLA TR	862 x 632 x 2.300	+4 +18 °C	Electric	R290	0,74 (6)	1,335	50 Hz	19092282	-
					0,74 (6)	1,402	60 Hz	19092283	-
H = 2.600 mm Cellars									
FWC-2601-T1-C-L-W-GRE TR	862 x 632 x 2.600	+4°C +18°C	Electric	R290	0,74 (6)	1,42	50 Hz	19092303	-
					0,74 (6)	1,491	60 Hz	19092304	-
FWC-2601-T1-C-L-W-BLA TR	862 x 632 x 2.600	+4°C +18°C	Electric	R290	0,74 (6)	1,42	50 Hz	19092300	-
					0,74 (6)	1,491	60 Hz	19092301	-

(6) Evap. -10°C/ Cond. 55°C

Options

			FWC-2301-T1-C (€)	FWC-2601-T1-C (€)
G type plug	CI		0	0
Lock	LC		0	0
Remote group	RG		0	0

Accessories

	REFERENCE	MODEL	BOTTLES PER SHELF	SHELF CAPACITY		BOTTLE CAPACITY		€
				H = 2.300 MM	H = 2.600 MM	H = 2.300 MM	H = 2.600 MM	
Methacrylate structure with rod shelving								
	19067947	DIM 20-23	7	9	-	63	-	-
	19067948	DIM 20-26	7	-	11	-	77	-
Methacrylate structure with rod shelving								
	19067949	DIS-90	43	3	4	129	172	-
	19067950	DIS 0-90	8	9	11	72	88	-
	19067951	DIS 0-180	8	9	11	72	88	-
	19067952	DIS-20	9	9	11	81	99	-

ADVANCE

Central wine cellars



FWC-2302-T2-C-LR-W-GRE TR

FWC-2302-T1-C-L-W-BLA TR

- CC5
- 220-240V
- TYPE F
- LED

General characteristics

- Wine cellar specially designed to preserve, display and distribute wine.
- Interior and exterior built-in with coated stainless steel for intensive professional applications.
- Double glazed side and central walls with double-layered glass and air chamber filled with argon between them.
- Glasses and door frames heated to avoid condensations.
- Models available in two (2) colors: Black (BLA) and grey (GRE).
- For easy delivery, wine cellars are shipped in two sections: body and removable top section containing complete refrigeration unit.
- Decorative plinth included as a standard element. Shelves and hooks should be requested separately and are supplied disassembled.



MODEL	DIMENSIONS (mm)	TEMPERATURE	DEFROST	GAS	COOLING POWER (kW)	ELECTRIC POWER (kW)	FREQUENCY	REFERENCE	€
H = 2.300 mm Cellars									
FWC-2302-T1-C-LR-W-GRE TR	1.697 x 632 x 2.300	+4°C +18°C	Electric	R290	1,48 (6) 1,48 (6)	2,295 2,41	50 Hz 60 Hz	19092291 19092292	- -
FWC-2302-T1-C-LR-W-BLA TR	1.697 x 632 x 2.300	+4°C +18°C	Electric	R290	1,48 (6) 1,48 (6)	2,295 2,41	50 Hz 60 Hz	19092288 19092289	- -
FWC-2302-T2-C-LR-W-GRE TR	1.697 x 632 x 2.300	+4°C +18°C	Electric	R290	0,74 (6) 0,74 (6)	2,52 2,646	50 Hz 60 Hz	19092297 19092298	- -
FWC-2302-T2-C-LR-W-BLA TR	1.697 x 632 x 2.300	+4°C +18°C	Electric	R290	0,74 (6) 0,74 (6)	2,52 2,646	50 Hz 60 Hz	19092294 19092295	- -
H = 2.600 mm Cellars									
FWC-2602-T1-C-LR-W-GRE TR	1.697 x 632 x 2.600	+4°C +18°C	Electric	R290	1,48 (6) 1,48 (6)	2,7 2,835	50 Hz 60 Hz	19092309 19092310	- -
FWC-2602-T1-C-LR-W-BLA TR	1.697 x 632 x 2.600	+4°C +18°C	Electric	R290	1,48 (6) 1,48 (6)	2,7 2,835	50 Hz 60 Hz	19092306 19092307	- -
FWC-2602-T2-C-LR-W-GRE TR	1.697 x 632 x 2.600	+4°C +18°C	Electric	R290	0,74 (6) 0,74 (6)	2,8 2,94	50 Hz 60 Hz	19092315 19092316	- -
FWC-2602-T2-C-LR-W-BLA TR	1.697 x 632 x 2.600	+4°C +18°C	Electric	R290	0,74 (6) 0,74 (6)	2,8 2,94	50 Hz 60 Hz	19092312 19092313	- -

(6) Evap. -10°C/ Cond. 55°C

Options

			FWC-2302-T1-C (€)	FWC-2602-T1-C (€)
G type plug	CI		0	0
Lock	LC		0	0
Remote group	RG		0	0

Accessories

	REFERENCE	MODEL	BOTTLES PER SHELF	SHELF CAPACITY		BOTTLE CAPACITY		€
				H = 2.300 MM	H = 2.600 MM	H = 2.300 MM	H = 2.600 MM	
Methacrylate structure with rod shelving								
	19067947	DIM 20-23	7	18	-	63	-	-
	19067948	DIM 20-26	7	-	22	-	77	-
Methacrylate structure with rod shelving								
	19067949	DIS-90	43	6	8	258	344	-
	19067950	DIS 0-90	8	18	22	144	176	-
	19067951	DIS 0-180	8	18	22	144	176	-
	19067952	DIS-20	9	18	22	162	198	-

ADVANCE

Wall wine cellars



FWC-2601-T1-W-L-W-GRE TR

FWC-2601-T1-W-L-W-BLA TR

CC5

220-240V



TYPE F



LED

General characteristics

- Wine cellar specially designed to preserve, display and distribute wine.
- Interior and exterior built-in with coated stainless steel for intensive professional applications.
- Double glazed side and central walls with double-layered glass and air chamber filled with argon between them.
- Glasses and door frames heated to avoid condensations.
- Models available in two (2) colors: Black (BLA) and grey (GRE).
- For easy delivery, wine cellars are shipped in two sections: body and removable top section containing complete refrigeration unit.
- Decorative plinth included as a standard element. Shelves and hooks should be requested separately and are supplied disassembled.



MODEL	DIMENSIONS (mm)	TEMPERATURE	DEFROST	GAS	COOLING POWER (kW)	ELECTRIC POWER (kW)	FREQUENCY	REFERENCE	€
H = 2.300 mm Cellars									
FWC-2301-T1-W-L-W-GRE TR	862 x 632 x 2.300	+4 +18 °C	Electric	R290	0,74 (6)	1,275	50 Hz	19092321	-
					0,74 (6)	1,342	60 Hz	19092322	-
FWC-2301-T1-W-L-W-BLA TR	862 x 632 x 2.300	+4 +18 °C	Electric	R290	0,74 (6)	1,275	50 Hz	19092318	-
					0,74 (6)	1,342	60 Hz	19092319	-
H = 2.600 mm Cellars									
FWC-2601-T1-W-L-W-GRE TR	862 x 632 x 2.600	+4°C +18°C	Electric	R290	0,74 (6)	1,36	50 Hz	19092339	-
					0,74 (6)	1,431	60 Hz	19092340	-
FWC-2601-T1-W-L-W-BLA TR	862 x 632 x 2.600	+4°C +18°C	Electric	R290	0,74 (6)	1,36	50 Hz	19092336	-
					0,74 (6)	1,431	60 Hz	19092337	-

(6) Evap. -10°C/ Cond. 55°C

Options

			FWC-2301-T1-W (€)	FWC-2601-T1-W (€)
G type plug	CI		0	0
Lock	LC		0	0
Remote group	RG		0	0

Accessories

	REFERENCE	MODEL	BOTTLES PER SHELF	SHELF CAPACITY		BOTTLE CAPACITY		€
				H = 2.300 MM	H = 2.600 MM	H = 2.300 MM	H = 2.600 MM	
Methacrylate structure with rod shelving								
	19067947	DIM 20-23	7	9	-	63	-	-
	19067948	DIM 20-26	7	-	11	-	77	-
Methacrylate structure with rod shelving								
	19067949	DIS-90	43	3	4	129	172	-
	19067950	DIS 0-90	8	9	11	72	88	-
	19067951	DIS 0-180	8	9	11	72	88	-
	19067952	DIS-20	9	9	11	81	99	-

ADVANCE

Wall wine cellars



FWC-2602-T2-W-LR-W-GRE TR

FWC-2602-T1-W-L-W-BLA TR

- CC5
- 220-240V
- TYPE F
- LED

General characteristics

- Wine cellar specially designed to preserve, display and distribute wine.
- Interior and exterior built-in with coated stainless steel for intensive professional applications.
- Double glazed side and central walls with double-layered glass and air chamber filled with argon between them.
- Glasses and door frames heated to avoid condensations.
- Models available in two (2) colors: Black (BLA) and grey (GRE).
- For easy delivery, wine cellars are shipped in two sections: body and removable top section containing complete refrigeration unit.
- Decorative plinth included as a standard element. Shelves and hooks should be requested separately and are supplied disassembled.



MODEL	DIMENSIONS (mm)	TEMPERATURE	DEFROST	GAS	COOLING POWER (kW)	ELECTRIC POWER (kW)	FREQUENCY	REFERENCE	€
H = 2.300 mm Cellars									
FWC-2302-T1-W-LR-W-GRE TR	1.697 x 632 x 2.300	+4°C +18°C	Electric	R290	1,48 (6)	2,175	50 Hz	19092327	-
					1,48 (6)	2,29	60 Hz	19092328	-
FWC-2302-T1-W-LR-W-BLA TR	1.697 x 632 x 2.300	+4°C +18°C	Electric	R290	1,48 (6)	2,175	50 Hz	19092324	-
					1,48 (6)	2,29	60 Hz	19092325	-
FWC-2302-T2-W-LR-W-GRE TR	1.697 x 632 x 2.300	+4°C +18°C	Electric	R290	0,74 (6)	2,4	50 Hz	19092333	-
					0,74 (6)	2,526	60 Hz	19092334	-
FWC-2302-T2-W-LR-W-BLA TR	1.697 x 632 x 2.300	+4°C +18°C	Electric	R290	0,74 (6)	2,4	50 Hz	19092330	-
					0,74 (6)	2,526	60 Hz	19092331	-
H = 2.600 mm Cellars									
FWC-2602-T1-W-LR-W-GRE TR	1.697 x 632 x 2.600	+4°C +18°C	Electric	R290	1,48 (6)	2,58	50 Hz	19092345	-
					1,48 (6)	2,715	60 Hz	19092346	-
FWC-2602-T1-W-LR-W-BLA TR	1.697 x 632 x 2.600	+4°C +18°C	Electric	R290	1,48 (6)	2,58	50 Hz	19092342	-
					1,48 (6)	2,715	60 Hz	19092343	-
FWC-2602-T2-W-LR-W-GRE TR	1.697 x 632 x 2.600	+4°C +18°C	Electric	R290	0,74 (6)	2,68	50 Hz	19092351	-
					0,74 (6)	2,82	60 Hz	19092352	-
FWC-2602-T2-W-LR-W-BLA TR	1.697 x 632 x 2.600	+4°C +18°C	Electric	R290	0,74 (6)	2,68	50 Hz	19092348	-
					0,74 (6)	2,82	60 Hz	19092349	-

(6) Evap. -10°C/ Cond. 55°C

Options

			FWC-2302-T1-W (€)	FWC-2602-T1-W (€)
G type plug	CI		0	0
Lock	LC		0	0
Remote group	RG		0	0

Accessories

	REFERENCE	MODEL	BOTTLES PER SHELF	SHELF CAPACITY		BOTTLE CAPACITY		€
				H = 2.300 MM	H = 2.600 MM	H = 2.300 MM	H = 2.600 MM	
Methacrylate structure with rod shelving								
	19067947	DIM 20-23	7	18	-	63	-	-
	19067948	DIM 20-26	7	-	22	-	77	-
Methacrylate structure with rod shelving								
	19067949	DIS-90	43	6	8	258	344	-
	19067950	DIS 0-90	8	18	22	144	176	-
	19067951	DIS 0-180	8	18	22	144	176	-
	19067952	DIS-20	9	18	22	162	198	-

CONCEPT

Wine cellars



CWC-600

CWC-300

CWC-180

CC3

220-240V

TYPE F

LED

UV

General characteristics

- Exterior constructed with black coated galvanized steel and interior with sanitary thermoformed plastic with embedded inner tray slides.
- Internally designed forced draft cooling system with low consumption electronic components to guarantee optimal equipment efficiency and performance.
- Double-glazed doors insulated with low thermal emissivity to reduce heat transfer in refrigeration and UV filter for sunlight.
- Removable and height adjustable black epoxy coated grids. Wooden shelves are available under request.

	MODEL	DIMENSIONS (MM)	BOTTLE CAPACITY	TEMPERATURE (°C)	DEFROST	GAS	COOLING POWER (KW)	ELECTRIC POWER (KW)	ANNUAL CONSUMPTION (KWH)	ENERGY EFFICIENCY CLASS	FREQUENCY	REFERENCE	€
⊙ STOCK	CWC-180	506 x 579 x 941	35	+4 +18 °C	Stop	R-600a	0,199 (1)	0,101	D	423 (5)	50 Hz	19089796	-
						R-600a	0,186 (1)	0,105	-	-	60 Hz	19089797	-
⊙ STOCK	CWC-300	620 x 655 x 1.850	114	+4 +18 °C	Stop	R-600a	0,292 (1)	0,257	E	909 (5)	50 Hz	19089798	-
						R-600a	0,437 (1)	0,262	-	-	60 Hz	19089799	-
	CWC-600	1.250 x 655 x 1.850	228	+4 +18 °C	Stop	R-600a	0,584 (1)	0,513	E	1.495 (5)	50 Hz	19089800	-
						R-600a	0,437 (1)	0,523	-	-	60 Hz	19089801	-

(1) Evap. -10°C/ Cond. 45°C

(5) According to EN23953 standard

Options

			CWC-180 (€)	CWC-300 (€)	CWC-600 (€)
G type plug	CI		0	0	0

Standard Accessories

	MATERIAL	MODEL	BOTTLES PER SHELF	SHELF CAPACITY			BOTTLE CAPACITY			€	
				CWC-180	CWC-300	CWC-600	CWC-180	CWC-300	CWC-600		
		19106526	EG-180	20	1	-	-	20	-	-	-
		19106524	EG-300	30	-	3	6	-	90	180	-
		19106525	EG-30045	6	-	1	2	-	6	12	-

Other Accessories

	CODE	DESCRIPTION		€
	19045931	Wooden grid CWC-180	pc	-
	19097791	Wooden grid CWC-300	pc	-
	19097792	Wooden grid CWC-300 45°	pc	-

CONCEPT

Dry agers



FMA-1650 S FMA-1650 B FMA-900

CC3	220-240V
TYPE F	LED
UV	HACCP

General characteristics

- Interior compartment completely built with AISI-304 stainless steel.
- 10 HACCP alarms capacity which are store when high temperature variation and devices power failure.
- Double-glazed doors insulated with low thermal emissivity to reduce heat transfer in refrigeration.
- UV air sterilization lamp to prevent bacterial proliferation inside the compartment.
- Removable and height adjustable epoxy coated grids with a maximum loading capacity of up to 40 kg.



Fagor Meat Dry Ager, with a refrigeration circuit designed with its own technology, guarantees a homogeneous distribution of both temperature and interior humidity, essential to obtain maximum quality results in the maturation process, whose results have been verified by BCC Innovation, Basque Culinary Center technological center.

MODEL	DIMENSIONS (MM)	VOLUME (L)	TEMPERATURE (°C)	DEFROST	GAS	COOLING POWER (KW)	ELECTRIC POWER (KW)	FREQUENCY	REFERENCE	€
Stainless Steel exterior finishing										
FMA-900	620 x 600 x 925	149	+1 +20 °C	Stop	R-600a	0,287 (1)	0,287	50 Hz	19073881	-
					R290	0,284 (1)	0,318	60 Hz	19086165	-
FMA-1650	700 x 750 x 1.665	493	+1 +20 °C	Stop	R-600a	0,358 (1)	0,355	50 Hz	19073883	-
					R-600a	0,437 (1)	0,362	60 Hz	19079369	-
FMA-1650 S	700 x 750 x 2.050	493	+1 +20 °C	Stop	R-600a	0,358 (1)	0,355	50 Hz	19081264	-
					R-600a	0,437 (1)	0,362	60 Hz	19079440	-
Black coated exterior finishing										
FMA-900 B	620 x 600 x 925	149	+1 +20 °C	Stop	R-600a	0,325 (1)	0,325	50 Hz	19073882	-
					R290	0,284 (1)	0,318	60 Hz	19103531	-
FMA-1650 B	700 x 750 x 1.665	493	+1 +20 °C	Stop	R-600a	0,358 (1)	0,355	50 Hz	19073884	-
					R-600a	0,437 (1)	0,362	60 Hz	19100112	-
FMA-1650 BS	700 x 750 x 2.050	493	+1 +20 °C	Stop	R-600a	0,358 (1)	0,355	50 Hz	19081265	-
					R-600a	0,437 (1)	0,362	60 Hz	19105344	-

Options

			FMA-900 (€)	FMA-1650 (€)
G type plug	CI		0	0

Standard Accessories

	CODE	DESCRIPTION	900	1650	€
	19097799	Epoxy grid 482x368	pc 1	-	-
	19097804	Epoxy grid 487x582	pc -	3	-
	19097802	Epoxy grid 467x277x62,5	pc 1	-	-
	19097803	Epoxy grid 558x413x62,5	pc -	1	-
	19097798	Himalayan salt block	pc 2	4	-
	19097801	Salt block support	pc -	1	-
	19097800	Salt block support	pc 1	-	-

Other Accessories

	CODE	DESCRIPTION	€
	19081972	Kit electropolished grids FMA-900	-
	19081971	Kit electropolished grids FMA-1600	-
	19074042	Kit hanging bar + Hook FMA-900	-
	19074041	Kit hanging bar + Hook FMA-1600	-
	19081970	Black coated base FMA-900	-
	19074043	Black coated base FMA-1600	-

Fagor Professional



Ice makers

— Solid ice-cube makers.....	373
— Dice-shaped ice-cube makers	375
— Granular ice makers	377
— Nugget ice makers	379
— Flake ice makers	379
— Hollow ice-cube makers	380
— Tanks for modular	381
— Accessories	382

Special units or any variations from the standard model must be assembled at the factory at an additional charge over the standard model's price.

Please, contact Fagor Professional for any other variation or option that is not included on this list.

The minimum recommended water quality is 15 to 40°F.

WITH BUILT-IN TANK

Solid ice-cube makers



General characteristics

- Produces solid gourmet crystal clear ice cubes.
- Spray system with flexible nozzles that avoid limescale deposits with small vibrations.
- Smart front ventilation system that allows built-in installation of the unit.
- Motor pump without seals, which avoids deterioration in hard water.
- Door opening movement with damping system to avoid accidents.
- On/off lighted rocker switch in front panel.
- Specially manufactured from high quality stainless steel for intensive professional applications, featuring a very robust design and perfect finish.
- The installation of an anti-scale filter is advised in areas with medium or high limescale content (hard water), over 30 °f of hardness.
- Equipment prepared for extreme ambient temperatures (43 °C).

EFIM-30





MODEL	CONDENSATION SYSTEM	DIMENSIONS (mm)	TANK CAPACITY (kg)	PRODUCTION (kg/DAY)	N° CUBES PER CYCLE	GAS	POWER (W)	ELECTRIC CONNECTION	FREQUENCY	REFERENCE	€
L shaped cubes (14 gr)											
EFIM-20 L	Air	350 x 475 x 595	6	22	18	R290	862	220-240V	50 Hz	19107214	-
EFIM-20 L	Water	350 x 475 x 595	6	23	18	R290	862	220-240V	50 Hz	19107215	-
S shaped cubes (22 gr)											
EFIM-30 S	Air	435 x 605 x 695	15	33	24	R290	837	220-240V	50 Hz	19107216	-
EFIM-30 S	Water	435 x 605 x 695	15	37	24	R290	837	220-240V	50 Hz	19107217	-
EFIM-40 S	Air	435 x 605 x 695	15	40	24	R290	1.266	220-240V	50 Hz	19107218	-
EFIM-40 S	Water	435 x 605 x 695	15	44	24	R290	1.266	220-240V	50 Hz	19107219	-
EFIM-60 S	Air	515 x 645 x 840	30	52	36	R290	1.266	220-240V	50 Hz	19107220	-
EFIM-60 S	Water	515 x 645 x 840	30	53	36	R290	1.266	220-240V	50 Hz	19107221	-
EFIM-80 S	Air	645 x 645 x 870	40	79	48	R290	1.967	220-240V	50 Hz	19107222	-
EFIM-80 S	Water	645 x 645 x 870	40	81	48	R290	1.967	220-240V	50 Hz	19107223	-
EFIM-130 S	Air	930 x 565 x 915	60	113	72	R290	2.292	220-240V	50 Hz	19107224	-
EFIM-130 S	Water	930 x 565 x 915	60	121	72	R290	2.292	220-240V	50 Hz	19107235	-
K shaped cubes (40 gr)											
EFIM-30 K	Air	435 x 605 x 695	15	33	24	R290	975	220-240V	50 Hz	19107225	-
EFIM-30 K	Water	435 x 605 x 695	15	37	24	R290	975	220-240V	50 Hz	19107226	-
EFIM-40 K	Air	435 x 605 x 695	15	40	24	R290	1.266	220-240V	50 Hz	19107227	-
EFIM-40 K	Water	435 x 605 x 695	15	44	24	R290	1.266	220-240V	50 Hz	19107228	-
EFIM-60 K	Air	515 x 645 x 840	30	52	36	R290	1.266	220-240V	50 Hz	19107229	-
EFIM-60 K	Water	515 x 645 x 840	30	53	36	R290	1.266	220-240V	50 Hz	19107230	-
EFIM-80 K	Air	645 x 645 x 870	40	79	48	R290	1.967	220-240V	50 Hz	19107231	-
EFIM-80 K	Water	645 x 645 x 870	40	81	48	R290	1.967	220-240V	50 Hz	19107232	-
EFIM-130 K	Air	930 x 565 x 915	60	113	72	R290	2.292	220-240V	50 Hz	19107233	-
EFIM-130 K	Water	930 x 565 x 915	60	121	72	R290	2.292	220-240V	50 Hz	19107234	-

Options

		EFIM-20 (€)	EFIM-30 (€)	EFIM-40 (€)	EFIM-60 (€)	EFIM-80 (€)	EFIM-130 (€)
60 Hz version	60Hz	o	o	o	o	o	o
G type plug	Cl 	o	o	o	o	o	o
Drain pump	DP (*)	-	o	o	o	o	o

* Drain pump only available for air-cooled models.

Standard Accessories

	20	30	40	60	80	130
 Water inlet filter gasket	1	1	1	1	1	1
 Water inlet hose	1	1	1	1	1	1
 Water outlet hose	1	1	1	1	1	1
 Small scoop	1	1	1	1	1	1
 4 leg kit	-	1	1	1	1	1

MODULAR

Solid ice-cube makers



General characteristics

- Produces solid gourmet crystal clear ice cubes.
- Spray system with flexible nozzles that avoid limescale deposits with small vibrations.
- High efficiency machines with low electrical consumption.
- Stackable machines. Connection kit accessory required.
- Specially manufactured from high quality stainless steel for intensive professional applications, featuring a very robust design and perfect finish.
- The installation of an anti-scale filter is advised in areas with medium or high limescale content (hard water), over 30 °f of hardness.

EMFIM-150

MODEL	CONDENSATION SYSTEM	DIMENSIONS (mm)	TANK CAPACITY (Kg)	PRODUCTION (Kg/DAY)	N° CUBES PER CYCLE	GAS	POWER (W)	ELECTRIC CONNECTION	FREQUENCY	REFERENCE	€
S shaped cubes (22 gr)											
EMFIM-150 S	Air	775 x 625 x 805	-	154	96	R290	3.610	220-240V	50 Hz	19107236	-
EMFIM-150 S	Water	775 x 625 x 805	-	154	96	R290	3.610	220-240V	50 Hz	19107239	-
MFIM-400 S	Air	1.321 x 638 x 978	-	390	192	R-452a	13.500	220-240V	50 Hz	19107018	-
MFIM-400 S	Water	1.321 x 638 x 978	-	400	192	R-452a	13.500	220-240V	50 Hz	19107032	-
K shaped cubes (40 gr)											
EMFIM-150 K	Air	775 x 625 x 805	-	154	96	R290	3.610	220-240V	50 Hz	19107237	-
EMFIM-150 K	Water	775 x 625 x 805	-	154	96	R290	3.610	220-240V	50 Hz	19107238	-
MFIM-400 K	Air	1.321 x 638 x 978	-	390	192	R-452a	13.500	220-240V	50 Hz	19107019	-
MFIM-400 K	Water	1.321 x 638 x 978	-	400	192	R-452a	13.500	220-240V	50 Hz	19107031	-

Compatible tanks

MODEL CAPACITY	S-130 160 KG		S-160 180 KG		S-220 230 KG		S-350 340 KG	
	CODE	€	CODE	€	CODE	€	CODE	€
EMFIM-150	19082415	-	-	-	19031799	-	19082418	-
MFIM-400	-	-	-	-	-	-	-	-

MODEL CAPACITY	S-400 390 KG		S-500 480 KG		S CART 300 + 112 KG		S2CART 617 + 224 KG	
	CODE	€	CODE	€	CODE	€	CODE	€
EMFIM-150	19096225	-	19031802	-	19082382	-	19082384	-
MFIM-400	19096225	-	19031802	-	-	-	-	-

Options

		EMFIM-150 (€)	MFIM-400 (€)
60 Hz version	60Hz	o	o
G type plug	Cl	o	-

Standard Accessories

	150	400
Water inlet filter gasket	1	1
Water inlet hose	1	1
Water outlet hose	1	1
Small scoop	1	-

WITH BUILT-IN TANK

Dice-shaped ice-cube makers



General characteristics

- Produces full dice ice cubes or half dice ice cubes.
- Easy access for service and installation. All panels can be disassembled separately.
- Strong door opening system. Door made in stainless steel.
- Smart front ventilation system that allows built-in installation of the unit.
- On/off lighted rocker switch in front panel.
- Cleaning switch that allows circulation of water with descaling product without cooling.
- Electronic control that enhances the performance of the machine and allows it to adapt to extreme climates.
- Specially manufactured from high quality stainless steel for intensive professional applications, featuring a very robust design and perfect finish.
- Equipment prepared for extreme ambient temperatures (43 °C).
- Height adjustable legs from 105 mm to 155 mm.

EFICE-50

MODEL	CONDENSATION SYSTEM	DIMENSIONS (mm)	TANK CAPACITY (kg)	PRODUCTION (kg/day)	N° CUBES PER CYCLE	GAS	POWER (W)	ELECTRIC CONNECTION	FREQUENCY	REFERENCE	€
HD shaped cubes (6 gr)											
EFICE-50 HD	Air	535 x 595 x 789	20	47	75	R290	770	220-240V	50 Hz	19107202	-
EFICE-70 HD	Air	535 x 595 x 789	20	74	75	R290	1.007	220-240V	50 Hz	19107203	-
EFICE-100 HD	Air	660 x 700 x 832	35	108	120	R290	1.154	220-240V	50 Hz	19107204	-
EFICE-150 HD	Air	762 x 762 x 832	45	145	144	R290	1.868	220-240V	50 Hz	19107205	-
D shaped cubes (12 gr)											
EFICE-50 D	Air	535 x 595 x 789	20	45	75	R290	770	220-240V	50 Hz	19107208	-
EFICE-70 D	Air	535 x 595 x 789	20	76	75	R290	1.007	220-240V	50 Hz	19107209	-
EFICE-100 D	Air	660 x 700 x 832	35	99	120	R290	1.154	220-240V	50 Hz	19107210	-
EFICE-150 D	Air	762 x 762 x 832	45	145	144	R290	1.868	220-240V	50 Hz	19107211	-

Options

		EFICE-50 (€)	EFICE-70 (€)	EFICE-100 (€)	EFICE-150 (€)
60 Hz version	60Hz	o	o	o	o
G type plug	Cl	o	o	o	o
Drain pump	DP (*)	o	o	o	o

* Drain pump only available for air-cooled models.

Standard Accessories

		50	70	100	150
	Water inlet filter gasket	1	1	1	1
	Water inlet hose	1	1	1	1
	Water outlet hose	1	1	1	1
	Small scoop	1	1	1	1
	4 leg kit (adjustable height)	1	1	1	1

MODULAR

Dice-shaped ice-cube makers



General characteristics

- Produces full dice ice cubes or half dice ice cubes.
- High evaporator efficiency. Lower energy consumption and higher ice production.
- Smart water distributor that improves drop-off efficiency.
- Easy access by removing the panels with a single screwdriver.
- Smart electronic board that controls every parameter in the machine and shows the diagnosis of possible incidences.
- Specially manufactured from high quality stainless steel for intensive professional applications, featuring a very robust design and perfect finish.

EFICE-300

MODEL	CONDENSATION SYSTEM	DIMENSIONS (mm)	TANK CAPACITY (kg)	PRODUCTION (kg/day)	N° CUBES PER CYCLE	GAS	POWER (W)	ELECTRIC CONNECTION	FREQUENCY	REFERENCE	€
HD shaped cubes (6 gr)											
EFICE-200 HD	Air	762 x 620 x 500	-	220	400	R290	1.868	220-240V	50 Hz	19107206	-
EFICE-300 HD FIT	Air	559 x 621 x 659	-	300	480	R290	2.348	220-240V	50 Hz	19107207	-
FICE-400 HD	Air	762 x 620 x 760	-	405	800	R-452a	11.185	380-415V	50 Hz	19107015	-
D shaped cubes (12 gr)											
EFICE-200 D	Air	762 x 620 x 500	-	220	200	R290	1.868	220-240V	50 Hz	19107212	-
EFICE-300 D FIT	Air	559 x 621 x 659	-	300	240	R290	2.348	220-240V	50 Hz	19107213	-
FICE-400 D	Air	762 x 620 x 760	-	405	400	R-452a	11.185	380-415V	50 Hz	19107016	-

Compatible tanks

MODEL CAPACITY	S-130 160 KG CODE	€	S-160 180 KG CODE	€	S-220 230 KG CODE	€	S-350 340 KG CODE	€
EFICE-200	19082415	-	-	-	19031799	-	19082418	-
EFICE-300	19082415	-	19082417	-	19031799	-	19082418	-
FICE-400	19082415	-	-	-	19031799	-	19082418	-

MODEL CAPACITY	S-400 390 KG CODE	€	S-500 480 KG CODE	€	S CART 300 + 112 KG CODE	€	S2CART 617 + 224 KG CODE	€
EFICE-200	19096225	-	19031802	-	19082382	-	19082385	-
EFICE-300	19096225	-	19031802	-	19082382	-	19082385	-
FICE-400	19096225	-	19031802	-	19082382	-	19082385	-





MODEL	DIMENSIONS (mm)	SUITABLE FOR	CAPACITY	REFERENCE	€
Dispenser DHD	769 x 835 x 1.383	EFICE-200 FICE-400	104	19031818	-
Dispenser DHD FIT & WATER	559 x 835 x 1.218	EFICE-300	58	19082463	-

Options

		EFICE-200 (€)	EFICE-300 (€)	FICE-400 (€)
60 Hz version	60Hz	o	o	o
G type plug	Cl 	o	o	o

Standard Accessories

	200	300	400
 Water inlet filter gasket	1	1	1
 Water inlet hose	1	1	1
 Water outlet hose	1	1	1

WITH BUILT-IN TANK

Granular ice-cube makers



EGIM-85



G



TYPE F

General characteristics





- Granular ice production.
- High efficient evaporator, without gaskets or seals.
- Stainless steel auger with resilient coating to maximize lifespan.
- Powerful speed reducer on top.
- Easy access for service and installation. All panels can be disassembled separately.
- Strong door opening system. Door made in stainless steel.
- Smart front ventilation system that allows built-in installation of the unit.
- On/off lighted rocker switch in front panel.
- Cleaning switch: disconnects the cooling system while circulating water with descaling product.
- Specially manufactured from high quality stainless steel for intensive professional applications, featuring a very robust design and perfect finish.
- Equipment prepared for extreme ambient temperatures (43 °C).
- The installation of an anti-scale filter is advised in areas with medium or high limescale content (hard water), over 30 °f of hardness.
- Height adjustable legs from 105 mm to 155 mm.

MODEL	CONDENSATION SYSTEM	DIMENSIONS (mm)	TANK CAPACITY (kg)	PRODUCTION (kg/day)	N° CUBES PER CYCLE	GAS	POWER (W)	ELECTRIC CONNECTION	FREQUENCY	REFERENCE	€
EGIM-45	Air	465 x 595 x 784	20	55	-	R290	679	220-240V	50 Hz	19107174	-
EGIM-45	Water	465 x 595 x 784	20	78	-	R290	679	220-240V	50 Hz	19107182	-
EGIM-85	Air	465 x 595 x 784	20	95	-	R290	758	220-240V	50 Hz	19107175	-
EGIM-85	Water	465 x 595 x 784	20	95	-	R290	758	220-240V	50 Hz	19107177	-
EGIM-135	Air	515 x 550 x 1.355	64	178	-	R290	1.267	220-240V	50 Hz	19107176	-
EGIM-135	Water	515 x 550 x 1.355	64	202	-	R290	1.267	220-240V	50 Hz	19107185	-

Options

		EGIM-45 (€)	EGIM-85 (€)	EGIM-135 (€)
60 Hz version	60Hz	o	o	o
G type plug	Cl 	o	o	o

Standard Accessories

	45	85	135
 Water inlet filter gasket	1	1	1
 Water inlet hose	1	1	1
 Water outlet hose	1	1	1
 Small scoop	1	1	1
 4 leg kit (adjustable height)	1	1	-

MODULAR

Granular ice-cube makers



General characteristics

- Granular ice production.
- Ice drops out through the opening on the bottom of the unit.
- High efficient evaporator, without gaskets or seals.
- Stainless steel auger with resilient coating to maximize lifespan.
- Powerful speed reducer on top.
- Electromechanical control system.
- On/off lighted rocker switch in the front panel.
- Specially manufactured from high quality stainless steel for intensive professional applications, featuring a very robust design and perfect finish.
- The installation of an anti-scale filter is advised in areas with medium or high limescale content (hard water), over 30 °f of hardness.
- Equipment prepared for extreme ambient temperatures (43 °C).

EMGIM-200

MODEL	CONDENSATION SYSTEM	DIMENSIONS (mm)	TANK CAPACITY (kg)	PRODUCTION (kg/day)	N° CUBES PER CYCLE	GAS	POWER (W)	ELECTRIC CONNECTION	FREQUENCY	REFERENCE	€
EMGIM-150	Air	515 x 550 x 1.355	-	182	-	R290	1.266	220-240V	50 Hz	19107178	-
EMGIM-150	Water	515 x 550 x 1.355	-	202	-	R290	1.266	220-240V	50 Hz	19107183	-
EMGIM-200	Air	515 x 550 x 575	-	230	-	R290	1.651	220-240V	50 Hz	19107179	-
EMGIM-200	Water	515 x 550 x 575	-	211	-	R290	1.651	220-240V	50 Hz	19107189	-
EMGIM-400	Air	675 x 550 x 660	-	482	-	R290	3.620	220-240V	50 Hz	19107180	-
EMGIM-400	Water	675 x 550 x 660	-	541	-	R290	3.620	220-240V	50 Hz	19107186	-
EMGIM-500	Air	675 x 550 x 800	-	655	-	R290	5.218	380-415V	50 Hz	19107273	-
EMGIM-500	Water	675 x 550 x 800	-	620	-	R290	5.218	380-415V	50 Hz	19107276	-

Compatible tanks

MODEL CAPACITY	S-130 160 KG		S-160 180 KG		S-220 230 KG		S-350 340 KG						
	CODE	€	CODE	€	CODE	€	CODE	€					
EMGIM-150		19082414	-		19082416	-		19031843	-			19082374	-
EMGIM-200		19082414	-		19082416	-		19031843	-			19082374	-
EMGIM-400		19082414	-		19082416	-		19031843	-			19082374	-
EMGIM-500		19082414	-		19082416	-		19031843	-			19082374	-

MODEL CAPACITY	S-400 390 KG		S-500 480 KG		S CART 300 + 112 KG		S2CART 617 + 224 KG						
	CODE	€	CODE	€	CODE	€	CODE	€					
EMGIM-150		19096224	-		19031844	-		19082380	-			19082383	-
EMGIM-200		19096224	-		19031844	-		19082380	-			19082383	-
EMGIM-400		19096224	-		19031844	-		19082380	-			19082383	-
EMGIM-500		19096224	-		19031844	-		19082380	-			19082383	-

Options

		EMGIM-150 (€)	EMGIM-200 (€)	EMGIM-400 (€)	EMGIM-500 (€)
60 Hz version	60Hz	o	o	o	o
G type plug	Cl	o	o	o	-

Standard Accessories

		150	200	400	500
	Water inlet filter gasket	1	1	1	1
	Water inlet hose	1	1	1	1
	Water outlet hose	1	1	1	1

MODULAR

Nugget ice-cube makers



ENGIM-300



General characteristics

- Nugget ice production.
- Ice drops out through the opening on the bottom of the unit.
- High evaporator efficiency. Lower energy consumption and higher ice production.
- Stainless steel auger with resilient coating to maximize lifespan.
- Powerful speed reducer on top.
- Optical pinpoint control system to set ice stock level.
- On/off lighted rocker switch in the front panel.
- Autodiagnosis led lights signaling operation status & alerts.
- Specially manufactured from high quality stainless steel for intensive professional applications, featuring a very robust design and perfect finish.
- The installation of an anti-scale filter is advised in areas with medium or high limescale content (hard water), over 30 °f of hardness.
- Equipment prepared for extreme ambient temperatures (43 °C).

MODEL	CONDENSATION SYSTEM	DIMENSIONS (mm)	TANK CAPACITY (kg)	PRODUCTION (kg/day)	N° CUBES PER CYCLE	GAS	POWER (W)	ELECTRIC CONNECTION	FREQUENCY	REFERENCE	€
ENGIM-300	Air	559 x 622 x 712	-	310	-	R290	3.240	220-240V	50 Hz	19107190	-

Compatible tanks

MODEL/CAPACITY	S-130/ 160 KG	S-160/ 180 KG	S-220/ 230 KG	S-350/ 340 KG
MODEL/CAPACITY	S-400/ 390 KG	S-500/ 480 KG	S CART/ 300 + 112 KG	S2CART/ 617 + 224 KG
ENGIM-300	19082414	19082416	19031843	19082374
ENGIM-300	19096224	19031844	19082380	19082383

Options

			ENGIM-300 (€)
60 Hz version	60Hz		0
G type plug	Cl		0

Standard Accessories

		300
	Water inlet filter gasket	1
	Water inlet hose	1
	Water outlet hose	1

Flake ice-cube makers



FLAKE-1000



General characteristics

- Cold and dry flat flakes production. Flake thickness may be adjusted between 1.5 mm and 3 mm.
- Based on a static cylinder which is free from swivel joints (helical reamer) coupled with a milling tool that detaches the ice without any strained or forced movements.
- High evaporator efficiency. Lower energy consumption and higher ice production.
- Powerful speed reducer on top.
- Magnetic drive pump.
- Electronic stop system.
- Controllers to detect: low water level, temperature rise due to motor overload or full vat.
- Specially manufactured from high quality stainless steel for intensive professional applications.

MODEL	CONDENSATION SYSTEM	DIMENSIONS (mm)	TANK CAPACITY (kg)	PRODUCTION (kg/day)	N° CUBES PER CYCLE	GAS	POWER (W)	ELECTRIC CONNECTION	FREQUENCY	REFERENCE	€
FLAKE 1000	Air	1.340 x 1.150 x 870	-	1.000	-	R-452a	5.500	380-415V	50 Hz	19082465	-

Compatible tanks

MODEL/CAPACITY	S-400/ 390 KG	S-500/ 480 KG	S CART/ 300 + 112 KG	S2CART/ 617 + 224 KG
FLAKE 1000	-	-	-	19082383

Options

			FLAKE-1000 (€)
60 Hz version	60Hz		0

Standard Accessories

		1000
	Water inlet filter gasket	1
	Water inlet hose	1
	Water outlet hose	1

WITH BUILT-IN TANK

Hollow ice-cube makers



EFIM-60 C



General characteristics

- Produces a semi-hollow cube with a greater surface that cools faster the drink.
- Paddle system to produce ice in the most adverse conditions of water quality (hardwater) and in the least adequate sites.
- Paddle system that makes water filters unnecessary, avoiding their costs.
- Water movement thanks to paddles grants that the purest water touches the evaporator and get frozen, obtaining the clearest ice cube.
- Designed without thermostat, avoiding problems & getting all ice is possible.
- Without timer. Detection of end of cycle and full bin are detected through mechanical devices.
- Door-opening movement dampening system to avoid accidents.
- On/off lighted rocker switch in front panel.
- Specially manufactured from high quality stainless steel for intensive professional applications, featuring a very robust design and perfect finish.
- Equipment prepared for extreme ambient temperatures (43 °C).

MODEL	CONDENSATION SYSTEM	DIMENSIONS (mm)	TANK CAPACITY (kg)	PRODUCTION (kg/day)	N° CUBES PER CYCLE	GAS	POWER (W)	ELECTRIC CONNECTION	FREQUENCY	REFERENCE	€
EFIM-20 C	Air	401 x 506 x 643	6	24	15	R290	778	220-240V	50 Hz	19107192	-
EFIM-20 C	Water	401 x 506 x 643	6	24	15	R290	778	220-240V	50 Hz	19107193	-
EFIM-30 C	Air	401 x 506 x 698	12	38	25	R290	778	220-240V	50 Hz	19107194	-
EFIM-30 C	Water	401 x 506 x 698	12	38	25	R290	778	220-240V	50 Hz	19107195	-
EFIM-40 C	Air	401 x 506 x 698	12	40	25	R290	404	220-240V	50 Hz	19107196	-
EFIM-40 C	Water	401 x 506 x 698	12	40	25	R290	404	220-240V	50 Hz	19107197	-
EFIM-60 C	Air	594 x 557 x 934	30	63	45	R290	1.266	220-240V	50 Hz	19107198	-
EFIM-60 C	Water	594 x 557 x 934	30	66	45	R290	1.266	220-240V	50 Hz	19107199	-
EFIM-90 C	Air	674 x 557 x 984	37	83	55	R290	1.804	220-240V	50 Hz	19107200	-
EFIM-90 C	Water	674 x 557 x 984	37	83	55	R290	1.804	220-240V	50 Hz	19107191	-
EFIM-130 C	Air	844 x 557 x 984	50	119	80	R290	2.292	220-240V	50 Hz	19107201	-
EFIM-130 C	Water	844 x 557 x 984	50	114	80	R290	2.292	220-240V	50 Hz	19107240	-

Options

		EFIM-20 C (€)	EFIM-30 C (€)	EFIM-40 C (€)	EFIM-60 C (€)	EFIM-90 C (€)	EFIM-130 C (€)
60 Hz version	60Hz	0	0	0	0	0	0
G type plug	CI	0	0	0	0	0	0

Standard Accessories

	20	30	40	60	90	130
Water inlet filter gasket	1	1	1	1	1	1
Water inlet hose	1	1	1	1	1	1
Water outlet hose	1	1	1	1	1	1
Small scoop	1	1	1	1	1	1
4 leg kit (adjustable height)	-	1	1	1	1	1

Tanks for modular ice-cube makers (Silos)



S-160

S-CART 300

General characteristics

- Specially manufactured from high quality stainless steel for intensive professional applications, featuring a very robust design and perfect finish.
- Very hard sanitary polyethylene vat, resistant to blows, and scratches.
- Seamless one-piece vat with rounded corners, avoiding possible dirty points and facilitating cleaning.
- Drainage system that collects and drives the water to the drain keeping the bin clean and dry.

Specific features: Tanks with trolley











- Ergonomic, easy to move with little effort.
- It has a braking and drainage system.
- Made of sanitary polyethylene, with smooth surface to facilitate cleaning.
- Includes a cover to prevent dirt from contaminating the ice.
- Buckets for distributing ice quickly and effortlessly can be included.

MODEL	DIMENSIONS (mm)	TANK CAPACITY (kg)	SUITABLE FOR	REFERENCE	€
Tanks					
S-130	762 x 819 x 740	160	FICE	19082415	-
			MGIM / NGIM	19082414	-
S-160	559 x 872 x 1.122	180	FICE	19082417	-
			MGIM / NGIM	19082416	-
S-220	762 x 819 x 1.071	230	MFIM / FICE	19031799	-
			MGIM / NGIM	19031843	-
S-350	1.067 x 819 x 1.071	340	MFIM / FICE	19082418	-
			MGIM	19082374	-
S-400	1.219 x 819 x 1.071	390	MFIM / FICE	19096225	-
			S400 MGIM	19096224	-
S-500	1.321 x 872 x 1.122	480	MFIM / FICE	19031802	-
			MGIM	19031844	-
Tanks with trolley					
SCART	762 x 1.016 x 1.865	300 + 112	MFIM / FICE	19082382	-
			MGIM / NGIM	19082380	-
S2CART	1.524 x 1.016 x 1.820	617 + 224	MFIM	19082384	-
			FICE	19082385	-
			MGIM / NGIM	19082383	-

Standard Accessories

	TANKS	TANKS WITH TROLLEY
Water outlet hose	1	1
Drainage elbow	1	-
Large scoop	1	1
4 leg kit (adjustable height)	1	-
Ice paddle	-	1
Ice paddle support	-	1

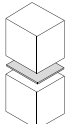
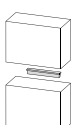
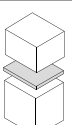
Accessories

	MODEL	DESCRIPTION	REFERENCE	€
Filters				
	FC-100	Lime scale filter for ice makers.	19038797	-
	FP-100	Particles filter for ice makers.	19038798	-
	CC-100	Replacement cartridge for ice makers.	19038799	-
	CP-100	Replacement cartridge for ice makers.	19038800	-
	CS-101	Anti-scale, active carbon and particle filter for ice makers.	19031839	-
	CS-102	Anti-scale, active carbon and particle filter for ice makers.	19082428	-
Shovels				
	SMALL SHOVEL	Small shovel for ice makers.	19082429	-
	MEDIUM SHOVEL	Medium shovel for ice makers.	19082462	-
Stacking kits				
	STACKING KIT EMFIM 150	Stacking kit for EMFIM-150 solid ice makers.	19082425	-
	STACKING KIT MFIM 400	Stacking kit for MFIM-400 solid ice makers.	19082426	-
	STACKING KIT FICE	Stacking kit for FICE dice ice makers.	19082427	-
Crusher				
	ICE CRUSHER	Ice crusher.	19082464	-